



# Commercial Vehicle Air Spring Catalogue

*3rd Edition*

# Contents

Introduction / 1

Air Spring Components / 2

Air Spring Styles & Identification / 3

Bus Air Springs / 4

Towing vehicle & Trailer & Semitrailer Air Springs / 11

Driver's Cab & Seat Air Springs / 58

Problems, Causes & Solutions / 60

Preventive Maintenance of Air Springs / 63



# A driving experience that makes every trip a pleasure!

## QUALITY

Air springs appear simple, yet they are actually a highly sophisticated and complex product.

Wherever you are, Fengmao air springs are built to meet the most exacting standards. We have more than three decades of experience working with high-strength fabrics and rubber compounds, and the rubber formulations are optimized to enable us to provide you with air springs that are built to last. For your confidence, Fengmao air springs are manufactured according to OEM standards and rigorously tested. Adhering to a quality policy of "Always be responsible for the brand and always satisfy our customers", experience effortless security in purchasing and usage of our products.

## RELIABILITY

Quality is the lifeblood of our enterprise, and our products are always consistent whether they are for the OEM or aftermarket. In fact, our air springs often outlast other maintenance components of the suspension system. We have the industry's first-class manufacturing equipment, advanced manufacturing process, under the control of a perfect quality management system, to provide a guarantee for the durability and quality of our products. Wherever your journey takes you, Fengmao Air Springs ensure a seamless journey.

## SERVICE

We take pride not just in our highquality products, but also in our service to our customers and the industry. We are dedicated to providing the best service to our customers and the market. Our mission is to provide our distributors and end customers with training and product identification assistance, such as this application guide, as well as any other replacement needs. Fengmao is your reliable partner.

## Rolling Spring

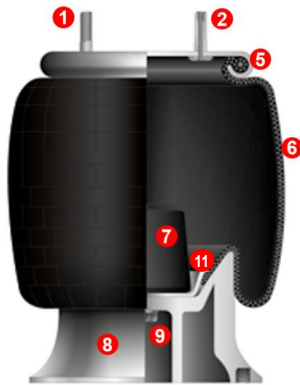

## Convolute Spring

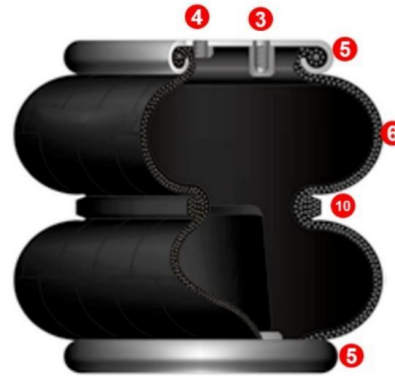

### 1. Stud

A permanent part of the bead plate assembly, used to attach the air spring to the suspension.

### 2. Combo Stud

Combination mounting stud and air fitting.

### 3. Blind Nut

A permanent part of the bead plate assembly, used to attach the air spring to the suspension.

### 4. Air Fitting Hole

A tapped hole that provides an air entrance for the part.

### 5. Bead Plate

Steel plate, permanently crimped to the bellows to form an airtight assembly.

### 6. Bellows

The air spring bellows is a flexible, airtight composite of rubber and reinforced fabric, which allows the assembly to roll up and down, providing an air-cushioned spring effect within the suspension.

### 7. Bumper (Optional)

A solid, molded rubber fail-safe device used on many suspension applications. Prevents excessive damage to vehicle and suspension in the case of sudden air pressure loss.

### 8. Piston

The piston of sleeve air spring made from aluminum, steel, or fiber reinforced composite. Provides lower mounting arrangement for the air spring in the form of tapped holes or studs.

### 9. Piston Bolt

Attaches the piston to the bellows assembly. Extended on the bottom of the piston, in some cases, to serve as a means of attaching the spring to the suspension.

### 10. Girdle Hoop

A ring molded into the bellows of the convoluted type air spring.

### 11. End Closure

Steel plate, formed by vulcanisation with the bellow to form an airtight assembly and connected to the piston.



**1** FM18003.C01 **2**

| Competitor code                    |
|------------------------------------|
| Firestone<br>1T66F<br>W01-M58-0966 |
| ContiTech<br>881 MB P30            |
| VIBRACOUSTIC<br>V 1 DK 32 X 9      |
| GOODYEAR<br>1R14-712               |

| Code           | Manufacturer |
|----------------|--------------|
| 05.429.40.47.1 | BPW 36       |
| 05.429.40.50.1 | BPW 36       |
| 05.429.40.61.1 | BPW 36       |
| 05.429.41.21.1 | BPW 36       |
| 05.429.41.36.1 | BPW 36       |
| 05.429.41.42.1 | BPW 36       |
| 05.429.40.02.0 | BPW 36       |
| 05.429.40.02.1 | BPW 36       |
| 05.429.40.08.1 | BPW 36       |

Piston: Steel **8**

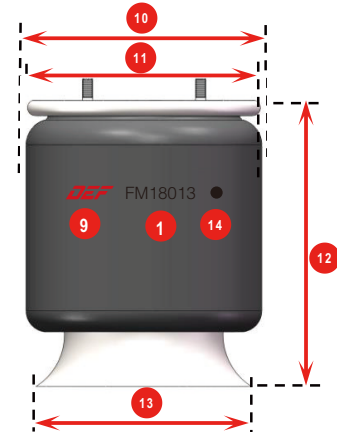

## 1. Bellows Number

Identifies the bellows, normally molded directly to the right of the Fengmao logo “FED”.

## 2. Assembly Order Number

Located on the label adhered to the bead plate. This number is used for ordering purposes.

## 3. Replacement Product Number

Competitor item numbers to make replacement products easy to find.

## 4. Cross Section View

Includes dimensional information in millimeter for uninflated diameter, maximum height, and collapsed height.

## 5. Bead Plate Top View

Identifies dimensional information in millimeter, mounting attachments.

## 6. Piston Bottom View

Includes dimensional information in millimeter, mounting attachments.

## 7. Applications

Vehicle and suspension manufacturers’ part numbers for the particular Fengmao spring.

## 8. Piston

Aluminum, Steel, or Composite.

## 9. Fengmao logo “FED”

## 10. Bellows diameter (uninflated)

## 11. Bead plate diameter

## 12. Height (uninflated)

Maximum extended & Minimum collapsed

## 13. Piston diameter

## 14. Manufacturing date

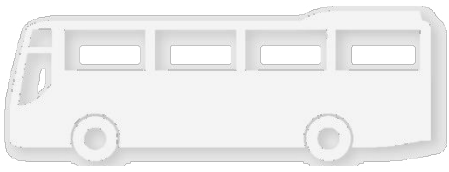

**BUS AIR SPRING**





| Code  | Section, Top View, Bottom View | Applications                              |                    |                          |                  |  |   |      |              |               |         |                 |         |                 |         |                |                |                |                |                |                |                |                |                |                |                            |               |  |         |              |         |            |          |           |       |
|---|--------------------------------|---|--------------------|--------------------------|------------------|--|---|------|--------------|---------------|---------|-----------------|---------|-----------------|---------|----------------|----------------|----------------|----------------|----------------|----------------|----------------|----------------|----------------|----------------|----------------------------|---------------|--|---------|--------------|---------|------------|----------|-----------|-------|
| <b>FM18008.N</b>  |                                |   |                    |                          |                  |  |   |      |              |               |         |                 |         |                 |         |                |                |                |                |                |                |                |                |                |                |                            |               |  |         |              |         |            |          |           |       |
| <table border="1"> <tr><td>Competitor code</td></tr> <tr><td>Firestone<br/>1R3M 340 340<br/>W01-095-0205</td></tr> <tr><td>ContiTech<br/>701 N</td></tr> <tr><td>VIBRACOUSTIC<br/>V 1 E 26</td></tr> <tr><td>GOODYEAR<br/>9006</td></tr> </table> | Competitor code                | Firestone<br>1R3M 340 340<br>W01-095-0205 | ContiTech<br>701 N | VIBRACOUSTIC<br>V 1 E 26 | GOODYEAR<br>9006 |  | <table border="1"> <thead> <tr> <th>Code</th> <th>Manufacturer</th> </tr> </thead> <tbody> <tr> <td>B 510040</td> <td>BOVA</td> </tr> <tr> <td>B 510040</td> <td>IKARUS</td> </tr> </tbody> </table>  | Code | Manufacturer | B 510040      | BOVA    | B 510040        | IKARUS  |                 |         |                |                |                |                |                |                |                |                |                |                |                            |               |  |         |              |         |            |          |           |       |
| Competitor code   |                                |   |                    |                          |                  |  |   |      |              |               |         |                 |         |                 |         |                |                |                |                |                |                |                |                |                |                |                            |               |  |         |              |         |            |          |           |       |
| Firestone<br>1R3M 340 340<br>W01-095-0205   |                                |   |                    |                          |                  |  |   |      |              |               |         |                 |         |                 |         |                |                |                |                |                |                |                |                |                |                |                            |               |  |         |              |         |            |          |           |       |
| ContiTech<br>701 N  |                                |   |                    |                          |                  |  |   |      |              |               |         |                 |         |                 |         |                |                |                |                |                |                |                |                |                |                |                            |               |  |         |              |         |            |          |           |       |
| VIBRACOUSTIC<br>V 1 E 26  |                                |   |                    |                          |                  |  |   |      |              |               |         |                 |         |                 |         |                |                |                |                |                |                |                |                |                |                |                            |               |  |         |              |         |            |          |           |       |
| GOODYEAR<br>9006  |                                |   |                    |                          |                  |  |   |      |              |               |         |                 |         |                 |         |                |                |                |                |                |                |                |                |                |                |                            |               |  |         |              |         |            |          |           |       |
| Code  | Manufacturer                   |   |                    |                          |                  |  |   |      |              |               |         |                 |         |                 |         |                |                |                |                |                |                |                |                |                |                |                            |               |  |         |              |         |            |          |           |       |
| B 510040  | BOVA                           |   |                    |                          |                  |  |   |      |              |               |         |                 |         |                 |         |                |                |                |                |                |                |                |                |                |                |                            |               |  |         |              |         |            |          |           |       |
| B 510040  | IKARUS                         |   |                    |                          |                  |  |   |      |              |               |         |                 |         |                 |         |                |                |                |                |                |                |                |                |                |                |                            |               |  |         |              |         |            |          |           |       |
| <b>FM18009.N</b>  |                                |   |                    |                          |                  |  |   |      |              |               |         |                 |         |                 |         |                |                |                |                |                |                |                |                |                |                |                            |               |  |         |              |         |            |          |           |       |
| <table border="1"> <tr><td>Competitor code</td></tr> <tr><td>Firestone<br/>1R1C 390 310<br/>W01-095-4058</td></tr> <tr><td>ContiTech<br/>661 N</td></tr> <tr><td>VIBRACOUSTIC<br/>V 1 E 25</td></tr> <tr><td>GOODYEAR<br/>8018</td></tr> </table> | Competitor code                | Firestone<br>1R1C 390 310<br>W01-095-4058 | ContiTech<br>661 N | VIBRACOUSTIC<br>V 1 E 25 | GOODYEAR<br>8018 |  | <table border="1"> <thead> <tr> <th>Code</th> <th>Manufacturer</th> </tr> </thead> <tbody> <tr><td>546 905 134</td><td>BÜSSING</td></tr> <tr><td>831 120 144</td><td>BÜSSING</td></tr> <tr><td>A 410 327 00 01</td><td>EVO BUS</td></tr> <tr><td>536 905 265</td><td>HANOMAG</td></tr> <tr><td>4746733</td><td>IVECO</td></tr> <tr><td>41822247</td><td>IVECO</td></tr> <tr><td>4.731.012.000</td><td>KÄSSBOHRER</td></tr> <tr><td>4.731.031.000</td><td>KÄSSBOHRER</td></tr> <tr><td>0249 8667</td><td>MAGIRUS-DEUTZ</td></tr> <tr><td>90.83112.0144</td><td>MAN</td></tr> <tr><td>AA 10-01-001</td><td>NEOPLAN</td></tr> <tr><td>624319-690</td><td>VAN HOOL</td></tr> <tr><td>1 137 888</td><td>VOLVO</td></tr> </tbody> </table>  | Code | Manufacturer | 546 905 134   | BÜSSING | 831 120 144     | BÜSSING | A 410 327 00 01 | EVO BUS | 536 905 265    | HANOMAG        | 4746733        | IVECO          | 41822247       | IVECO          | 4.731.012.000  | KÄSSBOHRER     | 4.731.031.000  | KÄSSBOHRER     | 0249 8667                  | MAGIRUS-DEUTZ | 90.83112.0144                          | MAN     | AA 10-01-001 | NEOPLAN | 624319-690 | VAN HOOL | 1 137 888 | VOLVO |
| Competitor code   |                                |   |                    |                          |                  |  |   |      |              |               |         |                 |         |                 |         |                |                |                |                |                |                |                |                |                |                |                            |               |  |         |              |         |            |          |           |       |
| Firestone<br>1R1C 390 310<br>W01-095-4058   |                                |   |                    |                          |                  |  |   |      |              |               |         |                 |         |                 |         |                |                |                |                |                |                |                |                |                |                |                            |               |  |         |              |         |            |          |           |       |
| ContiTech<br>661 N  |                                |   |                    |                          |                  |  |   |      |              |               |         |                 |         |                 |         |                |                |                |                |                |                |                |                |                |                |                            |               |  |         |              |         |            |          |           |       |
| VIBRACOUSTIC<br>V 1 E 25  |                                |   |                    |                          |                  |  |   |      |              |               |         |                 |         |                 |         |                |                |                |                |                |                |                |                |                |                |                            |               |  |         |              |         |            |          |           |       |
| GOODYEAR<br>8018  |                                |   |                    |                          |                  |  |   |      |              |               |         |                 |         |                 |         |                |                |                |                |                |                |                |                |                |                |                            |               |  |         |              |         |            |          |           |       |
| Code  | Manufacturer                   |   |                    |                          |                  |  |   |      |              |               |         |                 |         |                 |         |                |                |                |                |                |                |                |                |                |                |                            |               |  |         |              |         |            |          |           |       |
| 546 905 134   | BÜSSING                        |   |                    |                          |                  |  |   |      |              |               |         |                 |         |                 |         |                |                |                |                |                |                |                |                |                |                |                            |               |  |         |              |         |            |          |           |       |
| 831 120 144   | BÜSSING                        |   |                    |                          |                  |  |   |      |              |               |         |                 |         |                 |         |                |                |                |                |                |                |                |                |                |                |                            |               |  |         |              |         |            |          |           |       |
| A 410 327 00 01   | EVO BUS                        |   |                    |                          |                  |  |   |      |              |               |         |                 |         |                 |         |                |                |                |                |                |                |                |                |                |                |                            |               |  |         |              |         |            |          |           |       |
| 536 905 265   | HANOMAG                        |   |                    |                          |                  |  |   |      |              |               |         |                 |         |                 |         |                |                |                |                |                |                |                |                |                |                |                            |               |  |         |              |         |            |          |           |       |
| 4746733   | IVECO                          |   |                    |                          |                  |  |   |      |              |               |         |                 |         |                 |         |                |                |                |                |                |                |                |                |                |                |                            |               |  |         |              |         |            |          |           |       |
| 41822247  | IVECO                          |   |                    |                          |                  |  |   |      |              |               |         |                 |         |                 |         |                |                |                |                |                |                |                |                |                |                |                            |               |  |         |              |         |            |          |           |       |
| 4.731.012.000   | KÄSSBOHRER                     |   |                    |                          |                  |  |   |      |              |               |         |                 |         |                 |         |                |                |                |                |                |                |                |                |                |                |                            |               |  |         |              |         |            |          |           |       |
| 4.731.031.000   | KÄSSBOHRER                     |   |                    |                          |                  |  |   |      |              |               |         |                 |         |                 |         |                |                |                |                |                |                |                |                |                |                |                            |               |  |         |              |         |            |          |           |       |
| 0249 8667   | MAGIRUS-DEUTZ                  |   |                    |                          |                  |  |   |      |              |               |         |                 |         |                 |         |                |                |                |                |                |                |                |                |                |                |                            |               |  |         |              |         |            |          |           |       |
| 90.83112.0144   | MAN                            |   |                    |                          |                  |  |   |      |              |               |         |                 |         |                 |         |                |                |                |                |                |                |                |                |                |                |                            |               |  |         |              |         |            |          |           |       |
| AA 10-01-001  | NEOPLAN                        |   |                    |                          |                  |  |   |      |              |               |         |                 |         |                 |         |                |                |                |                |                |                |                |                |                |                |                            |               |  |         |              |         |            |          |           |       |
| 624319-690  | VAN HOOL                       |   |                    |                          |                  |  |   |      |              |               |         |                 |         |                 |         |                |                |                |                |                |                |                |                |                |                |                            |               |  |         |              |         |            |          |           |       |
| 1 137 888   | VOLVO                          |   |                    |                          |                  |  |   |      |              |               |         |                 |         |                 |         |                |                |                |                |                |                |                |                |                |                |                            |               |  |         |              |         |            |          |           |       |
| <b>FM18012.N</b>  |                                |   |                    |                          |                  |  |   |      |              |               |         |                 |         |                 |         |                |                |                |                |                |                |                |                |                |                |                            |               |  |         |              |         |            |          |           |       |
| <table border="1"> <tr><td>Competitor code</td></tr> <tr><td>Firestone<br/>1R1C 335-310<br/>W01-095-0087</td></tr> <tr><td>ContiTech<br/>715 N</td></tr> <tr><td>VIBRACOUSTIC<br/>V 1 F 25</td></tr> <tr><td>GOODYEAR<br/>8015</td></tr> </table> | Competitor code                | Firestone<br>1R1C 335-310<br>W01-095-0087 | ContiTech<br>715 N | VIBRACOUSTIC<br>V 1 F 25 | GOODYEAR<br>8015 |  | <table border="1"> <thead> <tr> <th>Code</th> <th>Manufacturer</th> </tr> </thead> <tbody> <tr><td>659561/683392</td><td>DAF</td></tr> <tr><td>4456111/4763473</td><td>VECO</td></tr> <tr><td>81.436.010.059</td><td rowspan="10">MAN</td></tr> <tr><td>81.436.010.060</td></tr> <tr><td>81.436.010.061</td></tr> <tr><td>81.436.010.075</td></tr> <tr><td>81.436.010.078</td></tr> <tr><td>81.436.010.081</td></tr> <tr><td>81.436.010.083</td></tr> <tr><td>81.436.010.090</td></tr> <tr><td>81.436.010.113</td></tr> <tr><td>81.436.010.115</td></tr> <tr><td>81.436.010.117</td></tr> <tr><td>A3632290001<br/>A3633280001</td><td>MERCEDES-BENZ</td></tr> <tr><td>V.I.5.000.786.901<br/>V.I.5.000.819.517</td><td>RENAULT</td></tr> <tr><td>6885533</td><td>VOLVO</td></tr> </tbody> </table> | Code | Manufacturer | 659561/683392 | DAF     | 4456111/4763473 | VECO    | 81.436.010.059  | MAN     | 81.436.010.060 | 81.436.010.061 | 81.436.010.075 | 81.436.010.078 | 81.436.010.081 | 81.436.010.083 | 81.436.010.090 | 81.436.010.113 | 81.436.010.115 | 81.436.010.117 | A3632290001<br>A3633280001 | MERCEDES-BENZ | V.I.5.000.786.901<br>V.I.5.000.819.517 | RENAULT | 6885533      | VOLVO   |            |          |           |       |
| Competitor code   |                                |   |                    |                          |                  |  |   |      |              |               |         |                 |         |                 |         |                |                |                |                |                |                |                |                |                |                |                            |               |  |         |              |         |            |          |           |       |
| Firestone<br>1R1C 335-310<br>W01-095-0087   |                                |   |                    |                          |                  |  |   |      |              |               |         |                 |         |                 |         |                |                |                |                |                |                |                |                |                |                |                            |               |  |         |              |         |            |          |           |       |
| ContiTech<br>715 N  |                                |   |                    |                          |                  |  |   |      |              |               |         |                 |         |                 |         |                |                |                |                |                |                |                |                |                |                |                            |               |  |         |              |         |            |          |           |       |
| VIBRACOUSTIC<br>V 1 F 25  |                                |   |                    |                          |                  |  |   |      |              |               |         |                 |         |                 |         |                |                |                |                |                |                |                |                |                |                |                            |               |  |         |              |         |            |          |           |       |
| GOODYEAR<br>8015  |                                |   |                    |                          |                  |  |   |      |              |               |         |                 |         |                 |         |                |                |                |                |                |                |                |                |                |                |                            |               |  |         |              |         |            |          |           |       |
| Code  | Manufacturer                   |   |                    |                          |                  |  |   |      |              |               |         |                 |         |                 |         |                |                |                |                |                |                |                |                |                |                |                            |               |  |         |              |         |            |          |           |       |
| 659561/683392   | DAF                            |   |                    |                          |                  |  |   |      |              |               |         |                 |         |                 |         |                |                |                |                |                |                |                |                |                |                |                            |               |  |         |              |         |            |          |           |       |
| 4456111/4763473   | VECO                           |   |                    |                          |                  |  |   |      |              |               |         |                 |         |                 |         |                |                |                |                |                |                |                |                |                |                |                            |               |  |         |              |         |            |          |           |       |
| 81.436.010.059  | MAN                            |   |                    |                          |                  |  |   |      |              |               |         |                 |         |                 |         |                |                |                |                |                |                |                |                |                |                |                            |               |  |         |              |         |            |          |           |       |
| 81.436.010.060  |                                |   |                    |                          |                  |  |   |      |              |               |         |                 |         |                 |         |                |                |                |                |                |                |                |                |                |                |                            |               |  |         |              |         |            |          |           |       |
| 81.436.010.061  |                                |   |                    |                          |                  |  |   |      |              |               |         |                 |         |                 |         |                |                |                |                |                |                |                |                |                |                |                            |               |  |         |              |         |            |          |           |       |
| 81.436.010.075  |                                |   |                    |                          |                  |  |   |      |              |               |         |                 |         |                 |         |                |                |                |                |                |                |                |                |                |                |                            |               |  |         |              |         |            |          |           |       |
| 81.436.010.078  |                                |   |                    |                          |                  |  |   |      |              |               |         |                 |         |                 |         |                |                |                |                |                |                |                |                |                |                |                            |               |  |         |              |         |            |          |           |       |
| 81.436.010.081  |                                |   |                    |                          |                  |  |   |      |              |               |         |                 |         |                 |         |                |                |                |                |                |                |                |                |                |                |                            |               |  |         |              |         |            |          |           |       |
| 81.436.010.083  |                                |   |                    |                          |                  |  |   |      |              |               |         |                 |         |                 |         |                |                |                |                |                |                |                |                |                |                |                            |               |  |         |              |         |            |          |           |       |
| 81.436.010.090  |                                |   |                    |                          |                  |  |   |      |              |               |         |                 |         |                 |         |                |                |                |                |                |                |                |                |                |                |                            |               |  |         |              |         |            |          |           |       |
| 81.436.010.113  |                                |   |                    |                          |                  |  |   |      |              |               |         |                 |         |                 |         |                |                |                |                |                |                |                |                |                |                |                            |               |  |         |              |         |            |          |           |       |
| 81.436.010.115  |                                |   |                    |                          |                  |  |   |      |              |               |         |                 |         |                 |         |                |                |                |                |                |                |                |                |                |                |                            |               |  |         |              |         |            |          |           |       |
| 81.436.010.117  |                                |   |                    |                          |                  |  |   |      |              |               |         |                 |         |                 |         |                |                |                |                |                |                |                |                |                |                |                            |               |  |         |              |         |            |          |           |       |
| A3632290001<br>A3633280001  | MERCEDES-BENZ                  |   |                    |                          |                  |  |   |      |              |               |         |                 |         |                 |         |                |                |                |                |                |                |                |                |                |                |                            |               |  |         |              |         |            |          |           |       |
| V.I.5.000.786.901<br>V.I.5.000.819.517  | RENAULT                        |   |                    |                          |                  |  |   |      |              |               |         |                 |         |                 |         |                |                |                |                |                |                |                |                |                |                |                            |               |  |         |              |         |            |          |           |       |
| 6885533   | VOLVO                          |   |                    |                          |                  |  |   |      |              |               |         |                 |         |                 |         |                |                |                |                |                |                |                |                |                |                |                            |               |  |         |              |         |            |          |           |       |



| Code  | Section, Top View, Bottom View | Applications                              |                    |                          |                            |  |   |              |                |                            |          |               |           |               |           |         |            |            |            |           |            |            |         |             |         |             |         |             |         |          |         |          |         |
|---|--------------------------------|---|--------------------|--------------------------|----------------------------|--|---|--------------|----------------|----------------------------|----------|---------------|-----------|---------------|-----------|---------|------------|------------|------------|-----------|------------|------------|---------|-------------|---------|-------------|---------|-------------|---------|----------|---------|----------|---------|
| <b>FM18008.N</b>  |                                |   |                    |                          |                            |  |   |              |                |                            |          |               |           |               |           |         |            |            |            |           |            |            |         |             |         |             |         |             |         |          |         |          |         |
| <table border="1"> <tr><td>Competitor code</td></tr> <tr><td>Firestone<br/>1R1D 355 355<br/>W01-095-0207</td></tr> <tr><td>ContiTech<br/>662 N</td></tr> <tr><td>VIBRACOUSTIC<br/>V 1 E 32</td></tr> <tr><td>GOODYEAR<br/>9007</td></tr> </table> | Competitor code                | Firestone<br>1R1D 355 355<br>W01-095-0207 | ContiTech<br>662 N | VIBRACOUSTIC<br>V 1 E 32 | GOODYEAR<br>9007           |  | <table border="1"> <thead> <tr> <th>Code</th> <th>Manufacturer</th> </tr> </thead> <tbody> <tr><td>02.200.24.60.0</td><td>BPW</td></tr> <tr><td>81.43601.0018</td><td>MAN</td></tr> <tr><td>81.43601.0051</td><td>MAN</td></tr> <tr><td>750 209</td><td>Schmitz</td></tr> <tr><td>100110 200</td><td>Büssing</td></tr> <tr><td>100112251</td><td>Büssing</td></tr> <tr><td>1001 10200</td><td>Neoplan</td></tr> <tr><td>1001 12 251</td><td>Neoplan</td></tr> <tr><td>AA10-01-002</td><td>Neoplan</td></tr> <tr><td>AA10-21-300</td><td>Neoplan</td></tr> <tr><td>11016348</td><td>Neoplan</td></tr> <tr><td>0578 361</td><td>VDL BUS</td></tr> </tbody> </table> | Code         | Manufacturer   | 02.200.24.60.0             | BPW      | 81.43601.0018 | MAN       | 81.43601.0051 | MAN       | 750 209 | Schmitz    | 100110 200 | Büssing    | 100112251 | Büssing    | 1001 10200 | Neoplan | 1001 12 251 | Neoplan | AA10-01-002 | Neoplan | AA10-21-300 | Neoplan | 11016348 | Neoplan | 0578 361 | VDL BUS |
| Competitor code   |                                |   |                    |                          |                            |  |   |              |                |                            |          |               |           |               |           |         |            |            |            |           |            |            |         |             |         |             |         |             |         |          |         |          |         |
| Firestone<br>1R1D 355 355<br>W01-095-0207   |                                |   |                    |                          |                            |  |   |              |                |                            |          |               |           |               |           |         |            |            |            |           |            |            |         |             |         |             |         |             |         |          |         |          |         |
| ContiTech<br>662 N  |                                |   |                    |                          |                            |  |   |              |                |                            |          |               |           |               |           |         |            |            |            |           |            |            |         |             |         |             |         |             |         |          |         |          |         |
| VIBRACOUSTIC<br>V 1 E 32  |                                |   |                    |                          |                            |  |   |              |                |                            |          |               |           |               |           |         |            |            |            |           |            |            |         |             |         |             |         |             |         |          |         |          |         |
| GOODYEAR<br>9007  |                                |   |                    |                          |                            |  |   |              |                |                            |          |               |           |               |           |         |            |            |            |           |            |            |         |             |         |             |         |             |         |          |         |          |         |
| Code  | Manufacturer                   |   |                    |                          |                            |  |   |              |                |                            |          |               |           |               |           |         |            |            |            |           |            |            |         |             |         |             |         |             |         |          |         |          |         |
| 02.200.24.60.0  | BPW                            |   |                    |                          |                            |  |   |              |                |                            |          |               |           |               |           |         |            |            |            |           |            |            |         |             |         |             |         |             |         |          |         |          |         |
| 81.43601.0018   | MAN                            |   |                    |                          |                            |  |   |              |                |                            |          |               |           |               |           |         |            |            |            |           |            |            |         |             |         |             |         |             |         |          |         |          |         |
| 81.43601.0051   | MAN                            |   |                    |                          |                            |  |   |              |                |                            |          |               |           |               |           |         |            |            |            |           |            |            |         |             |         |             |         |             |         |          |         |          |         |
| 750 209   | Schmitz                        |   |                    |                          |                            |  |   |              |                |                            |          |               |           |               |           |         |            |            |            |           |            |            |         |             |         |             |         |             |         |          |         |          |         |
| 100110 200  | Büssing                        |   |                    |                          |                            |  |   |              |                |                            |          |               |           |               |           |         |            |            |            |           |            |            |         |             |         |             |         |             |         |          |         |          |         |
| 100112251   | Büssing                        |   |                    |                          |                            |  |   |              |                |                            |          |               |           |               |           |         |            |            |            |           |            |            |         |             |         |             |         |             |         |          |         |          |         |
| 1001 10200  | Neoplan                        |   |                    |                          |                            |  |   |              |                |                            |          |               |           |               |           |         |            |            |            |           |            |            |         |             |         |             |         |             |         |          |         |          |         |
| 1001 12 251   | Neoplan                        |   |                    |                          |                            |  |   |              |                |                            |          |               |           |               |           |         |            |            |            |           |            |            |         |             |         |             |         |             |         |          |         |          |         |
| AA10-01-002   | Neoplan                        |   |                    |                          |                            |  |   |              |                |                            |          |               |           |               |           |         |            |            |            |           |            |            |         |             |         |             |         |             |         |          |         |          |         |
| AA10-21-300   | Neoplan                        |   |                    |                          |                            |  |   |              |                |                            |          |               |           |               |           |         |            |            |            |           |            |            |         |             |         |             |         |             |         |          |         |          |         |
| 11016348  | Neoplan                        |   |                    |                          |                            |  |   |              |                |                            |          |               |           |               |           |         |            |            |            |           |            |            |         |             |         |             |         |             |         |          |         |          |         |
| 0578 361  | VDL BUS                        |   |                    |                          |                            |  |   |              |                |                            |          |               |           |               |           |         |            |            |            |           |            |            |         |             |         |             |         |             |         |          |         |          |         |
| <b>FM18009.N</b>  |                                |   |                    |                          |                            |  |   |              |                |                            |          |               |           |               |           |         |            |            |            |           |            |            |         |             |         |             |         |             |         |          |         |          |         |
| <table border="1"> <tr><td>Competitor code</td></tr> <tr><td>Firestone<br/>W01-095-0197</td></tr> <tr><td>ContiTech<br/>782 N</td></tr> <tr><td>GOODYEAR<br/>9013</td></tr> </table>  | Competitor code                | Firestone<br>W01-095-0197                 | ContiTech<br>782 N | GOODYEAR<br>9013         |                            | <table border="1"> <thead> <tr> <th>Code</th> <th>Manufacturer</th> </tr> </thead> <tbody> <tr><td>A 382.327.7201</td><td>EVO BUS<br/>(MERCEDES BENZ)</td></tr> <tr><td>8188539</td><td>IVECO</td></tr> <tr><td>500055041</td><td>IVECO</td></tr> <tr><td>500301452</td><td>PEGASO</td></tr> <tr><td>5000954176</td><td>IRIS BUS</td></tr> <tr><td>5000787632</td><td>IRIS BUS</td></tr> <tr><td>5000869179</td><td>IRIS BUS</td></tr> </tbody> </table> | Code  | Manufacturer | A 382.327.7201 | EVO BUS<br>(MERCEDES BENZ) | 8188539  | IVECO         | 500055041 | IVECO         | 500301452 | PEGASO  | 5000954176 | IRIS BUS   | 5000787632 | IRIS BUS  | 5000869179 | IRIS BUS   |         |             |         |             |         |             |         |          |         |          |         |
| Competitor code   |                                |   |                    |                          |                            |  |   |              |                |                            |          |               |           |               |           |         |            |            |            |           |            |            |         |             |         |             |         |             |         |          |         |          |         |
| Firestone<br>W01-095-0197   |                                |   |                    |                          |                            |  |   |              |                |                            |          |               |           |               |           |         |            |            |            |           |            |            |         |             |         |             |         |             |         |          |         |          |         |
| ContiTech<br>782 N  |                                |   |                    |                          |                            |  |   |              |                |                            |          |               |           |               |           |         |            |            |            |           |            |            |         |             |         |             |         |             |         |          |         |          |         |
| GOODYEAR<br>9013  |                                |   |                    |                          |                            |  |   |              |                |                            |          |               |           |               |           |         |            |            |            |           |            |            |         |             |         |             |         |             |         |          |         |          |         |
| Code  | Manufacturer                   |   |                    |                          |                            |  |   |              |                |                            |          |               |           |               |           |         |            |            |            |           |            |            |         |             |         |             |         |             |         |          |         |          |         |
| A 382.327.7201  | EVO BUS<br>(MERCEDES BENZ)     |   |                    |                          |                            |  |   |              |                |                            |          |               |           |               |           |         |            |            |            |           |            |            |         |             |         |             |         |             |         |          |         |          |         |
| 8188539   | IVECO                          |   |                    |                          |                            |  |   |              |                |                            |          |               |           |               |           |         |            |            |            |           |            |            |         |             |         |             |         |             |         |          |         |          |         |
| 500055041   | IVECO                          |   |                    |                          |                            |  |   |              |                |                            |          |               |           |               |           |         |            |            |            |           |            |            |         |             |         |             |         |             |         |          |         |          |         |
| 500301452   | PEGASO                         |   |                    |                          |                            |  |   |              |                |                            |          |               |           |               |           |         |            |            |            |           |            |            |         |             |         |             |         |             |         |          |         |          |         |
| 5000954176  | IRIS BUS                       |   |                    |                          |                            |  |   |              |                |                            |          |               |           |               |           |         |            |            |            |           |            |            |         |             |         |             |         |             |         |          |         |          |         |
| 5000787632  | IRIS BUS                       |   |                    |                          |                            |  |   |              |                |                            |          |               |           |               |           |         |            |            |            |           |            |            |         |             |         |             |         |             |         |          |         |          |         |
| 5000869179  | IRIS BUS                       |   |                    |                          |                            |  |   |              |                |                            |          |               |           |               |           |         |            |            |            |           |            |            |         |             |         |             |         |             |         |          |         |          |         |
| <b>FM18012.N</b>  |                                |   |                    |                          |                            |  |   |              |                |                            |          |               |           |               |           |         |            |            |            |           |            |            |         |             |         |             |         |             |         |          |         |          |         |
| <table border="1"> <tr><td>Competitor code</td></tr> <tr><td>Firestone</td></tr> <tr><td>ContiTech<br/>702 N</td></tr> <tr><td>GOODYEAR<br/>9011</td></tr> <tr><td>VIBRACOUSTIC<br/>V 1 E 26 A</td></tr> </table>                                 | Competitor code                | Firestone                                 | ContiTech<br>702 N | GOODYEAR<br>9011         | VIBRACOUSTIC<br>V 1 E 26 A |  | <table border="1"> <thead> <tr> <th>Code</th> <th>Manufacturer</th> </tr> </thead> <tbody> <tr><td>0501 323 798</td><td>ZF Sachs</td></tr> <tr><td>B 234908</td><td>BOVA</td></tr> </tbody> </table>  | Code         | Manufacturer   | 0501 323 798               | ZF Sachs | B 234908      | BOVA      |               |           |         |            |            |            |           |            |            |         |             |         |             |         |             |         |          |         |          |         |
| Competitor code   |                                |   |                    |                          |                            |  |   |              |                |                            |          |               |           |               |           |         |            |            |            |           |            |            |         |             |         |             |         |             |         |          |         |          |         |
| Firestone   |                                |   |                    |                          |                            |  |   |              |                |                            |          |               |           |               |           |         |            |            |            |           |            |            |         |             |         |             |         |             |         |          |         |          |         |
| ContiTech<br>702 N  |                                |   |                    |                          |                            |  |   |              |                |                            |          |               |           |               |           |         |            |            |            |           |            |            |         |             |         |             |         |             |         |          |         |          |         |
| GOODYEAR<br>9011  |                                |   |                    |                          |                            |  |   |              |                |                            |          |               |           |               |           |         |            |            |            |           |            |            |         |             |         |             |         |             |         |          |         |          |         |
| VIBRACOUSTIC<br>V 1 E 26 A  |                                |   |                    |                          |                            |  |   |              |                |                            |          |               |           |               |           |         |            |            |            |           |            |            |         |             |         |             |         |             |         |          |         |          |         |
| Code  | Manufacturer                   |   |                    |                          |                            |  |   |              |                |                            |          |               |           |               |           |         |            |            |            |           |            |            |         |             |         |             |         |             |         |          |         |          |         |
| 0501 323 798  | ZF Sachs                       |   |                    |                          |                            |  |   |              |                |                            |          |               |           |               |           |         |            |            |            |           |            |            |         |             |         |             |         |             |         |          |         |          |         |
| B 234908  | BOVA                           |   |                    |                          |                            |  |   |              |                |                            |          |               |           |               |           |         |            |            |            |           |            |            |         |             |         |             |         |             |         |          |         |          |         |



| Code   | Section, Top View, Bottom View | Applications                             |                    |                  |  |  |      |              |          |                   |               |         |               |          |               |          |            |            |            |           |  |         |  |        |
|--|--------------------------------|--|--------------------|------------------|--|--|------|--------------|----------|-------------------|---------------|---------|---------------|----------|---------------|----------|------------|------------|------------|-----------|--|---------|--|--------|
| <b>FM18023.N</b>   |                                |  |                    |                  |  |  |      |              |          |                   |               |         |               |          |               |          |            |            |            |           |  |         |  |        |
| <table border="1"> <tr><td>Competitor code</td></tr> <tr><td>Firestone<br/>W01-095-0204</td></tr> <tr><td>ContiTech<br/>769 N</td></tr> <tr><td>GOODYEAR<br/>8053</td></tr> </table>                 | Competitor code                | Firestone<br>W01-095-0204                | ContiTech<br>769 N | GOODYEAR<br>8053 |  | <table border="1"> <thead> <tr> <th>Code</th> <th>Manufacturer</th> </tr> </thead> <tbody> <tr><td>96708574</td><td>Daewoo</td></tr> <tr><td>5 000 805 284</td><td>Heuliez</td></tr> <tr><td>5.000.786.640</td><td>IRIS BUS</td></tr> <tr><td>5.000.805.284</td><td>IRIS BUS</td></tr> <tr><td>624319-860</td><td>VAN HOOL</td></tr> <tr><td>229000003C</td><td>King Long</td></tr> <tr><td></td><td>Hyundai</td></tr> <tr><td></td><td>SCANIA</td></tr> </tbody> </table> | Code | Manufacturer | 96708574 | Daewoo            | 5 000 805 284 | Heuliez | 5.000.786.640 | IRIS BUS | 5.000.805.284 | IRIS BUS | 624319-860 | VAN HOOL   | 229000003C | King Long |  | Hyundai |  | SCANIA |
| Competitor code  |                                |  |                    |                  |  |  |      |              |          |                   |               |         |               |          |               |          |            |            |            |           |  |         |  |        |
| Firestone<br>W01-095-0204  |                                |  |                    |                  |  |  |      |              |          |                   |               |         |               |          |               |          |            |            |            |           |  |         |  |        |
| ContiTech<br>769 N   |                                |  |                    |                  |  |  |      |              |          |                   |               |         |               |          |               |          |            |            |            |           |  |         |  |        |
| GOODYEAR<br>8053   |                                |  |                    |                  |  |  |      |              |          |                   |               |         |               |          |               |          |            |            |            |           |  |         |  |        |
| Code   | Manufacturer                   |  |                    |                  |  |  |      |              |          |                   |               |         |               |          |               |          |            |            |            |           |  |         |  |        |
| 96708574   | Daewoo                         |  |                    |                  |  |  |      |              |          |                   |               |         |               |          |               |          |            |            |            |           |  |         |  |        |
| 5 000 805 284  | Heuliez                        |  |                    |                  |  |  |      |              |          |                   |               |         |               |          |               |          |            |            |            |           |  |         |  |        |
| 5.000.786.640  | IRIS BUS                       |  |                    |                  |  |  |      |              |          |                   |               |         |               |          |               |          |            |            |            |           |  |         |  |        |
| 5.000.805.284  | IRIS BUS                       |  |                    |                  |  |  |      |              |          |                   |               |         |               |          |               |          |            |            |            |           |  |         |  |        |
| 624319-860   | VAN HOOL                       |  |                    |                  |  |  |      |              |          |                   |               |         |               |          |               |          |            |            |            |           |  |         |  |        |
| 229000003C   | King Long                      |  |                    |                  |  |  |      |              |          |                   |               |         |               |          |               |          |            |            |            |           |  |         |  |        |
|  | Hyundai                        |  |                    |                  |  |  |      |              |          |                   |               |         |               |          |               |          |            |            |            |           |  |         |  |        |
|  | SCANIA                         |  |                    |                  |  |  |      |              |          |                   |               |         |               |          |               |          |            |            |            |           |  |         |  |        |
| <b>FM18029.N</b>   |                                |  |                    |                  |  |  |      |              |          |                   |               |         |               |          |               |          |            |            |            |           |  |         |  |        |
| <table border="1"> <tr><td>Competitor code</td></tr> <tr><td>Firestone<br/>1R1A460-290<br/>W01-095-0063</td></tr> <tr><td>ContiTech<br/>945 N</td></tr> <tr><td>GOODYEAR<br/>9014</td></tr> </table> | Competitor code                | Firestone<br>1R1A460-290<br>W01-095-0063 | ContiTech<br>945 N | GOODYEAR<br>9014 |  | <table border="1"> <thead> <tr> <th>Code</th> <th>Manufacturer</th> </tr> </thead> <tbody> <tr><td>178741</td><td>BREDAMENARINI BUS</td></tr> <tr><td>4716989</td><td>IVECO</td></tr> <tr><td>4716989</td><td>IVECO</td></tr> <tr><td>500055250</td><td>IVECO</td></tr> <tr><td></td><td>PEGASO BUS</td></tr> <tr><td></td><td>SCANIA</td></tr> </tbody> </table>  | Code | Manufacturer | 178741   | BREDAMENARINI BUS | 4716989       | IVECO   | 4716989       | IVECO    | 500055250     | IVECO    |            | PEGASO BUS |            | SCANIA    |  |         |  |        |
| Competitor code  |                                |  |                    |                  |  |  |      |              |          |                   |               |         |               |          |               |          |            |            |            |           |  |         |  |        |
| Firestone<br>1R1A460-290<br>W01-095-0063   |                                |  |                    |                  |  |  |      |              |          |                   |               |         |               |          |               |          |            |            |            |           |  |         |  |        |
| ContiTech<br>945 N   |                                |  |                    |                  |  |  |      |              |          |                   |               |         |               |          |               |          |            |            |            |           |  |         |  |        |
| GOODYEAR<br>9014   |                                |  |                    |                  |  |  |      |              |          |                   |               |         |               |          |               |          |            |            |            |           |  |         |  |        |
| Code   | Manufacturer                   |  |                    |                  |  |  |      |              |          |                   |               |         |               |          |               |          |            |            |            |           |  |         |  |        |
| 178741   | BREDAMENARINI BUS              |  |                    |                  |  |  |      |              |          |                   |               |         |               |          |               |          |            |            |            |           |  |         |  |        |
| 4716989  | IVECO                          |  |                    |                  |  |  |      |              |          |                   |               |         |               |          |               |          |            |            |            |           |  |         |  |        |
| 4716989  | IVECO                          |  |                    |                  |  |  |      |              |          |                   |               |         |               |          |               |          |            |            |            |           |  |         |  |        |
| 500055250  | IVECO                          |  |                    |                  |  |  |      |              |          |                   |               |         |               |          |               |          |            |            |            |           |  |         |  |        |
|  | PEGASO BUS                     |  |                    |                  |  |  |      |              |          |                   |               |         |               |          |               |          |            |            |            |           |  |         |  |        |
|  | SCANIA                         |  |                    |                  |  |  |      |              |          |                   |               |         |               |          |               |          |            |            |            |           |  |         |  |        |

| Code  | Section, Top View, Bottom View | Applications                                   |                     |                  |                              |  |  |  |      |              |               |        |               |         |                            |     |  |         |               |                   |               |         |             |        |  |            |               |     |        |          |   |               |                            |         |  |          |                               |       |
|---|--------------------------------|--|---------------------|------------------|------------------------------|--|--|--|------|--------------|---------------|--------|---------------|---------|----------------------------|-----|--|---------|---------------|-------------------|---------------|---------|-------------|--------|--|------------|---------------|-----|--------|----------|---|---------------|----------------------------|---------|--|----------|-------------------------------|-------|
| <b>FM18030.N</b>  |                                |  |                     |                  |                              |  |  |  |      |              |               |        |               |         |                            |     |  |         |               |                   |               |         |             |        |  |            |               |     |        |          |   |               |                            |         |  |          |                               |       |
| <table border="1"> <tr> <td>Competitor code</td> </tr> <tr> <td>Firestone<br/>1R1A 390-295<br/>W01-095-0118/4002</td> </tr> <tr> <td>ContiTech<br/>644 N</td> </tr> <tr> <td>GOODYEAR<br/>8017</td> </tr> <tr> <td>VIBRAACOUSTIC<br/>V 1 E 21</td> </tr> </table> | Competitor code                | Firestone<br>1R1A 390-295<br>W01-095-0118/4002 | ContiTech<br>644 N  | GOODYEAR<br>8017 | VIBRAACOUSTIC<br>V 1 E 21    |  | <table border="1"> <thead> <tr> <th>Code</th> <th>Manufacturer</th> </tr> </thead> <tbody> <tr> <td>02.2002.4400</td> <td>B.P.W.</td> </tr> <tr> <td>536905265/6</td> <td>BUSSING</td> </tr> <tr> <td>644425<br/>689677<br/>696229</td> <td>DAF</td> </tr> <tr> <td>307.328.0001<br/>327.328.0001<br/>4.771.143.000<br/>4.771.170.000<br/>A.000.327.0101</td> <td>EVO BUS</td> </tr> <tr> <td>546.905.134</td> <td>HANOMAG-HENSCHHEL</td> </tr> <tr> <td>0.305G 10303</td> <td>HEULIEZ</td> </tr> <tr> <td>536 905 265</td> <td>IVECO</td> </tr> <tr> <td>4771110000<br/>4771143000<br/>4771170000<br/>4771359000<br/>4771441000</td> <td>KÄSSBOHRER</td> </tr> <tr> <td>81.43601.0017</td> <td>MAN</td> </tr> <tr> <td>199196</td> <td>MENARINI</td> </tr> <tr> <td>A0003270101<br/>A3073270001<br/>A3073270101<br/>A3073280001<br/>A3643277001</td> <td>MERCEDES-BENZ</td> </tr> <tr> <td>1001.103.00<br/>1001.122.54</td> <td>NEOPLAN</td> </tr> <tr> <td>624319-420<br/>624319-600<br/>624319-610<br/>624319-630</td> <td>VAN HOOL</td> </tr> <tr> <td>1134445<br/>1199873<br/>1199893</td> <td>VOLVO</td> </tr> </tbody> </table> |  | Code | Manufacturer | 02.2002.4400  | B.P.W. | 536905265/6   | BUSSING | 644425<br>689677<br>696229 | DAF | 307.328.0001<br>327.328.0001<br>4.771.143.000<br>4.771.170.000<br>A.000.327.0101 | EVO BUS | 546.905.134   | HANOMAG-HENSCHHEL | 0.305G 10303  | HEULIEZ | 536 905 265 | IVECO  | 4771110000<br>4771143000<br>4771170000<br>4771359000<br>4771441000 | KÄSSBOHRER | 81.43601.0017 | MAN | 199196 | MENARINI | A0003270101<br>A3073270001<br>A3073270101<br>A3073280001<br>A3643277001 | MERCEDES-BENZ | 1001.103.00<br>1001.122.54 | NEOPLAN | 624319-420<br>624319-600<br>624319-610<br>624319-630 | VAN HOOL | 1134445<br>1199873<br>1199893 | VOLVO |
| Competitor code   |                                |  |                     |                  |                              |  |  |  |      |              |               |        |               |         |                            |     |  |         |               |                   |               |         |             |        |  |            |               |     |        |          |   |               |                            |         |  |          |                               |       |
| Firestone<br>1R1A 390-295<br>W01-095-0118/4002  |                                |  |                     |                  |                              |  |  |  |      |              |               |        |               |         |                            |     |  |         |               |                   |               |         |             |        |  |            |               |     |        |          |   |               |                            |         |  |          |                               |       |
| ContiTech<br>644 N  |                                |  |                     |                  |                              |  |  |  |      |              |               |        |               |         |                            |     |  |         |               |                   |               |         |             |        |  |            |               |     |        |          |   |               |                            |         |  |          |                               |       |
| GOODYEAR<br>8017  |                                |  |                     |                  |                              |  |  |  |      |              |               |        |               |         |                            |     |  |         |               |                   |               |         |             |        |  |            |               |     |        |          |   |               |                            |         |  |          |                               |       |
| VIBRAACOUSTIC<br>V 1 E 21   |                                |  |                     |                  |                              |  |  |  |      |              |               |        |               |         |                            |     |  |         |               |                   |               |         |             |        |  |            |               |     |        |          |   |               |                            |         |  |          |                               |       |
| Code  | Manufacturer                   |  |                     |                  |                              |  |  |  |      |              |               |        |               |         |                            |     |  |         |               |                   |               |         |             |        |  |            |               |     |        |          |   |               |                            |         |  |          |                               |       |
| 02.2002.4400  | B.P.W.                         |  |                     |                  |                              |  |  |  |      |              |               |        |               |         |                            |     |  |         |               |                   |               |         |             |        |  |            |               |     |        |          |   |               |                            |         |  |          |                               |       |
| 536905265/6   | BUSSING                        |  |                     |                  |                              |  |  |  |      |              |               |        |               |         |                            |     |  |         |               |                   |               |         |             |        |  |            |               |     |        |          |   |               |                            |         |  |          |                               |       |
| 644425<br>689677<br>696229  | DAF                            |  |                     |                  |                              |  |  |  |      |              |               |        |               |         |                            |     |  |         |               |                   |               |         |             |        |  |            |               |     |        |          |   |               |                            |         |  |          |                               |       |
| 307.328.0001<br>327.328.0001<br>4.771.143.000<br>4.771.170.000<br>A.000.327.0101  | EVO BUS                        |  |                     |                  |                              |  |  |  |      |              |               |        |               |         |                            |     |  |         |               |                   |               |         |             |        |  |            |               |     |        |          |   |               |                            |         |  |          |                               |       |
| 546.905.134   | HANOMAG-HENSCHHEL              |  |                     |                  |                              |  |  |  |      |              |               |        |               |         |                            |     |  |         |               |                   |               |         |             |        |  |            |               |     |        |          |   |               |                            |         |  |          |                               |       |
| 0.305G 10303  | HEULIEZ                        |  |                     |                  |                              |  |  |  |      |              |               |        |               |         |                            |     |  |         |               |                   |               |         |             |        |  |            |               |     |        |          |   |               |                            |         |  |          |                               |       |
| 536 905 265   | IVECO                          |  |                     |                  |                              |  |  |  |      |              |               |        |               |         |                            |     |  |         |               |                   |               |         |             |        |  |            |               |     |        |          |   |               |                            |         |  |          |                               |       |
| 4771110000<br>4771143000<br>4771170000<br>4771359000<br>4771441000  | KÄSSBOHRER                     |  |                     |                  |                              |  |  |  |      |              |               |        |               |         |                            |     |  |         |               |                   |               |         |             |        |  |            |               |     |        |          |   |               |                            |         |  |          |                               |       |
| 81.43601.0017   | MAN                            |  |                     |                  |                              |  |  |  |      |              |               |        |               |         |                            |     |  |         |               |                   |               |         |             |        |  |            |               |     |        |          |   |               |                            |         |  |          |                               |       |
| 199196  | MENARINI                       |  |                     |                  |                              |  |  |  |      |              |               |        |               |         |                            |     |  |         |               |                   |               |         |             |        |  |            |               |     |        |          |   |               |                            |         |  |          |                               |       |
| A0003270101<br>A3073270001<br>A3073270101<br>A3073280001<br>A3643277001   | MERCEDES-BENZ                  |  |                     |                  |                              |  |  |  |      |              |               |        |               |         |                            |     |  |         |               |                   |               |         |             |        |  |            |               |     |        |          |   |               |                            |         |  |          |                               |       |
| 1001.103.00<br>1001.122.54  | NEOPLAN                        |  |                     |                  |                              |  |  |  |      |              |               |        |               |         |                            |     |  |         |               |                   |               |         |             |        |  |            |               |     |        |          |   |               |                            |         |  |          |                               |       |
| 624319-420<br>624319-600<br>624319-610<br>624319-630  | VAN HOOL                       |  |                     |                  |                              |  |  |  |      |              |               |        |               |         |                            |     |  |         |               |                   |               |         |             |        |  |            |               |     |        |          |   |               |                            |         |  |          |                               |       |
| 1134445<br>1199873<br>1199893   | VOLVO                          |  |                     |                  |                              |  |  |  |      |              |               |        |               |         |                            |     |  |         |               |                   |               |         |             |        |  |            |               |     |        |          |   |               |                            |         |  |          |                               |       |
| <b>FM18033.N</b>  |                                |  |                     |                  |                              |  |  |  |      |              |               |        |               |         |                            |     |  |         |               |                   |               |         |             |        |  |            |               |     |        |          |   |               |                            |         |  |          |                               |       |
| <table border="1"> <tr> <td>Competitor code</td> </tr> <tr> <td>Firestone<br/>2R2A 460-295<br/>W01-095-0555</td> </tr> <tr> <td>ContiTech<br/>916 N1</td> </tr> <tr> <td>GOODYEAR<br/>9015</td> </tr> <tr> <td>VIBRAACOUSTIC<br/>V 1 F 21C-5</td> </tr> </table>  | Competitor code                | Firestone<br>2R2A 460-295<br>W01-095-0555      | ContiTech<br>916 N1 | GOODYEAR<br>9015 | VIBRAACOUSTIC<br>V 1 F 21C-5 |  | <table border="1"> <thead> <tr> <th>Code</th> <th>Manufacturer</th> </tr> </thead> <tbody> <tr> <td>81.43601.0095</td> <td>MAN</td> </tr> <tr> <td>81.43601.0097</td> <td>MAN</td> </tr> <tr> <td>81.43601.0100</td> <td>MAN</td> </tr> <tr> <td>81.43601.0102</td> <td>MAN</td> </tr> <tr> <td>81.43601.0105</td> <td>MAN</td> </tr> <tr> <td>81.43601.0126</td> <td>MAN</td> </tr> <tr> <td>L5820005</td> <td>OPTARE</td> </tr> </tbody> </table>  |  | Code | Manufacturer | 81.43601.0095 | MAN    | 81.43601.0097 | MAN     | 81.43601.0100              | MAN | 81.43601.0102  | MAN     | 81.43601.0105 | MAN               | 81.43601.0126 | MAN     | L5820005    | OPTARE |  |            |               |     |        |          |   |               |                            |         |  |          |                               |       |
| Competitor code   |                                |  |                     |                  |                              |  |  |  |      |              |               |        |               |         |                            |     |  |         |               |                   |               |         |             |        |  |            |               |     |        |          |   |               |                            |         |  |          |                               |       |
| Firestone<br>2R2A 460-295<br>W01-095-0555   |                                |  |                     |                  |                              |  |  |  |      |              |               |        |               |         |                            |     |  |         |               |                   |               |         |             |        |  |            |               |     |        |          |   |               |                            |         |  |          |                               |       |
| ContiTech<br>916 N1   |                                |  |                     |                  |                              |  |  |  |      |              |               |        |               |         |                            |     |  |         |               |                   |               |         |             |        |  |            |               |     |        |          |   |               |                            |         |  |          |                               |       |
| GOODYEAR<br>9015  |                                |  |                     |                  |                              |  |  |  |      |              |               |        |               |         |                            |     |  |         |               |                   |               |         |             |        |  |            |               |     |        |          |   |               |                            |         |  |          |                               |       |
| VIBRAACOUSTIC<br>V 1 F 21C-5  |                                |  |                     |                  |                              |  |  |  |      |              |               |        |               |         |                            |     |  |         |               |                   |               |         |             |        |  |            |               |     |        |          |   |               |                            |         |  |          |                               |       |
| Code  | Manufacturer                   |  |                     |                  |                              |  |  |  |      |              |               |        |               |         |                            |     |  |         |               |                   |               |         |             |        |  |            |               |     |        |          |   |               |                            |         |  |          |                               |       |
| 81.43601.0095   | MAN                            |  |                     |                  |                              |  |  |  |      |              |               |        |               |         |                            |     |  |         |               |                   |               |         |             |        |  |            |               |     |        |          |   |               |                            |         |  |          |                               |       |
| 81.43601.0097   | MAN                            |  |                     |                  |                              |  |  |  |      |              |               |        |               |         |                            |     |  |         |               |                   |               |         |             |        |  |            |               |     |        |          |   |               |                            |         |  |          |                               |       |
| 81.43601.0100   | MAN                            |  |                     |                  |                              |  |  |  |      |              |               |        |               |         |                            |     |  |         |               |                   |               |         |             |        |  |            |               |     |        |          |   |               |                            |         |  |          |                               |       |
| 81.43601.0102   | MAN                            |  |                     |                  |                              |  |  |  |      |              |               |        |               |         |                            |     |  |         |               |                   |               |         |             |        |  |            |               |     |        |          |   |               |                            |         |  |          |                               |       |
| 81.43601.0105   | MAN                            |  |                     |                  |                              |  |  |  |      |              |               |        |               |         |                            |     |  |         |               |                   |               |         |             |        |  |            |               |     |        |          |   |               |                            |         |  |          |                               |       |
| 81.43601.0126   | MAN                            |  |                     |                  |                              |  |  |  |      |              |               |        |               |         |                            |     |  |         |               |                   |               |         |             |        |  |            |               |     |        |          |   |               |                            |         |  |          |                               |       |
| L5820005  | OPTARE                         |  |                     |                  |                              |  |  |  |      |              |               |        |               |         |                            |     |  |         |               |                   |               |         |             |        |  |            |               |     |        |          |   |               |                            |         |  |          |                               |       |



| Code   | Section, Top View, Bottom View | Applications                        |                            |               |                        |   |   |      |              |               |                |               |                |               |               |               |               |               |               |               |               |               |               |                |
|--|--------------------------------|-------------------------------------|----------------------------|---------------|------------------------|---|---|------|--------------|---------------|----------------|---------------|----------------|---------------|---------------|---------------|---------------|---------------|---------------|---------------|---------------|---------------|---------------|----------------|
| <b>FM18033.N</b>   |                                |                                     |                            |               |                        |   |   |      |              |               |                |               |                |               |               |               |               |               |               |               |               |               |               |                |
| <table border="1"> <tr><td>Competitor code</td></tr> <tr><td>Firestone</td></tr> <tr><td>ContiTech 916 N4</td></tr> <tr><td>GOODYEAR</td></tr> </table>  | Competitor code                | Firestone                           | ContiTech 916 N4           | GOODYEAR      |                        | <table border="1"> <thead> <tr> <th>Code</th> <th>Manufacturer</th> </tr> </thead> <tbody> <tr> <td>36.43601.0009</td> <td>MAN</td> </tr> </tbody> </table> |   | Code | Manufacturer | 36.43601.0009 | MAN            |               |                |               |               |               |               |               |               |               |               |               |               |                |
| Competitor code  |                                |                                     |                            |               |                        |   |   |      |              |               |                |               |                |               |               |               |               |               |               |               |               |               |               |                |
| Firestone  |                                |                                     |                            |               |                        |   |   |      |              |               |                |               |                |               |               |               |               |               |               |               |               |               |               |                |
| ContiTech 916 N4   |                                |                                     |                            |               |                        |   |   |      |              |               |                |               |                |               |               |               |               |               |               |               |               |               |               |                |
| GOODYEAR   |                                |                                     |                            |               |                        |   |   |      |              |               |                |               |                |               |               |               |               |               |               |               |               |               |               |                |
| Code   | Manufacturer                   |                                     |                            |               |                        |   |   |      |              |               |                |               |                |               |               |               |               |               |               |               |               |               |               |                |
| 36.43601.0009  | MAN                            |                                     |                            |               |                        |   |   |      |              |               |                |               |                |               |               |               |               |               |               |               |               |               |               |                |
| <b>FM18036.N</b>   |                                |                                     |                            |               |                        |   |   |      |              |               |                |               |                |               |               |               |               |               |               |               |               |               |               |                |
| <table border="1"> <tr><td>Competitor code</td></tr> <tr><td>Firestone 1R2A445-280 W01-095-0429</td></tr> <tr><td>ContiTech 1885 N1; 1884 N1</td></tr> <tr><td>GOODYEAR 9003</td></tr> <tr><td>VIBRACOUSTIC V 1 F 20B</td></tr> </table> | Competitor code                | Firestone 1R2A445-280 W01-095-0429  | ContiTech 1885 N1; 1884 N1 | GOODYEAR 9003 | VIBRACOUSTIC V 1 F 20B |   | <table border="1"> <thead> <tr> <th>Code</th> <th>Manufacturer</th> </tr> </thead> <tbody> <tr><td>81.43601.0104</td><td rowspan="7">MAN</td></tr> <tr><td>81.43601.0109</td></tr> <tr><td>81.43601.0111</td></tr> <tr><td>81.43601.0120</td></tr> <tr><td>81.43601.0123</td></tr> <tr><td>81.43601.0125</td></tr> <tr><td>81.43601.0140</td></tr> <tr><td>81.43601.0150</td></tr> <tr><td>98478799</td><td>IVECO</td></tr> <tr><td>544008-020</td><td rowspan="2">MERCEDES-BENZ</td></tr> <tr><td>643008-020</td></tr> </tbody> </table>                 |      | Code         | Manufacturer  | 81.43601.0104  | MAN           | 81.43601.0109  | 81.43601.0111 | 81.43601.0120 | 81.43601.0123 | 81.43601.0125 | 81.43601.0140 | 81.43601.0150 | 98478799      | IVECO         | 544008-020    | MERCEDES-BENZ | 643008-020     |
| Competitor code  |                                |                                     |                            |               |                        |   |   |      |              |               |                |               |                |               |               |               |               |               |               |               |               |               |               |                |
| Firestone 1R2A445-280 W01-095-0429   |                                |                                     |                            |               |                        |   |   |      |              |               |                |               |                |               |               |               |               |               |               |               |               |               |               |                |
| ContiTech 1885 N1; 1884 N1   |                                |                                     |                            |               |                        |   |   |      |              |               |                |               |                |               |               |               |               |               |               |               |               |               |               |                |
| GOODYEAR 9003  |                                |                                     |                            |               |                        |   |   |      |              |               |                |               |                |               |               |               |               |               |               |               |               |               |               |                |
| VIBRACOUSTIC V 1 F 20B   |                                |                                     |                            |               |                        |   |   |      |              |               |                |               |                |               |               |               |               |               |               |               |               |               |               |                |
| Code   | Manufacturer                   |                                     |                            |               |                        |   |   |      |              |               |                |               |                |               |               |               |               |               |               |               |               |               |               |                |
| 81.43601.0104  | MAN                            |                                     |                            |               |                        |   |   |      |              |               |                |               |                |               |               |               |               |               |               |               |               |               |               |                |
| 81.43601.0109  |                                |                                     |                            |               |                        |   |   |      |              |               |                |               |                |               |               |               |               |               |               |               |               |               |               |                |
| 81.43601.0111  |                                |                                     |                            |               |                        |   |   |      |              |               |                |               |                |               |               |               |               |               |               |               |               |               |               |                |
| 81.43601.0120  |                                |                                     |                            |               |                        |   |   |      |              |               |                |               |                |               |               |               |               |               |               |               |               |               |               |                |
| 81.43601.0123  |                                |                                     |                            |               |                        |   |   |      |              |               |                |               |                |               |               |               |               |               |               |               |               |               |               |                |
| 81.43601.0125  |                                |                                     |                            |               |                        |   |   |      |              |               |                |               |                |               |               |               |               |               |               |               |               |               |               |                |
| 81.43601.0140  |                                |                                     |                            |               |                        |   |   |      |              |               |                |               |                |               |               |               |               |               |               |               |               |               |               |                |
| 81.43601.0150  |                                |                                     |                            |               |                        |   |   |      |              |               |                |               |                |               |               |               |               |               |               |               |               |               |               |                |
| 98478799   | IVECO                          |                                     |                            |               |                        |   |   |      |              |               |                |               |                |               |               |               |               |               |               |               |               |               |               |                |
| 544008-020   | MERCEDES-BENZ                  |                                     |                            |               |                        |   |   |      |              |               |                |               |                |               |               |               |               |               |               |               |               |               |               |                |
| 643008-020   |                                |                                     |                            |               |                        |   |   |      |              |               |                |               |                |               |               |               |               |               |               |               |               |               |               |                |
| <b>FM18053.N</b>   |                                |                                     |                            |               |                        |   |   |      |              |               |                |               |                |               |               |               |               |               |               |               |               |               |               |                |
| <table border="1"> <tr><td>Competitor code</td></tr> <tr><td>Firestone 1R4R 465 260 W01-095-0435</td></tr> <tr><td>ContiTech 882 N1</td></tr> <tr><td>GOODYEAR 9048</td></tr> <tr><td>VIBRACOUSTIC V 1 F 16</td></tr> </table>           | Competitor code                | Firestone 1R4R 465 260 W01-095-0435 | ContiTech 882 N1           | GOODYEAR 9048 | VIBRACOUSTIC V 1 F 16  |   | <table border="1"> <thead> <tr> <th>Code</th> <th>Manufacturer</th> </tr> </thead> <tbody> <tr><td>A 658.328.0101</td><td rowspan="2">MERCEDES-BENZ</td></tr> <tr><td>A 699.328.0101</td></tr> <tr><td>81.43601.0065</td><td rowspan="9">MAN</td></tr> <tr><td>81.43601.0067</td></tr> <tr><td>81.43601.0070</td></tr> <tr><td>81.43601.0092</td></tr> <tr><td>81.43601.0099</td></tr> <tr><td>81.43601.0103</td></tr> <tr><td>81.43601.0121</td></tr> <tr><td>81.43601.0132</td></tr> <tr><td>D031115</td><td>BREDA MENARINI</td></tr> </tbody> </table> |      | Code         | Manufacturer  | A 658.328.0101 | MERCEDES-BENZ | A 699.328.0101 | 81.43601.0065 | MAN           | 81.43601.0067 | 81.43601.0070 | 81.43601.0092 | 81.43601.0099 | 81.43601.0103 | 81.43601.0121 | 81.43601.0132 | D031115       | BREDA MENARINI |
| Competitor code  |                                |                                     |                            |               |                        |   |   |      |              |               |                |               |                |               |               |               |               |               |               |               |               |               |               |                |
| Firestone 1R4R 465 260 W01-095-0435  |                                |                                     |                            |               |                        |   |   |      |              |               |                |               |                |               |               |               |               |               |               |               |               |               |               |                |
| ContiTech 882 N1   |                                |                                     |                            |               |                        |   |   |      |              |               |                |               |                |               |               |               |               |               |               |               |               |               |               |                |
| GOODYEAR 9048  |                                |                                     |                            |               |                        |   |   |      |              |               |                |               |                |               |               |               |               |               |               |               |               |               |               |                |
| VIBRACOUSTIC V 1 F 16  |                                |                                     |                            |               |                        |   |   |      |              |               |                |               |                |               |               |               |               |               |               |               |               |               |               |                |
| Code   | Manufacturer                   |                                     |                            |               |                        |   |   |      |              |               |                |               |                |               |               |               |               |               |               |               |               |               |               |                |
| A 658.328.0101   | MERCEDES-BENZ                  |                                     |                            |               |                        |   |   |      |              |               |                |               |                |               |               |               |               |               |               |               |               |               |               |                |
| A 699.328.0101   |                                |                                     |                            |               |                        |   |   |      |              |               |                |               |                |               |               |               |               |               |               |               |               |               |               |                |
| 81.43601.0065  | MAN                            |                                     |                            |               |                        |   |   |      |              |               |                |               |                |               |               |               |               |               |               |               |               |               |               |                |
| 81.43601.0067  |                                |                                     |                            |               |                        |   |   |      |              |               |                |               |                |               |               |               |               |               |               |               |               |               |               |                |
| 81.43601.0070  |                                |                                     |                            |               |                        |   |   |      |              |               |                |               |                |               |               |               |               |               |               |               |               |               |               |                |
| 81.43601.0092  |                                |                                     |                            |               |                        |   |   |      |              |               |                |               |                |               |               |               |               |               |               |               |               |               |               |                |
| 81.43601.0099  |                                |                                     |                            |               |                        |   |   |      |              |               |                |               |                |               |               |               |               |               |               |               |               |               |               |                |
| 81.43601.0103  |                                |                                     |                            |               |                        |   |   |      |              |               |                |               |                |               |               |               |               |               |               |               |               |               |               |                |
| 81.43601.0121  |                                |                                     |                            |               |                        |   |   |      |              |               |                |               |                |               |               |               |               |               |               |               |               |               |               |                |
| 81.43601.0132  |                                |                                     |                            |               |                        |   |   |      |              |               |                |               |                |               |               |               |               |               |               |               |               |               |               |                |
| D031115  |                                | BREDA MENARINI                      |                            |               |                        |   |   |      |              |               |                |               |                |               |               |               |               |               |               |               |               |               |               |                |

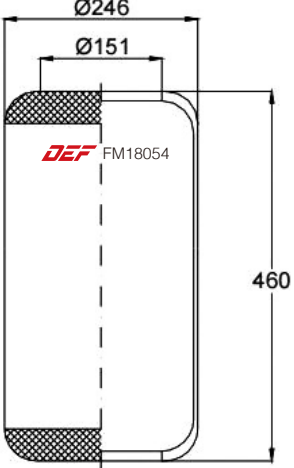

| Code  | Section, Top View, Bottom View | Applications |                     |                  |              |   |  |  |      |              |         |       |          |              |         |               |               |            |         |
|---|--------------------------------|--------------|---------------------|------------------|--------------|---|--|--|------|--------------|---------|-------|----------|--------------|---------|---------------|---------------|------------|---------|
| <b>FM18030.N</b>  |                                |              |                     |                  |              |   |  |  |      |              |         |       |          |              |         |               |               |            |         |
| <table border="1"> <tr><td>Competitor code</td></tr> <tr><td>Firestone</td></tr> <tr><td>ContiTech<br/>876 N1</td></tr> <tr><td>GOODYEAR<br/>8314</td></tr> <tr><td>VIBRACOUSTIC</td></tr> </table> | Competitor code                | Firestone    | ContiTech<br>876 N1 | GOODYEAR<br>8314 | VIBRACOUSTIC |  | <table border="1"> <thead> <tr> <th>Code</th> <th>Manufacturer</th> </tr> </thead> <tbody> <tr> <td>8139068</td> <td rowspan="2">IVECO</td> </tr> <tr> <td>41022620</td> </tr> <tr> <td>5.000296.816</td> <td rowspan="3">IRISBUS</td> </tr> <tr> <td>5.000.296.816</td> </tr> <tr> <td>5.000.296.827</td> </tr> <tr> <td>5000296816</td> <td>RENAULT</td> </tr> </tbody> </table> |  | Code | Manufacturer | 8139068 | IVECO | 41022620 | 5.000296.816 | IRISBUS | 5.000.296.816 | 5.000.296.827 | 5000296816 | RENAULT |
| Competitor code   |                                |              |                     |                  |              |   |  |  |      |              |         |       |          |              |         |               |               |            |         |
| Firestone   |                                |              |                     |                  |              |   |  |  |      |              |         |       |          |              |         |               |               |            |         |
| ContiTech<br>876 N1   |                                |              |                     |                  |              |   |  |  |      |              |         |       |          |              |         |               |               |            |         |
| GOODYEAR<br>8314  |                                |              |                     |                  |              |   |  |  |      |              |         |       |          |              |         |               |               |            |         |
| VIBRACOUSTIC  |                                |              |                     |                  |              |   |  |  |      |              |         |       |          |              |         |               |               |            |         |
| Code  | Manufacturer                   |              |                     |                  |              |   |  |  |      |              |         |       |          |              |         |               |               |            |         |
| 8139068   | IVECO                          |              |                     |                  |              |   |  |  |      |              |         |       |          |              |         |               |               |            |         |
| 41022620  |                                |              |                     |                  |              |   |  |  |      |              |         |       |          |              |         |               |               |            |         |
| 5.000296.816  | IRISBUS                        |              |                     |                  |              |   |  |  |      |              |         |       |          |              |         |               |               |            |         |
| 5.000.296.816   |                                |              |                     |                  |              |   |  |  |      |              |         |       |          |              |         |               |               |            |         |
| 5.000.296.827   |                                |              |                     |                  |              |   |  |  |      |              |         |       |          |              |         |               |               |            |         |
| 5000296816  | RENAULT                        |              |                     |                  |              |   |  |  |      |              |         |       |          |              |         |               |               |            |         |



# **Towing vehicle & Trailer & Semitrailer Air Springs**





# Towing vehicle & Trailer & Semitrailer Air Springs

| Code  | Section, Top View, Bottom View | Applications   |                          |                                 |                      |                      |  |  |      |              |               |     |               |     |               |        |  |      |
|---|--------------------------------|--|--------------------------|---------------------------------|----------------------|----------------------|--|--|------|--------------|---------------|-----|---------------|-----|---------------|--------|--|------|
| <b>FM18001.H01</b>  |                                |  |                          |                                 |                      |                      |  |  |      |              |               |     |               |     |               |        |  |      |
| <table border="1"> <tr><td>Competitor code</td></tr> <tr><td>Firestone<br/>W01-M58-8355</td></tr> <tr><td>ContiTech<br/>4882 N1 P01</td></tr> <tr><td>VIBRACOUSTIC<br/>V 1 DF 16-2 NP</td></tr> <tr><td>GOODYEAR<br/>1R10-702</td></tr> </table>                                | Competitor code                | Firestone<br>W01-M58-8355                              | ContiTech<br>4882 N1 P01 | VIBRACOUSTIC<br>V 1 DF 16-2 NP  | GOODYEAR<br>1R10-702 | <p>Piston: No</p>    | <table border="1"> <thead> <tr> <th>Code</th> <th>Manufacturer</th> </tr> </thead> <tbody> <tr> <td>81.43601.0151</td> <td>MAN</td> </tr> <tr> <td>81.43601.0176</td> <td>MAN</td> </tr> </tbody> </table>   |  | Code | Manufacturer | 81.43601.0151 | MAN | 81.43601.0176 | MAN |               |        |  |      |
| Competitor code   |                                |  |                          |                                 |                      |                      |  |  |      |              |               |     |               |     |               |        |  |      |
| Firestone<br>W01-M58-8355   |                                |  |                          |                                 |                      |                      |  |  |      |              |               |     |               |     |               |        |  |      |
| ContiTech<br>4882 N1 P01  |                                |  |                          |                                 |                      |                      |  |  |      |              |               |     |               |     |               |        |  |      |
| VIBRACOUSTIC<br>V 1 DF 16-2 NP  |                                |  |                          |                                 |                      |                      |  |  |      |              |               |     |               |     |               |        |  |      |
| GOODYEAR<br>1R10-702  |                                |  |                          |                                 |                      |                      |  |  |      |              |               |     |               |     |               |        |  |      |
| Code  | Manufacturer                   |  |                          |                                 |                      |                      |  |  |      |              |               |     |               |     |               |        |  |      |
| 81.43601.0151   | MAN                            |  |                          |                                 |                      |                      |  |  |      |              |               |     |               |     |               |        |  |      |
| 81.43601.0176   | MAN                            |  |                          |                                 |                      |                      |  |  |      |              |               |     |               |     |               |        |  |      |
| <b>FM18001.C01</b>  |                                |  |                          |                                 |                      |                      |  |  |      |              |               |     |               |     |               |        |  |      |
| <table border="1"> <tr><td>Competitor code</td></tr> <tr><td>Firestone<br/>1T17TWR-8<br/>W01-M58-8354<br/>W01-M58-9880</td></tr> <tr><td>ContiTech<br/>4882 N1 P05</td></tr> <tr><td>VIBRACOUSTIC<br/>V 1 DF 16P-933</td></tr> <tr><td>GOODYEAR<br/>1R10-709</td></tr> </table> | Competitor code                | Firestone<br>1T17TWR-8<br>W01-M58-8354<br>W01-M58-9880 | ContiTech<br>4882 N1 P05 | VIBRACOUSTIC<br>V 1 DF 16P-933  | GOODYEAR<br>1R10-709 | <p>Piston: Steel</p> | <table border="1"> <thead> <tr> <th>Code</th> <th>Manufacturer</th> </tr> </thead> <tbody> <tr> <td>81.43600.6036</td> <td>MAN</td> </tr> <tr> <td>81.43600.6056</td> <td>MAN</td> </tr> <tr> <td></td> <td>SITRAK</td> </tr> <tr> <td></td> <td>HOWO</td> </tr> </tbody> </table> |  | Code | Manufacturer | 81.43600.6036 | MAN | 81.43600.6056 | MAN |               | SITRAK |  | HOWO |
| Competitor code   |                                |  |                          |                                 |                      |                      |  |  |      |              |               |     |               |     |               |        |  |      |
| Firestone<br>1T17TWR-8<br>W01-M58-8354<br>W01-M58-9880  |                                |  |                          |                                 |                      |                      |  |  |      |              |               |     |               |     |               |        |  |      |
| ContiTech<br>4882 N1 P05  |                                |  |                          |                                 |                      |                      |  |  |      |              |               |     |               |     |               |        |  |      |
| VIBRACOUSTIC<br>V 1 DF 16P-933  |                                |  |                          |                                 |                      |                      |  |  |      |              |               |     |               |     |               |        |  |      |
| GOODYEAR<br>1R10-709  |                                |  |                          |                                 |                      |                      |  |  |      |              |               |     |               |     |               |        |  |      |
| Code  | Manufacturer                   |  |                          |                                 |                      |                      |  |  |      |              |               |     |               |     |               |        |  |      |
| 81.43600.6036   | MAN                            |  |                          |                                 |                      |                      |  |  |      |              |               |     |               |     |               |        |  |      |
| 81.43600.6056   | MAN                            |  |                          |                                 |                      |                      |  |  |      |              |               |     |               |     |               |        |  |      |
|   | SITRAK                         |  |                          |                                 |                      |                      |  |  |      |              |               |     |               |     |               |        |  |      |
|   | HOWO                           |  |                          |                                 |                      |                      |  |  |      |              |               |     |               |     |               |        |  |      |
| <b>FM18002.H01</b>  |                                |  |                          |                                 |                      |                      |  |  |      |              |               |     |               |     |               |        |  |      |
| <table border="1"> <tr><td>Competitor code</td></tr> <tr><td>Firestone<br/>1T17JR SERIES<br/>W01-M58-8361</td></tr> <tr><td>ContiTech<br/>4884 N1 P01</td></tr> <tr><td>VIBRACOUSTIC<br/>V 1 DF 19B-1 NP</td></tr> <tr><td>GOODYEAR<br/>1R11-820</td></tr> </table>             | Competitor code                | Firestone<br>1T17JR SERIES<br>W01-M58-8361             | ContiTech<br>4884 N1 P01 | VIBRACOUSTIC<br>V 1 DF 19B-1 NP | GOODYEAR<br>1R11-820 | <p>Piston: No</p>    | <table border="1"> <thead> <tr> <th>Code</th> <th>Manufacturer</th> </tr> </thead> <tbody> <tr> <td>81.43601.0174</td> <td>MAN</td> </tr> <tr> <td>81.43601.0175</td> <td>MAN</td> </tr> <tr> <td>81.43601.0152</td> <td>MAN</td> </tr> </tbody> </table>                          |  | Code | Manufacturer | 81.43601.0174 | MAN | 81.43601.0175 | MAN | 81.43601.0152 | MAN    |  |      |
| Competitor code   |                                |  |                          |                                 |                      |                      |  |  |      |              |               |     |               |     |               |        |  |      |
| Firestone<br>1T17JR SERIES<br>W01-M58-8361  |                                |  |                          |                                 |                      |                      |  |  |      |              |               |     |               |     |               |        |  |      |
| ContiTech<br>4884 N1 P01  |                                |  |                          |                                 |                      |                      |  |  |      |              |               |     |               |     |               |        |  |      |
| VIBRACOUSTIC<br>V 1 DF 19B-1 NP   |                                |  |                          |                                 |                      |                      |  |  |      |              |               |     |               |     |               |        |  |      |
| GOODYEAR<br>1R11-820  |                                |  |                          |                                 |                      |                      |  |  |      |              |               |     |               |     |               |        |  |      |
| Code  | Manufacturer                   |  |                          |                                 |                      |                      |  |  |      |              |               |     |               |     |               |        |  |      |
| 81.43601.0174   | MAN                            |  |                          |                                 |                      |                      |  |  |      |              |               |     |               |     |               |        |  |      |
| 81.43601.0175   | MAN                            |  |                          |                                 |                      |                      |  |  |      |              |               |     |               |     |               |        |  |      |
| 81.43601.0152   | MAN                            |  |                          |                                 |                      |                      |  |  |      |              |               |     |               |     |               |        |  |      |



# Towing vehicle & Trailer & Semitrailer Air Springs

| Code   | Section, Top View, Bottom View | Applications          |                         |
|--|--------------------------------|-----------------------|-------------------------|
| <b>FM18002.H02</b>                                     |                                |                       |                         |
| Competitor code  |                                | Code<br>81.43601.0173 | Manufacturer<br>MAN     |
| Firestone  |                                |                       |                         |
| ContiTech<br>4884 N1 P02                               |                                |                       |                         |
| VIBRACOUSTIC   |                                |                       |                         |
| GOODYEAR   |                                |                       |                         |
| <b>FM18002.C01</b>                                     |                                |                       |                         |
| Competitor code  |                                | Code<br>81.43600.6035 | Manufacturer<br>MAN     |
| Firestone<br>1T17JR7.2<br>W01-M58-8360<br>W01-M58-9879 |                                | Code<br>81.43600.6055 | Manufacturer<br>MAN     |
| ContiTech<br>4884 N1 P06                               |                                |                       | Manufacturer<br>FAW     |
| VIBRACOUSTIC<br>V 1 DF 21S-<br>490606                  |                                |                       | Manufacturer<br>SHACMAN |
| GOODYEAR<br>1R11-861                                   |                                |                       | Manufacturer<br>CNHTC   |
| <b>FM18002.C02</b>                                     |                                |                       |                         |
| Competitor code  |                                | Code<br>81.43600.6041 | Manufacturer<br>MAN     |
| Firestone<br>1T17JBR-8.0<br>W01-M58-8358               |                                |                       | Manufacturer<br>FAW     |
| ContiTech<br>4884 N1 P07                               |                                |                       | Manufacturer<br>SHACMAN |
| VIBRACOUSTIC   |                                |                       | Manufacturer<br>CNHTC   |
| GOODYEAR<br>1R11-885                                   |                                |                       |                         |



# Towing vehicle & Trailer & Semitrailer Air Springs

| Code  | Section, Top View, Bottom View | Applications                            |                         |                               |                      |                          |  |  |      |              |                |        |                |        |                |            |                |        |                |         |                |         |                |        |                |        |                |        |
|---|--------------------------------|---|-------------------------|-------------------------------|----------------------|--------------------------|--|--|------|--------------|----------------|--------|----------------|--------|----------------|------------|----------------|--------|----------------|---------|----------------|---------|----------------|--------|----------------|--------|----------------|--------|
| <b>FM18003.H01</b>  |                                |   |                         |                               |                      |                          |  |  |      |              |                |        |                |        |                |            |                |        |                |         |                |         |                |        |                |        |                |        |
| <table border="1"> <tr> <td>Competitor code</td> </tr> <tr> <td>Firestone<br/>1T66F-10.8<br/>W01-M58-8978</td> </tr> <tr> <td>ContiTech<br/>881 MB</td> </tr> <tr> <td>VIBRACOUSTIC<br/>V 1 DK 32</td> </tr> <tr> <td>GOODYEAR<br/>1R14-708</td> </tr> </table>         | Competitor code                | Firestone<br>1T66F-10.8<br>W01-M58-8978 | ContiTech<br>881 MB     | VIBRACOUSTIC<br>V 1 DK 32     | GOODYEAR<br>1R14-708 | <p>Piston: No</p>        | <table border="1"> <thead> <tr> <th>Code</th> <th>Manufacturer</th> </tr> </thead> <tbody> <tr> <td>05.429.40.01.0</td> <td>BPW 36</td> </tr> </tbody> </table>  |  | Code | Manufacturer | 05.429.40.01.0 | BPW 36 |                |        |                |            |                |        |                |         |                |         |                |        |                |        |                |        |
| Competitor code   |                                |   |                         |                               |                      |                          |  |  |      |              |                |        |                |        |                |            |                |        |                |         |                |         |                |        |                |        |                |        |
| Firestone<br>1T66F-10.8<br>W01-M58-8978   |                                |   |                         |                               |                      |                          |  |  |      |              |                |        |                |        |                |            |                |        |                |         |                |         |                |        |                |        |                |        |
| ContiTech<br>881 MB   |                                |   |                         |                               |                      |                          |  |  |      |              |                |        |                |        |                |            |                |        |                |         |                |         |                |        |                |        |                |        |
| VIBRACOUSTIC<br>V 1 DK 32   |                                |   |                         |                               |                      |                          |  |  |      |              |                |        |                |        |                |            |                |        |                |         |                |         |                |        |                |        |                |        |
| GOODYEAR<br>1R14-708  |                                |   |                         |                               |                      |                          |  |  |      |              |                |        |                |        |                |            |                |        |                |         |                |         |                |        |                |        |                |        |
| Code  | Manufacturer                   |   |                         |                               |                      |                          |  |  |      |              |                |        |                |        |                |            |                |        |                |         |                |         |                |        |                |        |                |        |
| 05.429.40.01.0  | BPW 36                         |   |                         |                               |                      |                          |  |  |      |              |                |        |                |        |                |            |                |        |                |         |                |         |                |        |                |        |                |        |
| <b>FM18003.C01</b>  |                                |   |                         |                               |                      |                          |  |  |      |              |                |        |                |        |                |            |                |        |                |         |                |         |                |        |                |        |                |        |
| <table border="1"> <tr> <td>Competitor code</td> </tr> <tr> <td>Firestone<br/>1T66F-10.8<br/>W01-M58-8966</td> </tr> <tr> <td>ContiTech<br/>881 MB P30</td> </tr> <tr> <td>VIBRACOUSTIC<br/>V 1 DK 32 X 9</td> </tr> <tr> <td>GOODYEAR<br/>1R14-712</td> </tr> </table> | Competitor code                | Firestone<br>1T66F-10.8<br>W01-M58-8966 | ContiTech<br>881 MB P30 | VIBRACOUSTIC<br>V 1 DK 32 X 9 | GOODYEAR<br>1R14-712 | <p>Piston: Steel</p>     | <table border="1"> <thead> <tr> <th>Code</th> <th>Manufacturer</th> </tr> </thead> <tbody> <tr><td>05.429.40.47.1</td><td>BPW 36</td></tr> <tr><td>05.429.40.50.1</td><td>BPW 36</td></tr> <tr><td>05.429.40.61.1</td><td>BPW 36</td></tr> <tr><td>05.429.41.21.1</td><td>BPW 36</td></tr> <tr><td>05.429.41.36.1</td><td>BPW 36</td></tr> <tr><td>05.429.41.42.1</td><td>BPW 36</td></tr> <tr><td>05.429.40.02.0</td><td>BPW 36</td></tr> <tr><td>05.429.40.02.1</td><td>BPW 36</td></tr> <tr><td>05.429.40.08.1</td><td>BPW 36</td></tr> </tbody> </table> |  | Code | Manufacturer | 05.429.40.47.1 | BPW 36 | 05.429.40.50.1 | BPW 36 | 05.429.40.61.1 | BPW 36     | 05.429.41.21.1 | BPW 36 | 05.429.41.36.1 | BPW 36  | 05.429.41.42.1 | BPW 36  | 05.429.40.02.0 | BPW 36 | 05.429.40.02.1 | BPW 36 | 05.429.40.08.1 | BPW 36 |
| Competitor code   |                                |   |                         |                               |                      |                          |  |  |      |              |                |        |                |        |                |            |                |        |                |         |                |         |                |        |                |        |                |        |
| Firestone<br>1T66F-10.8<br>W01-M58-8966   |                                |   |                         |                               |                      |                          |  |  |      |              |                |        |                |        |                |            |                |        |                |         |                |         |                |        |                |        |                |        |
| ContiTech<br>881 MB P30   |                                |   |                         |                               |                      |                          |  |  |      |              |                |        |                |        |                |            |                |        |                |         |                |         |                |        |                |        |                |        |
| VIBRACOUSTIC<br>V 1 DK 32 X 9   |                                |   |                         |                               |                      |                          |  |  |      |              |                |        |                |        |                |            |                |        |                |         |                |         |                |        |                |        |                |        |
| GOODYEAR<br>1R14-712  |                                |   |                         |                               |                      |                          |  |  |      |              |                |        |                |        |                |            |                |        |                |         |                |         |                |        |                |        |                |        |
| Code  | Manufacturer                   |   |                         |                               |                      |                          |  |  |      |              |                |        |                |        |                |            |                |        |                |         |                |         |                |        |                |        |                |        |
| 05.429.40.47.1  | BPW 36                         |   |                         |                               |                      |                          |  |  |      |              |                |        |                |        |                |            |                |        |                |         |                |         |                |        |                |        |                |        |
| 05.429.40.50.1  | BPW 36                         |   |                         |                               |                      |                          |  |  |      |              |                |        |                |        |                |            |                |        |                |         |                |         |                |        |                |        |                |        |
| 05.429.40.61.1  | BPW 36                         |   |                         |                               |                      |                          |  |  |      |              |                |        |                |        |                |            |                |        |                |         |                |         |                |        |                |        |                |        |
| 05.429.41.21.1  | BPW 36                         |   |                         |                               |                      |                          |  |  |      |              |                |        |                |        |                |            |                |        |                |         |                |         |                |        |                |        |                |        |
| 05.429.41.36.1  | BPW 36                         |   |                         |                               |                      |                          |  |  |      |              |                |        |                |        |                |            |                |        |                |         |                |         |                |        |                |        |                |        |
| 05.429.41.42.1  | BPW 36                         |   |                         |                               |                      |                          |  |  |      |              |                |        |                |        |                |            |                |        |                |         |                |         |                |        |                |        |                |        |
| 05.429.40.02.0  | BPW 36                         |   |                         |                               |                      |                          |  |  |      |              |                |        |                |        |                |            |                |        |                |         |                |         |                |        |                |        |                |        |
| 05.429.40.02.1  | BPW 36                         |   |                         |                               |                      |                          |  |  |      |              |                |        |                |        |                |            |                |        |                |         |                |         |                |        |                |        |                |        |
| 05.429.40.08.1  | BPW 36                         |   |                         |                               |                      |                          |  |  |      |              |                |        |                |        |                |            |                |        |                |         |                |         |                |        |                |        |                |        |
| <b>FM18002.C02P</b>   |                                |   |                         |                               |                      |                          |  |  |      |              |                |        |                |        |                |            |                |        |                |         |                |         |                |        |                |        |                |        |
| <table border="1"> <tr> <td>Competitor code</td> </tr> <tr> <td>Firestone<br/>1T66F-10.8<br/>W01-M58-8667</td> </tr> <tr> <td>ContiTech<br/>881 MB P30</td> </tr> <tr> <td>VIBRACOUSTIC<br/>V 1 DK 32 Y 9</td> </tr> <tr> <td>GOODYEAR<br/>1R14-748</td> </tr> </table> | Competitor code                | Firestone<br>1T66F-10.8<br>W01-M58-8667 | ContiTech<br>881 MB P30 | VIBRACOUSTIC<br>V 1 DK 32 Y 9 | GOODYEAR<br>1R14-748 | <p>Piston: Composite</p> | <table border="1"> <thead> <tr> <th>Code</th> <th>Manufacturer</th> </tr> </thead> <tbody> <tr><td>05.429.43.38.0</td><td>BPW 36</td></tr> <tr><td>05.429.43.51.0</td><td>BPW 36</td></tr> <tr><td>6-AB8003-0100</td><td>HUFFERMANN</td></tr> <tr><td>2198330</td><td>SCANIA</td></tr> <tr><td>750 496</td><td>SCHMITZ</td></tr> <tr><td>751 549</td><td>SCHMITZ</td></tr> </tbody> </table>   |  | Code | Manufacturer | 05.429.43.38.0 | BPW 36 | 05.429.43.51.0 | BPW 36 | 6-AB8003-0100  | HUFFERMANN | 2198330        | SCANIA | 750 496        | SCHMITZ | 751 549        | SCHMITZ |                |        |                |        |                |        |
| Competitor code   |                                |   |                         |                               |                      |                          |  |  |      |              |                |        |                |        |                |            |                |        |                |         |                |         |                |        |                |        |                |        |
| Firestone<br>1T66F-10.8<br>W01-M58-8667   |                                |   |                         |                               |                      |                          |  |  |      |              |                |        |                |        |                |            |                |        |                |         |                |         |                |        |                |        |                |        |
| ContiTech<br>881 MB P30   |                                |   |                         |                               |                      |                          |  |  |      |              |                |        |                |        |                |            |                |        |                |         |                |         |                |        |                |        |                |        |
| VIBRACOUSTIC<br>V 1 DK 32 Y 9   |                                |   |                         |                               |                      |                          |  |  |      |              |                |        |                |        |                |            |                |        |                |         |                |         |                |        |                |        |                |        |
| GOODYEAR<br>1R14-748  |                                |   |                         |                               |                      |                          |  |  |      |              |                |        |                |        |                |            |                |        |                |         |                |         |                |        |                |        |                |        |
| Code  | Manufacturer                   |   |                         |                               |                      |                          |  |  |      |              |                |        |                |        |                |            |                |        |                |         |                |         |                |        |                |        |                |        |
| 05.429.43.38.0  | BPW 36                         |   |                         |                               |                      |                          |  |  |      |              |                |        |                |        |                |            |                |        |                |         |                |         |                |        |                |        |                |        |
| 05.429.43.51.0  | BPW 36                         |   |                         |                               |                      |                          |  |  |      |              |                |        |                |        |                |            |                |        |                |         |                |         |                |        |                |        |                |        |
| 6-AB8003-0100   | HUFFERMANN                     |   |                         |                               |                      |                          |  |  |      |              |                |        |                |        |                |            |                |        |                |         |                |         |                |        |                |        |                |        |
| 2198330   | SCANIA                         |   |                         |                               |                      |                          |  |  |      |              |                |        |                |        |                |            |                |        |                |         |                |         |                |        |                |        |                |        |
| 750 496   | SCHMITZ                        |   |                         |                               |                      |                          |  |  |      |              |                |        |                |        |                |            |                |        |                |         |                |         |                |        |                |        |                |        |
| 751 549   | SCHMITZ                        |   |                         |                               |                      |                          |  |  |      |              |                |        |                |        |                |            |                |        |                |         |                |         |                |        |                |        |                |        |

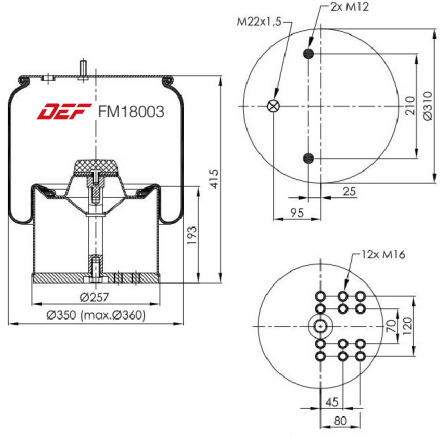
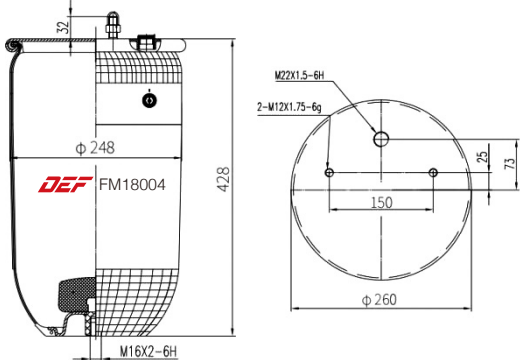
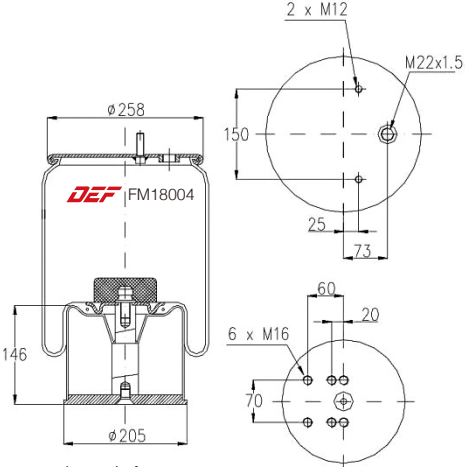

# Towing vehicle & Trailer & Semitrailer Air Springs

| Code   | Section, Top View, Bottom View | Applications                            |                         |                               |                      |  |   |      |              |                |         |                |         |                |         |                |         |                |         |                |        |                |        |                |        |                |        |
|--|--------------------------------|---|-------------------------|-------------------------------|----------------------|--|---|------|--------------|----------------|---------|----------------|---------|----------------|---------|----------------|---------|----------------|---------|----------------|--------|----------------|--------|----------------|--------|----------------|--------|
| <b>FM18003.C03FT</b>   |                                |   |                         |                               |                      |  |   |      |              |                |         |                |         |                |         |                |         |                |         |                |        |                |        |                |        |                |        |
| <table border="1"> <tr> <td data-bbox="161 426 373 491">Competitor code</td> </tr> <tr> <td data-bbox="161 495 373 592">Firestone<br/>1T66F-10.8<br/>W01-M58-8966</td> </tr> <tr> <td data-bbox="161 597 373 672">ContiTech<br/>881 MB P30</td> </tr> <tr> <td data-bbox="161 676 373 752">VIBRACOUSTIC<br/>V 1 DK 32 X 9</td> </tr> <tr> <td data-bbox="161 756 373 832">GOODYEAR<br/>1R14-712</td> </tr> </table>          | Competitor code                | Firestone<br>1T66F-10.8<br>W01-M58-8966 | ContiTech<br>881 MB P30 | VIBRACOUSTIC<br>V 1 DK 32 X 9 | GOODYEAR<br>1R14-712 |  <p data-bbox="392 879 587 911">Piston: Composite</p> | <table border="1"> <thead> <tr> <th data-bbox="959 426 1182 454">Code</th> <th data-bbox="1185 426 1433 454">Manufacturer</th> </tr> </thead> <tbody> <tr><td>05.429.40.47.1</td><td>BPW 36</td></tr> <tr><td>05.429.40.50.1</td><td>BPW 36</td></tr> <tr><td>05.429.40.61.1</td><td>BPW 36</td></tr> <tr><td>05.429.41.21.1</td><td>BPW 36</td></tr> <tr><td>05.429.41.36.1</td><td>BPW 36</td></tr> <tr><td>05.429.41.42.1</td><td>BPW 36</td></tr> <tr><td>05.429.40.02.0</td><td>BPW 36</td></tr> <tr><td>05.429.40.02.1</td><td>BPW 36</td></tr> <tr><td>05.429.40.08.1</td><td>BPW 36</td></tr> </tbody> </table> | Code | Manufacturer | 05.429.40.47.1 | BPW 36  | 05.429.40.50.1 | BPW 36  | 05.429.40.61.1 | BPW 36  | 05.429.41.21.1 | BPW 36  | 05.429.41.36.1 | BPW 36  | 05.429.41.42.1 | BPW 36 | 05.429.40.02.0 | BPW 36 | 05.429.40.02.1 | BPW 36 | 05.429.40.08.1 | BPW 36 |
| Competitor code  |                                |   |                         |                               |                      |  |   |      |              |                |         |                |         |                |         |                |         |                |         |                |        |                |        |                |        |                |        |
| Firestone<br>1T66F-10.8<br>W01-M58-8966  |                                |   |                         |                               |                      |  |   |      |              |                |         |                |         |                |         |                |         |                |         |                |        |                |        |                |        |                |        |
| ContiTech<br>881 MB P30  |                                |   |                         |                               |                      |  |   |      |              |                |         |                |         |                |         |                |         |                |         |                |        |                |        |                |        |                |        |
| VIBRACOUSTIC<br>V 1 DK 32 X 9  |                                |   |                         |                               |                      |  |   |      |              |                |         |                |         |                |         |                |         |                |         |                |        |                |        |                |        |                |        |
| GOODYEAR<br>1R14-712   |                                |   |                         |                               |                      |  |   |      |              |                |         |                |         |                |         |                |         |                |         |                |        |                |        |                |        |                |        |
| Code   | Manufacturer                   |   |                         |                               |                      |  |   |      |              |                |         |                |         |                |         |                |         |                |         |                |        |                |        |                |        |                |        |
| 05.429.40.47.1   | BPW 36                         |   |                         |                               |                      |  |   |      |              |                |         |                |         |                |         |                |         |                |         |                |        |                |        |                |        |                |        |
| 05.429.40.50.1   | BPW 36                         |   |                         |                               |                      |  |   |      |              |                |         |                |         |                |         |                |         |                |         |                |        |                |        |                |        |                |        |
| 05.429.40.61.1   | BPW 36                         |   |                         |                               |                      |  |   |      |              |                |         |                |         |                |         |                |         |                |         |                |        |                |        |                |        |                |        |
| 05.429.41.21.1   | BPW 36                         |   |                         |                               |                      |  |   |      |              |                |         |                |         |                |         |                |         |                |         |                |        |                |        |                |        |                |        |
| 05.429.41.36.1   | BPW 36                         |   |                         |                               |                      |  |   |      |              |                |         |                |         |                |         |                |         |                |         |                |        |                |        |                |        |                |        |
| 05.429.41.42.1   | BPW 36                         |   |                         |                               |                      |  |   |      |              |                |         |                |         |                |         |                |         |                |         |                |        |                |        |                |        |                |        |
| 05.429.40.02.0   | BPW 36                         |   |                         |                               |                      |  |   |      |              |                |         |                |         |                |         |                |         |                |         |                |        |                |        |                |        |                |        |
| 05.429.40.02.1   | BPW 36                         |   |                         |                               |                      |  |   |      |              |                |         |                |         |                |         |                |         |                |         |                |        |                |        |                |        |                |        |
| 05.429.40.08.1   | BPW 36                         |   |                         |                               |                      |  |   |      |              |                |         |                |         |                |         |                |         |                |         |                |        |                |        |                |        |                |        |
| <b>FM18004.H01</b>   |                                |   |                         |                               |                      |  |   |      |              |                |         |                |         |                |         |                |         |                |         |                |        |                |        |                |        |                |        |
| <table border="1"> <tr> <td data-bbox="161 987 373 1052">Competitor code</td> </tr> <tr> <td data-bbox="161 1056 373 1153">Firestone<br/>1T66F-10.8<br/>W01-M58-8966</td> </tr> <tr> <td data-bbox="161 1157 373 1233">ContiTech<br/>881 MB P30</td> </tr> <tr> <td data-bbox="161 1237 373 1313">VIBRACOUSTIC<br/>V 1 DK 32 X 9</td> </tr> <tr> <td data-bbox="161 1317 373 1392">GOODYEAR<br/>1R14-712</td> </tr> </table> | Competitor code                | Firestone<br>1T66F-10.8<br>W01-M58-8966 | ContiTech<br>881 MB P30 | VIBRACOUSTIC<br>V 1 DK 32 X 9 | GOODYEAR<br>1R14-712 |  <p data-bbox="392 1364 504 1397">Piston: No</p>     | <table border="1"> <thead> <tr> <th data-bbox="959 987 1182 1015">Code</th> <th data-bbox="1185 987 1433 1015">Manufacturer</th> </tr> </thead> <tbody> <tr> <td data-bbox="959 1019 1182 1047">05.429.40.91.0</td> <td data-bbox="1185 1019 1433 1047">BPW 30K</td> </tr> </tbody> </table>  | Code | Manufacturer | 05.429.40.91.0 | BPW 30K |                |         |                |         |                |         |                |         |                |        |                |        |                |        |                |        |
| Competitor code  |                                |   |                         |                               |                      |  |   |      |              |                |         |                |         |                |         |                |         |                |         |                |        |                |        |                |        |                |        |
| Firestone<br>1T66F-10.8<br>W01-M58-8966  |                                |   |                         |                               |                      |  |   |      |              |                |         |                |         |                |         |                |         |                |         |                |        |                |        |                |        |                |        |
| ContiTech<br>881 MB P30  |                                |   |                         |                               |                      |  |   |      |              |                |         |                |         |                |         |                |         |                |         |                |        |                |        |                |        |                |        |
| VIBRACOUSTIC<br>V 1 DK 32 X 9  |                                |   |                         |                               |                      |  |   |      |              |                |         |                |         |                |         |                |         |                |         |                |        |                |        |                |        |                |        |
| GOODYEAR<br>1R14-712   |                                |   |                         |                               |                      |  |   |      |              |                |         |                |         |                |         |                |         |                |         |                |        |                |        |                |        |                |        |
| Code   | Manufacturer                   |   |                         |                               |                      |  |   |      |              |                |         |                |         |                |         |                |         |                |         |                |        |                |        |                |        |                |        |
| 05.429.40.91.0   | BPW 30K                        |   |                         |                               |                      |  |   |      |              |                |         |                |         |                |         |                |         |                |         |                |        |                |        |                |        |                |        |
| <b>FM18004.C01</b>   |                                |   |                         |                               |                      |  |   |      |              |                |         |                |         |                |         |                |         |                |         |                |        |                |        |                |        |                |        |
| <table border="1"> <tr> <td data-bbox="161 1483 373 1548">Competitor code</td> </tr> <tr> <td data-bbox="161 1552 373 1649">Firestone<br/>1T17D-4.3<br/>W01-M58-8609</td> </tr> <tr> <td data-bbox="161 1653 373 1729">ContiTech<br/>940 MB P30</td> </tr> <tr> <td data-bbox="161 1733 373 1808">VIBRACOUSTIC<br/>V 1 DK 21KX-4</td> </tr> <tr> <td data-bbox="161 1813 373 1888">GOODYEAR<br/>1R14-763</td> </tr> </table> | Competitor code                | Firestone<br>1T17D-4.3<br>W01-M58-8609  | ContiTech<br>940 MB P30 | VIBRACOUSTIC<br>V 1 DK 21KX-4 | GOODYEAR<br>1R14-763 |  <p data-bbox="392 1957 528 1989">Piston: Steel</p> | <table border="1"> <thead> <tr> <th data-bbox="959 1483 1182 1511">Code</th> <th data-bbox="1185 1483 1433 1511">Manufacturer</th> </tr> </thead> <tbody> <tr><td>05.429.41.14.1</td><td>BPW 30K</td></tr> <tr><td>05.429.41.23.1</td><td>BPW 30K</td></tr> <tr><td>05.429.41.27.1</td><td>BPW 30K</td></tr> <tr><td>05.429.41.53.1</td><td>BPW 30K</td></tr> <tr><td>05.429.42.19.1</td><td>BPW 30K</td></tr> </tbody> </table>  | Code | Manufacturer | 05.429.41.14.1 | BPW 30K | 05.429.41.23.1 | BPW 30K | 05.429.41.27.1 | BPW 30K | 05.429.41.53.1 | BPW 30K | 05.429.42.19.1 | BPW 30K |                |        |                |        |                |        |                |        |
| Competitor code  |                                |   |                         |                               |                      |  |   |      |              |                |         |                |         |                |         |                |         |                |         |                |        |                |        |                |        |                |        |
| Firestone<br>1T17D-4.3<br>W01-M58-8609   |                                |   |                         |                               |                      |  |   |      |              |                |         |                |         |                |         |                |         |                |         |                |        |                |        |                |        |                |        |
| ContiTech<br>940 MB P30  |                                |   |                         |                               |                      |  |   |      |              |                |         |                |         |                |         |                |         |                |         |                |        |                |        |                |        |                |        |
| VIBRACOUSTIC<br>V 1 DK 21KX-4  |                                |   |                         |                               |                      |  |   |      |              |                |         |                |         |                |         |                |         |                |         |                |        |                |        |                |        |                |        |
| GOODYEAR<br>1R14-763   |                                |   |                         |                               |                      |  |   |      |              |                |         |                |         |                |         |                |         |                |         |                |        |                |        |                |        |                |        |
| Code   | Manufacturer                   |   |                         |                               |                      |  |   |      |              |                |         |                |         |                |         |                |         |                |         |                |        |                |        |                |        |                |        |
| 05.429.41.14.1   | BPW 30K                        |   |                         |                               |                      |  |   |      |              |                |         |                |         |                |         |                |         |                |         |                |        |                |        |                |        |                |        |
| 05.429.41.23.1   | BPW 30K                        |   |                         |                               |                      |  |   |      |              |                |         |                |         |                |         |                |         |                |         |                |        |                |        |                |        |                |        |
| 05.429.41.27.1   | BPW 30K                        |   |                         |                               |                      |  |   |      |              |                |         |                |         |                |         |                |         |                |         |                |        |                |        |                |        |                |        |
| 05.429.41.53.1   | BPW 30K                        |   |                         |                               |                      |  |   |      |              |                |         |                |         |                |         |                |         |                |         |                |        |                |        |                |        |                |        |
| 05.429.42.19.1   | BPW 30K                        |   |                         |                               |                      |  |   |      |              |                |         |                |         |                |         |                |         |                |         |                |        |                |        |                |        |                |        |



# Towing vehicle & Trailer & Semitrailer Air Springs

| Code  | Section, Top View, Bottom View | Applications                              |                         |                               |                       |                          |   |      |              |                |         |                |         |                |        |                |         |                |         |                |        |                |        |
|---|--------------------------------|---|-------------------------|-------------------------------|-----------------------|--------------------------|---|------|--------------|----------------|---------|----------------|---------|----------------|--------|----------------|---------|----------------|---------|----------------|--------|----------------|--------|
| <b>FM18004.C02P</b>   |                                |   |                         |                               |                       |                          |   |      |              |                |         |                |         |                |        |                |         |                |         |                |        |                |        |
| <table border="1" style="width: 100%; border-collapse: collapse;"> <tr> <td style="padding: 2px;">Competitor code</td> </tr> <tr> <td style="padding: 2px;">Firestone<br/>1T17D-4.3<br/>W01-M58-8585</td> </tr> <tr> <td style="padding: 2px;">ContiTech<br/>940 MB P30</td> </tr> <tr> <td style="padding: 2px;">VIBRACOUSTIC<br/>V 1 DK 21KY-4</td> </tr> <tr> <td style="padding: 2px;">GOODYEAR<br/>1R14-7523</td> </tr> </table>   | Competitor code                | Firestone<br>1T17D-4.3<br>W01-M58-8585    | ContiTech<br>940 MB P30 | VIBRACOUSTIC<br>V 1 DK 21KY-4 | GOODYEAR<br>1R14-7523 | <p>Piston: Composite</p> | <table border="1" style="width: 100%; border-collapse: collapse;"> <thead> <tr> <th style="width: 50%;">Code</th> <th style="width: 50%;">Manufacturer</th> </tr> </thead> <tbody> <tr> <td>05.429.43.21.0</td> <td>BPW 30K</td> </tr> <tr> <td>05.429.43.37.0</td> <td>BPW 30K</td> </tr> <tr> <td>2198483</td> <td>SCANIA</td> </tr> <tr> <td>751 084</td> <td>SCHMITZ</td> </tr> <tr> <td>017 331</td> <td>SCHMITZ</td> </tr> </tbody> </table>  | Code | Manufacturer | 05.429.43.21.0 | BPW 30K | 05.429.43.37.0 | BPW 30K | 2198483        | SCANIA | 751 084        | SCHMITZ | 017 331        | SCHMITZ |                |        |                |        |
| Competitor code   |                                |   |                         |                               |                       |                          |   |      |              |                |         |                |         |                |        |                |         |                |         |                |        |                |        |
| Firestone<br>1T17D-4.3<br>W01-M58-8585  |                                |   |                         |                               |                       |                          |   |      |              |                |         |                |         |                |        |                |         |                |         |                |        |                |        |
| ContiTech<br>940 MB P30   |                                |   |                         |                               |                       |                          |   |      |              |                |         |                |         |                |        |                |         |                |         |                |        |                |        |
| VIBRACOUSTIC<br>V 1 DK 21KY-4   |                                |   |                         |                               |                       |                          |   |      |              |                |         |                |         |                |        |                |         |                |         |                |        |                |        |
| GOODYEAR<br>1R14-7523   |                                |   |                         |                               |                       |                          |   |      |              |                |         |                |         |                |        |                |         |                |         |                |        |                |        |
| Code  | Manufacturer                   |   |                         |                               |                       |                          |   |      |              |                |         |                |         |                |        |                |         |                |         |                |        |                |        |
| 05.429.43.21.0  | BPW 30K                        |   |                         |                               |                       |                          |   |      |              |                |         |                |         |                |        |                |         |                |         |                |        |                |        |
| 05.429.43.37.0  | BPW 30K                        |   |                         |                               |                       |                          |   |      |              |                |         |                |         |                |        |                |         |                |         |                |        |                |        |
| 2198483   | SCANIA                         |   |                         |                               |                       |                          |   |      |              |                |         |                |         |                |        |                |         |                |         |                |        |                |        |
| 751 084   | SCHMITZ                        |   |                         |                               |                       |                          |   |      |              |                |         |                |         |                |        |                |         |                |         |                |        |                |        |
| 017 331   | SCHMITZ                        |   |                         |                               |                       |                          |   |      |              |                |         |                |         |                |        |                |         |                |         |                |        |                |        |
| <b>FM18005.H01</b>  |                                |   |                         |                               |                       |                          |   |      |              |                |         |                |         |                |        |                |         |                |         |                |        |                |        |
| <table border="1" style="width: 100%; border-collapse: collapse;"> <tr> <td style="padding: 2px;">Competitor code</td> </tr> <tr> <td style="padding: 2px;">Firestone<br/>1T17D-8.3<br/>W01-M58-8620</td> </tr> <tr> <td style="padding: 2px;">ContiTech<br/>941 MB</td> </tr> <tr> <td style="padding: 2px;">VIBRACOUSTIC<br/>V 1 DK 21</td> </tr> <tr> <td style="padding: 2px;">GOODYEAR<br/>1R11-700</td> </tr> </table>            | Competitor code                | Firestone<br>1T17D-8.3<br>W01-M58-8620    | ContiTech<br>941 MB     | VIBRACOUSTIC<br>V 1 DK 21     | GOODYEAR<br>1R11-700  | <p>Piston: No</p>        | <table border="1" style="width: 100%; border-collapse: collapse;"> <thead> <tr> <th style="width: 50%;">Code</th> <th style="width: 50%;">Manufacturer</th> </tr> </thead> <tbody> <tr> <td>05.429.40.03.0</td> <td>BPW 30</td> </tr> <tr> <td>015 514</td> <td>SCHMITZ</td> </tr> </tbody> </table>  | Code | Manufacturer | 05.429.40.03.0 | BPW 30  | 015 514        | SCHMITZ |                |        |                |         |                |         |                |        |                |        |
| Competitor code   |                                |   |                         |                               |                       |                          |   |      |              |                |         |                |         |                |        |                |         |                |         |                |        |                |        |
| Firestone<br>1T17D-8.3<br>W01-M58-8620  |                                |   |                         |                               |                       |                          |   |      |              |                |         |                |         |                |        |                |         |                |         |                |        |                |        |
| ContiTech<br>941 MB   |                                |   |                         |                               |                       |                          |   |      |              |                |         |                |         |                |        |                |         |                |         |                |        |                |        |
| VIBRACOUSTIC<br>V 1 DK 21   |                                |   |                         |                               |                       |                          |   |      |              |                |         |                |         |                |        |                |         |                |         |                |        |                |        |
| GOODYEAR<br>1R11-700  |                                |   |                         |                               |                       |                          |   |      |              |                |         |                |         |                |        |                |         |                |         |                |        |                |        |
| Code  | Manufacturer                   |   |                         |                               |                       |                          |   |      |              |                |         |                |         |                |        |                |         |                |         |                |        |                |        |
| 05.429.40.03.0  | BPW 30                         |   |                         |                               |                       |                          |   |      |              |                |         |                |         |                |        |                |         |                |         |                |        |                |        |
| 015 514   | SCHMITZ                        |   |                         |                               |                       |                          |   |      |              |                |         |                |         |                |        |                |         |                |         |                |        |                |        |
| <b>FM18005.C01</b>  |                                |   |                         |                               |                       |                          |   |      |              |                |         |                |         |                |        |                |         |                |         |                |        |                |        |
| <table border="1" style="width: 100%; border-collapse: collapse;"> <tr> <td style="padding: 2px;">Competitor code</td> </tr> <tr> <td style="padding: 2px;">Firestone<br/>1T17D SERIES<br/>W01-M58-8619</td> </tr> <tr> <td style="padding: 2px;">ContiTech<br/>941 MB P30</td> </tr> <tr> <td style="padding: 2px;">VIBRACOUSTIC<br/>V 1 DK 21 X 1</td> </tr> <tr> <td style="padding: 2px;">GOODYEAR<br/>1R11-762</td> </tr> </table> | Competitor code                | Firestone<br>1T17D SERIES<br>W01-M58-8619 | ContiTech<br>941 MB P30 | VIBRACOUSTIC<br>V 1 DK 21 X 1 | GOODYEAR<br>1R11-762  | <p>Piston: Steel</p>     | <table border="1" style="width: 100%; border-collapse: collapse;"> <thead> <tr> <th style="width: 50%;">Code</th> <th style="width: 50%;">Manufacturer</th> </tr> </thead> <tbody> <tr> <td>05.429.41.28.1</td> <td>BPW 30</td> </tr> <tr> <td>05.429.40.10.1</td> <td>BPW 30</td> </tr> <tr> <td>05.429.40.28.1</td> <td>BPW 30</td> </tr> <tr> <td>05.429.40.36.1</td> <td>BPW 30</td> </tr> <tr> <td>05.429.40.52.1</td> <td>BPW 30</td> </tr> <tr> <td>05.429.40.64.1</td> <td>BPW 30</td> </tr> <tr> <td>05.429.41.24.1</td> <td>BPW 30</td> </tr> </tbody> </table> | Code | Manufacturer | 05.429.41.28.1 | BPW 30  | 05.429.40.10.1 | BPW 30  | 05.429.40.28.1 | BPW 30 | 05.429.40.36.1 | BPW 30  | 05.429.40.52.1 | BPW 30  | 05.429.40.64.1 | BPW 30 | 05.429.41.24.1 | BPW 30 |
| Competitor code   |                                |   |                         |                               |                       |                          |   |      |              |                |         |                |         |                |        |                |         |                |         |                |        |                |        |
| Firestone<br>1T17D SERIES<br>W01-M58-8619   |                                |   |                         |                               |                       |                          |   |      |              |                |         |                |         |                |        |                |         |                |         |                |        |                |        |
| ContiTech<br>941 MB P30   |                                |   |                         |                               |                       |                          |   |      |              |                |         |                |         |                |        |                |         |                |         |                |        |                |        |
| VIBRACOUSTIC<br>V 1 DK 21 X 1   |                                |   |                         |                               |                       |                          |   |      |              |                |         |                |         |                |        |                |         |                |         |                |        |                |        |
| GOODYEAR<br>1R11-762  |                                |   |                         |                               |                       |                          |   |      |              |                |         |                |         |                |        |                |         |                |         |                |        |                |        |
| Code  | Manufacturer                   |   |                         |                               |                       |                          |   |      |              |                |         |                |         |                |        |                |         |                |         |                |        |                |        |
| 05.429.41.28.1  | BPW 30                         |   |                         |                               |                       |                          |   |      |              |                |         |                |         |                |        |                |         |                |         |                |        |                |        |
| 05.429.40.10.1  | BPW 30                         |   |                         |                               |                       |                          |   |      |              |                |         |                |         |                |        |                |         |                |         |                |        |                |        |
| 05.429.40.28.1  | BPW 30                         |   |                         |                               |                       |                          |   |      |              |                |         |                |         |                |        |                |         |                |         |                |        |                |        |
| 05.429.40.36.1  | BPW 30                         |   |                         |                               |                       |                          |   |      |              |                |         |                |         |                |        |                |         |                |         |                |        |                |        |
| 05.429.40.52.1  | BPW 30                         |   |                         |                               |                       |                          |   |      |              |                |         |                |         |                |        |                |         |                |         |                |        |                |        |
| 05.429.40.64.1  | BPW 30                         |   |                         |                               |                       |                          |   |      |              |                |         |                |         |                |        |                |         |                |         |                |        |                |        |
| 05.429.41.24.1  | BPW 30                         |   |                         |                               |                       |                          |   |      |              |                |         |                |         |                |        |                |         |                |         |                |        |                |        |



# Towing vehicle & Trailer & Semitrailer Air Springs

| Code  | Section, Top View, Bottom View | Applications                            |                         |                               |                      |   |   |      |              |              |                |        |         |         |         |         |         |        |
|---|--------------------------------|---|-------------------------|-------------------------------|----------------------|---|---|------|--------------|--------------|----------------|--------|---------|---------|---------|---------|---------|--------|
| <b>FM18005.C02P</b>   |                                |   |                         |                               |                      |   |   |      |              |              |                |        |         |         |         |         |         |        |
| <table border="1"> <tr> <td>Competitor code</td> </tr> <tr> <td>Firestone<br/>1T17J-10.3<br/>W01-M58-8668</td> </tr> <tr> <td>ContiTech<br/>941 MB P30</td> </tr> <tr> <td>VIBRACOUSTIC<br/>V 1 DK 21 Y 1</td> </tr> <tr> <td>GOODYEAR<br/>1R11-743</td> </tr> </table> | Competitor code                | Firestone<br>1T17J-10.3<br>W01-M58-8668 | ContiTech<br>941 MB P30 | VIBRACOUSTIC<br>V 1 DK 21 Y 1 | GOODYEAR<br>1R11-743 | <p>Piston: Composite</p>  | <table border="1"> <thead> <tr> <th>Code</th> <th>Manufacturer</th> </tr> </thead> <tbody> <tr> <td>05.429.43.20.0</td> <td>BPW 30</td> </tr> <tr> <td>015 502</td> <td>SCHMITZ</td> </tr> <tr> <td>017 109</td> <td>SCHMITZ</td> </tr> <tr> <td>2338887</td> <td>SCANIA</td> </tr> </tbody> </table> |      | Code         | Manufacturer | 05.429.43.20.0 | BPW 30 | 015 502 | SCHMITZ | 017 109 | SCHMITZ | 2338887 | SCANIA |
| Competitor code   |                                |   |                         |                               |                      |   |   |      |              |              |                |        |         |         |         |         |         |        |
| Firestone<br>1T17J-10.3<br>W01-M58-8668   |                                |   |                         |                               |                      |   |   |      |              |              |                |        |         |         |         |         |         |        |
| ContiTech<br>941 MB P30   |                                |   |                         |                               |                      |   |   |      |              |              |                |        |         |         |         |         |         |        |
| VIBRACOUSTIC<br>V 1 DK 21 Y 1   |                                |   |                         |                               |                      |   |   |      |              |              |                |        |         |         |         |         |         |        |
| GOODYEAR<br>1R11-743  |                                |   |                         |                               |                      |   |   |      |              |              |                |        |         |         |         |         |         |        |
| Code  | Manufacturer                   |   |                         |                               |                      |   |   |      |              |              |                |        |         |         |         |         |         |        |
| 05.429.43.20.0  | BPW 30                         |   |                         |                               |                      |   |   |      |              |              |                |        |         |         |         |         |         |        |
| 015 502   | SCHMITZ                        |   |                         |                               |                      |   |   |      |              |              |                |        |         |         |         |         |         |        |
| 017 109   | SCHMITZ                        |   |                         |                               |                      |   |   |      |              |              |                |        |         |         |         |         |         |        |
| 2338887   | SCANIA                         |   |                         |                               |                      |   |   |      |              |              |                |        |         |         |         |         |         |        |
| <b>FM18006.H01</b>  |                                |   |                         |                               |                      |   |   |      |              |              |                |        |         |         |         |         |         |        |
| <table border="1"> <tr> <td>Competitor code</td> </tr> <tr> <td>Firestone<br/>1T19L-7<br/>W01-M58-7237</td> </tr> <tr> <td>ContiTech<br/>810 MB/O</td> </tr> <tr> <td>GOODYEAR<br/>1R14-868</td> </tr> </table>   | Competitor code                | Firestone<br>1T19L-7<br>W01-M58-7237    | ContiTech<br>810 MB/O   | GOODYEAR<br>1R14-868          | <p>Piston: No</p>    | <table border="1"> <thead> <tr> <th>Code</th> <th>Manufacturer</th> </tr> </thead> <tbody> <tr> <td> </td> <td> </td> </tr> </tbody> </table> |   | Code | Manufacturer |              |                |        |         |         |         |         |         |        |
| Competitor code   |                                |   |                         |                               |                      |   |   |      |              |              |                |        |         |         |         |         |         |        |
| Firestone<br>1T19L-7<br>W01-M58-7237  |                                |   |                         |                               |                      |   |   |      |              |              |                |        |         |         |         |         |         |        |
| ContiTech<br>810 MB/O   |                                |   |                         |                               |                      |   |   |      |              |              |                |        |         |         |         |         |         |        |
| GOODYEAR<br>1R14-868  |                                |   |                         |                               |                      |   |   |      |              |              |                |        |         |         |         |         |         |        |
| Code  | Manufacturer                   |   |                         |                               |                      |   |   |      |              |              |                |        |         |         |         |         |         |        |
|   |                                |   |                         |                               |                      |   |   |      |              |              |                |        |         |         |         |         |         |        |
| <b>FM18006.H02</b>  |                                |   |                         |                               |                      |   |   |      |              |              |                |        |         |         |         |         |         |        |
| <table border="1"> <tr> <td>Competitor code</td> </tr> <tr> <td>Firestone</td> </tr> <tr> <td>ContiTech</td> </tr> <tr> <td>GOODYEAR</td> </tr> </table>  | Competitor code                | Firestone                               | ContiTech               | GOODYEAR                      | <p>Piston: No</p>    | <table border="1"> <thead> <tr> <th>Code</th> <th>Manufacturer</th> </tr> </thead> <tbody> <tr> <td> </td> <td> </td> </tr> </tbody> </table> |   | Code | Manufacturer |              |                |        |         |         |         |         |         |        |
| Competitor code   |                                |   |                         |                               |                      |   |   |      |              |              |                |        |         |         |         |         |         |        |
| Firestone   |                                |   |                         |                               |                      |   |   |      |              |              |                |        |         |         |         |         |         |        |
| ContiTech   |                                |   |                         |                               |                      |   |   |      |              |              |                |        |         |         |         |         |         |        |
| GOODYEAR  |                                |   |                         |                               |                      |   |   |      |              |              |                |        |         |         |         |         |         |        |
| Code  | Manufacturer                   |   |                         |                               |                      |   |   |      |              |              |                |        |         |         |         |         |         |        |
|   |                                |   |                         |                               |                      |   |   |      |              |              |                |        |         |         |         |         |         |        |



# Towing vehicle & Trailer & Semitrailer Air Springs

| Code   | Section, Top View, Bottom View | Applications  |              |
|--|--------------------------------|---------------|--------------|
| <b>FM18006.H03</b>                             |                                |               |              |
| Competitor code                                |                                | Code          | Manufacturer |
| Firestone                                      |                                |               |              |
| ContiTech                                      |                                |               |              |
| GOODYEAR                                       |                                |               |              |
| Piston: No                                     |                                |               |              |
| <b>FM18006.C01A</b>                            |                                |               |              |
| Competitor code                                |                                | Code          | Manufacturer |
| Firestone<br>1T19LB8<br>W01-358-9141           |                                | 90557110      | SAF-HOLLAND  |
| GOODYEAR<br>1R14-215                           |                                |               |              |
|  |                                |               |              |
| Piston: Aluminum                               |                                |               |              |
| <b>FM18006.C06</b>                             |                                |               |              |
| Competitor code                                |                                | Code          | Manufacturer |
| Firestone<br>1T19L-7<br>W01-M58-6338           |                                | 2918V         | SAF-HOLLAND  |
| ContiTech<br>4810 N P05                        |                                | 3.229.0027.00 | SAF-HOLLAND  |
| VIBRACOUSTIC<br>V 1 D 28A-10<br>V 1 D 28A-1021 |                                | 3.229.2127.00 | SAF-HOLLAND  |
| GOODYEAR<br>1R14-730                           |                                | 3.229.2227.00 | SAF-HOLLAND  |
|  |                                | 1723275       | SCANIA       |
|  |                                | MLF7025       | MERITOR      |
|  |                                | CIMC          |              |
|  |                                | FUWA          |              |
|  |                                | LIANGSHAN     |              |
|  |                                | LUOXIANG      |              |
| Piston: Steel                                  |                                |               |              |





# Towing vehicle & Trailer & Semitrailer Air Springs

| Code   | Section, Top View, Bottom View | Applications |                       |
|--|--------------------------------|--------------|-----------------------|
| <b>FM18006.C10 (Customized Product)</b>                        |                                |              |                       |
| Competitor code  |                                | Code         | Manufacturer          |
| Firestone  |                                |              |                       |
| ContiTech  |                                |              |                       |
| FM810-A  |                                |              |                       |
| Piston: Steel  |                                |              |                       |
| <b>FM18006.C13</b>   |                                |              |                       |
| Competitor code  |                                | Code         | Manufacturer          |
| Firestone  |                                |              | CIMC                  |
| ContiTech  |                                |              | FUWA                  |
| 6338-A   |                                |              | LIANGSHAN<br>LUOXIANG |
| Piston: Steel  |                                |              |                       |
| <b>FM18007.H01</b>   |                                |              |                       |
| Competitor code  |                                | Code         | Manufacturer          |
| Firestone<br>1T19L-11<br>W01-M58-7238                          |                                |              |                       |
| ContiTech<br>813 MB/0  |                                |              |                       |
| VIBRACOUSTIC<br>V 1 D 28B-2 NP                                 |                                |              |                       |
| GOODYEAR<br>1R14-867   |                                |              |                       |
| W01-M58-6364/6339<br>Service assembly for<br>W01-M58-6364/6339 |                                |              |                       |
| Piston: No   |                                |              |                       |

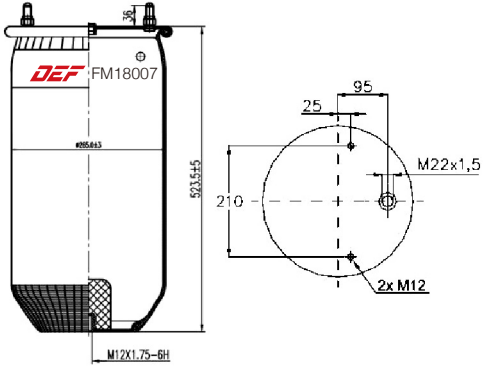
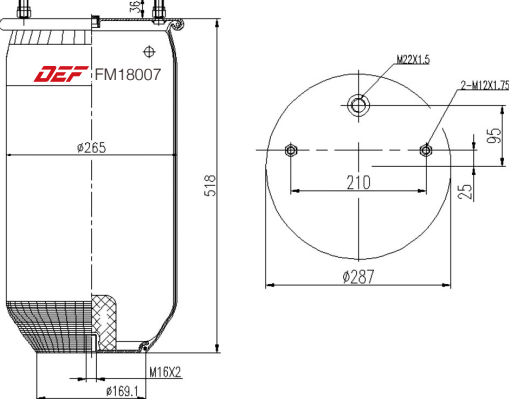

# Towing vehicle & Trailer & Semitrailer Air Springs

| Code  | Section, Top View, Bottom View | Applications                          |                         |                                 |                      |   |   |      |              |               |             |         |         |         |        |  |      |  |      |  |           |  |          |
|---|--------------------------------|---------------------------------------|-------------------------|---------------------------------|----------------------|---|---|------|--------------|---------------|-------------|---------|---------|---------|--------|--|------|--|------|--|-----------|--|----------|
| <b>FM18007.H02</b>  |                                |                                       |                         |                                 |                      |   |   |      |              |               |             |         |         |         |        |  |      |  |      |  |           |  |          |
| <table border="1"> <tr> <td>Competitor code</td> </tr> <tr> <td>Firestone<br/>1T19L-11<br/>W01-M58-6335</td> </tr> <tr> <td>ContiTech<br/>4023 N P06</td> </tr> <tr> <td>VIBRACOUSTIC<br/>V 1 D 28B-10 NP</td> </tr> <tr> <td>GOODYEAR<br/>1R14-729</td> </tr> </table> | Competitor code                | Firestone<br>1T19L-11<br>W01-M58-6335 | ContiTech<br>4023 N P06 | VIBRACOUSTIC<br>V 1 D 28B-10 NP | GOODYEAR<br>1R14-729 |  <p>Piston: No</p>   | <table border="1"> <thead> <tr> <th>Code</th> <th>Manufacturer</th> </tr> </thead> <tbody> <tr> <td>3.229.0031.00</td> <td>SAF-HOLLAND</td> </tr> <tr> <td>751 082</td> <td>SCHMITZ</td> </tr> <tr> <td>1723280</td> <td>SCANIA</td> </tr> <tr> <td></td> <td>CIMC</td> </tr> <tr> <td></td> <td>FUWA</td> </tr> <tr> <td></td> <td>LIANGSHAN</td> </tr> <tr> <td></td> <td>LUOXIANG</td> </tr> </tbody> </table> | Code | Manufacturer | 3.229.0031.00 | SAF-HOLLAND | 751 082 | SCHMITZ | 1723280 | SCANIA |  | CIMC |  | FUWA |  | LIANGSHAN |  | LUOXIANG |
| Competitor code   |                                |                                       |                         |                                 |                      |   |   |      |              |               |             |         |         |         |        |  |      |  |      |  |           |  |          |
| Firestone<br>1T19L-11<br>W01-M58-6335   |                                |                                       |                         |                                 |                      |   |   |      |              |               |             |         |         |         |        |  |      |  |      |  |           |  |          |
| ContiTech<br>4023 N P06   |                                |                                       |                         |                                 |                      |   |   |      |              |               |             |         |         |         |        |  |      |  |      |  |           |  |          |
| VIBRACOUSTIC<br>V 1 D 28B-10 NP   |                                |                                       |                         |                                 |                      |   |   |      |              |               |             |         |         |         |        |  |      |  |      |  |           |  |          |
| GOODYEAR<br>1R14-729  |                                |                                       |                         |                                 |                      |   |   |      |              |               |             |         |         |         |        |  |      |  |      |  |           |  |          |
| Code  | Manufacturer                   |                                       |                         |                                 |                      |   |   |      |              |               |             |         |         |         |        |  |      |  |      |  |           |  |          |
| 3.229.0031.00   | SAF-HOLLAND                    |                                       |                         |                                 |                      |   |   |      |              |               |             |         |         |         |        |  |      |  |      |  |           |  |          |
| 751 082   | SCHMITZ                        |                                       |                         |                                 |                      |   |   |      |              |               |             |         |         |         |        |  |      |  |      |  |           |  |          |
| 1723280   | SCANIA                         |                                       |                         |                                 |                      |   |   |      |              |               |             |         |         |         |        |  |      |  |      |  |           |  |          |
|   | CIMC                           |                                       |                         |                                 |                      |   |   |      |              |               |             |         |         |         |        |  |      |  |      |  |           |  |          |
|   | FUWA                           |                                       |                         |                                 |                      |   |   |      |              |               |             |         |         |         |        |  |      |  |      |  |           |  |          |
|   | LIANGSHAN                      |                                       |                         |                                 |                      |   |   |      |              |               |             |         |         |         |        |  |      |  |      |  |           |  |          |
|   | LUOXIANG                       |                                       |                         |                                 |                      |   |   |      |              |               |             |         |         |         |        |  |      |  |      |  |           |  |          |
| <b>FM18007.H03</b>  |                                |                                       |                         |                                 |                      |   |   |      |              |               |             |         |         |         |        |  |      |  |      |  |           |  |          |
| <table border="1"> <tr> <td>Competitor code</td> </tr> <tr> <td>Firestone<br/>1T19L-11<br/>W01-M58-6335</td> </tr> <tr> <td>ContiTech<br/>4023 N P06</td> </tr> <tr> <td>VIBRACOUSTIC<br/>V 1 D 28B-10 NP</td> </tr> <tr> <td>GOODYEAR<br/>1R14-729</td> </tr> </table> | Competitor code                | Firestone<br>1T19L-11<br>W01-M58-6335 | ContiTech<br>4023 N P06 | VIBRACOUSTIC<br>V 1 D 28B-10 NP | GOODYEAR<br>1R14-729 |  <p>Piston: No</p> | <table border="1"> <thead> <tr> <th>Code</th> <th>Manufacturer</th> </tr> </thead> <tbody> <tr> <td> </td> <td> </td> </tr> </tbody> </table>   | Code | Manufacturer |               |             |         |         |         |        |  |      |  |      |  |           |  |          |
| Competitor code   |                                |                                       |                         |                                 |                      |   |   |      |              |               |             |         |         |         |        |  |      |  |      |  |           |  |          |
| Firestone<br>1T19L-11<br>W01-M58-6335   |                                |                                       |                         |                                 |                      |   |   |      |              |               |             |         |         |         |        |  |      |  |      |  |           |  |          |
| ContiTech<br>4023 N P06   |                                |                                       |                         |                                 |                      |   |   |      |              |               |             |         |         |         |        |  |      |  |      |  |           |  |          |
| VIBRACOUSTIC<br>V 1 D 28B-10 NP   |                                |                                       |                         |                                 |                      |   |   |      |              |               |             |         |         |         |        |  |      |  |      |  |           |  |          |
| GOODYEAR<br>1R14-729  |                                |                                       |                         |                                 |                      |   |   |      |              |               |             |         |         |         |        |  |      |  |      |  |           |  |          |
| Code  | Manufacturer                   |                                       |                         |                                 |                      |   |   |      |              |               |             |         |         |         |        |  |      |  |      |  |           |  |          |
|   |                                |                                       |                         |                                 |                      |   |   |      |              |               |             |         |         |         |        |  |      |  |      |  |           |  |          |

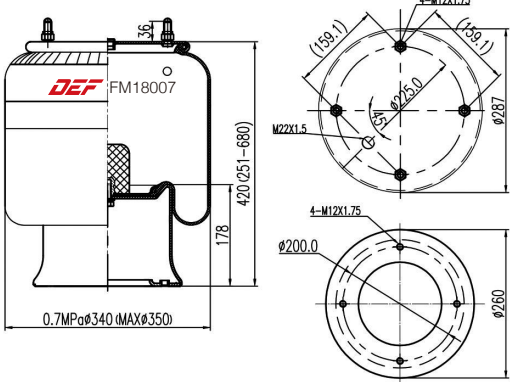
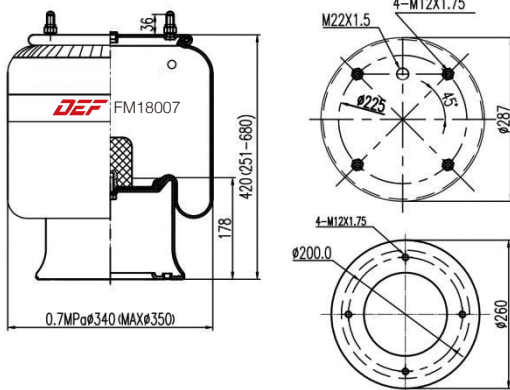

# Towing vehicle & Trailer & Semitrailer Air Springs

| Code   | Section, Top View, Bottom View | Applications  |                     |  |  |  |   |           |              |          |             |           |             |        |             |               |            |               |            |           |         |        |        |               |         |               |         |               |             |               |             |               |             |               |             |               |             |               |             |            |             |          |         |           |         |          |         |             |         |         |         |
|--|--------------------------------|---|---------------------|--|--|--|---|-----------|--------------|----------|-------------|-----------|-------------|--------|-------------|---------------|------------|---------------|------------|-----------|---------|--------|--------|---------------|---------|---------------|---------|---------------|-------------|---------------|-------------|---------------|-------------|---------------|-------------|---------------|-------------|---------------|-------------|------------|-------------|----------|---------|-----------|---------|----------|---------|-------------|---------|---------|---------|
| <b>FM18007.H02</b>   |                                |   |                     |  |  |  |   |           |              |          |             |           |             |        |             |               |            |               |            |           |         |        |        |               |         |               |         |               |             |               |             |               |             |               |             |               |             |               |             |            |             |          |         |           |         |          |         |             |         |         |         |
| <table border="1"> <tr> <td>Competitor code</td> </tr> <tr> <td>Firestone<br/>1T19L-11<br/>W01-M58-6364<br/>W01-M58-6339</td> </tr> <tr> <td>ContiTech<br/>813 MB</td> </tr> <tr> <td>VIBRACOUSTIC<br/>V 1 D 28B-2</td> </tr> <tr> <td>GOODYEAR<br/>1R14-857</td> </tr> </table> | Competitor code                | Firestone<br>1T19L-11<br>W01-M58-6364<br>W01-M58-6339 | ContiTech<br>813 MB | VIBRACOUSTIC<br>V 1 D 28B-2  | GOODYEAR<br>1R14-857   |  <p>Piston: Steel</p> | <table border="1"> <thead> <tr> <th>Code</th> <th>Manufacturer</th> </tr> </thead> <tbody> <tr><td>505859</td><td>HENDRICKSON</td></tr> <tr><td>505859-01</td><td>HENDRICKSON</td></tr> <tr><td>785170</td><td>HENDRICKSON</td></tr> <tr><td>4.731.030.000</td><td>KÄSSBOHRER</td></tr> <tr><td>4.731.033.000</td><td>KÄSSBOHRER</td></tr> <tr><td>2121 5633</td><td>MERITOR</td></tr> <tr><td>175005</td><td>PEGASO</td></tr> <tr><td>5,000,790,692</td><td>RENAULT</td></tr> <tr><td>5,010,130,925</td><td>RENAULT</td></tr> <tr><td>2.229.0003.00</td><td>SAF-HOLLAND</td></tr> <tr><td>2.229.2103.00</td><td>SAF-HOLLAND</td></tr> <tr><td>2.229.2203.00</td><td>SAF-HOLLAND</td></tr> <tr><td>2.229.2403.00</td><td>SAF-HOLLAND</td></tr> <tr><td>2.229.2603.00</td><td>SAF-HOLLAND</td></tr> <tr><td>3.228.0003.00</td><td>SAF-HOLLAND</td></tr> <tr><td>8403 / 102</td><td>SAF-HOLLAND</td></tr> <tr><td>US 07345</td><td>WEWELER</td></tr> <tr><td>US 07345F</td><td>WEWELER</td></tr> <tr><td>US 87408</td><td>WEWELER</td></tr> <tr><td>128 147 122</td><td>VIBERTI</td></tr> <tr><td>644 285</td><td>VIBERTI</td></tr> </tbody> </table> | Code      | Manufacturer | 505859   | HENDRICKSON | 505859-01 | HENDRICKSON | 785170 | HENDRICKSON | 4.731.030.000 | KÄSSBOHRER | 4.731.033.000 | KÄSSBOHRER | 2121 5633 | MERITOR | 175005 | PEGASO | 5,000,790,692 | RENAULT | 5,010,130,925 | RENAULT | 2.229.0003.00 | SAF-HOLLAND | 2.229.2103.00 | SAF-HOLLAND | 2.229.2203.00 | SAF-HOLLAND | 2.229.2403.00 | SAF-HOLLAND | 2.229.2603.00 | SAF-HOLLAND | 3.228.0003.00 | SAF-HOLLAND | 8403 / 102 | SAF-HOLLAND | US 07345 | WEWELER | US 07345F | WEWELER | US 87408 | WEWELER | 128 147 122 | VIBERTI | 644 285 | VIBERTI |
| Competitor code  |                                |   |                     |  |  |  |   |           |              |          |             |           |             |        |             |               |            |               |            |           |         |        |        |               |         |               |         |               |             |               |             |               |             |               |             |               |             |               |             |            |             |          |         |           |         |          |         |             |         |         |         |
| Firestone<br>1T19L-11<br>W01-M58-6364<br>W01-M58-6339  |                                |   |                     |  |  |  |   |           |              |          |             |           |             |        |             |               |            |               |            |           |         |        |        |               |         |               |         |               |             |               |             |               |             |               |             |               |             |               |             |            |             |          |         |           |         |          |         |             |         |         |         |
| ContiTech<br>813 MB  |                                |   |                     |  |  |  |   |           |              |          |             |           |             |        |             |               |            |               |            |           |         |        |        |               |         |               |         |               |             |               |             |               |             |               |             |               |             |               |             |            |             |          |         |           |         |          |         |             |         |         |         |
| VIBRACOUSTIC<br>V 1 D 28B-2  |                                |   |                     |  |  |  |   |           |              |          |             |           |             |        |             |               |            |               |            |           |         |        |        |               |         |               |         |               |             |               |             |               |             |               |             |               |             |               |             |            |             |          |         |           |         |          |         |             |         |         |         |
| GOODYEAR<br>1R14-857   |                                |   |                     |  |  |  |   |           |              |          |             |           |             |        |             |               |            |               |            |           |         |        |        |               |         |               |         |               |             |               |             |               |             |               |             |               |             |               |             |            |             |          |         |           |         |          |         |             |         |         |         |
| Code   | Manufacturer                   |   |                     |  |  |  |   |           |              |          |             |           |             |        |             |               |            |               |            |           |         |        |        |               |         |               |         |               |             |               |             |               |             |               |             |               |             |               |             |            |             |          |         |           |         |          |         |             |         |         |         |
| 505859   | HENDRICKSON                    |   |                     |  |  |  |   |           |              |          |             |           |             |        |             |               |            |               |            |           |         |        |        |               |         |               |         |               |             |               |             |               |             |               |             |               |             |               |             |            |             |          |         |           |         |          |         |             |         |         |         |
| 505859-01  | HENDRICKSON                    |   |                     |  |  |  |   |           |              |          |             |           |             |        |             |               |            |               |            |           |         |        |        |               |         |               |         |               |             |               |             |               |             |               |             |               |             |               |             |            |             |          |         |           |         |          |         |             |         |         |         |
| 785170   | HENDRICKSON                    |   |                     |  |  |  |   |           |              |          |             |           |             |        |             |               |            |               |            |           |         |        |        |               |         |               |         |               |             |               |             |               |             |               |             |               |             |               |             |            |             |          |         |           |         |          |         |             |         |         |         |
| 4.731.030.000  | KÄSSBOHRER                     |   |                     |  |  |  |   |           |              |          |             |           |             |        |             |               |            |               |            |           |         |        |        |               |         |               |         |               |             |               |             |               |             |               |             |               |             |               |             |            |             |          |         |           |         |          |         |             |         |         |         |
| 4.731.033.000  | KÄSSBOHRER                     |   |                     |  |  |  |   |           |              |          |             |           |             |        |             |               |            |               |            |           |         |        |        |               |         |               |         |               |             |               |             |               |             |               |             |               |             |               |             |            |             |          |         |           |         |          |         |             |         |         |         |
| 2121 5633  | MERITOR                        |   |                     |  |  |  |   |           |              |          |             |           |             |        |             |               |            |               |            |           |         |        |        |               |         |               |         |               |             |               |             |               |             |               |             |               |             |               |             |            |             |          |         |           |         |          |         |             |         |         |         |
| 175005   | PEGASO                         |   |                     |  |  |  |   |           |              |          |             |           |             |        |             |               |            |               |            |           |         |        |        |               |         |               |         |               |             |               |             |               |             |               |             |               |             |               |             |            |             |          |         |           |         |          |         |             |         |         |         |
| 5,000,790,692  | RENAULT                        |   |                     |  |  |  |   |           |              |          |             |           |             |        |             |               |            |               |            |           |         |        |        |               |         |               |         |               |             |               |             |               |             |               |             |               |             |               |             |            |             |          |         |           |         |          |         |             |         |         |         |
| 5,010,130,925  | RENAULT                        |   |                     |  |  |  |   |           |              |          |             |           |             |        |             |               |            |               |            |           |         |        |        |               |         |               |         |               |             |               |             |               |             |               |             |               |             |               |             |            |             |          |         |           |         |          |         |             |         |         |         |
| 2.229.0003.00  | SAF-HOLLAND                    |   |                     |  |  |  |   |           |              |          |             |           |             |        |             |               |            |               |            |           |         |        |        |               |         |               |         |               |             |               |             |               |             |               |             |               |             |               |             |            |             |          |         |           |         |          |         |             |         |         |         |
| 2.229.2103.00  | SAF-HOLLAND                    |   |                     |  |  |  |   |           |              |          |             |           |             |        |             |               |            |               |            |           |         |        |        |               |         |               |         |               |             |               |             |               |             |               |             |               |             |               |             |            |             |          |         |           |         |          |         |             |         |         |         |
| 2.229.2203.00  | SAF-HOLLAND                    |   |                     |  |  |  |   |           |              |          |             |           |             |        |             |               |            |               |            |           |         |        |        |               |         |               |         |               |             |               |             |               |             |               |             |               |             |               |             |            |             |          |         |           |         |          |         |             |         |         |         |
| 2.229.2403.00  | SAF-HOLLAND                    |   |                     |  |  |  |   |           |              |          |             |           |             |        |             |               |            |               |            |           |         |        |        |               |         |               |         |               |             |               |             |               |             |               |             |               |             |               |             |            |             |          |         |           |         |          |         |             |         |         |         |
| 2.229.2603.00  | SAF-HOLLAND                    |   |                     |  |  |  |   |           |              |          |             |           |             |        |             |               |            |               |            |           |         |        |        |               |         |               |         |               |             |               |             |               |             |               |             |               |             |               |             |            |             |          |         |           |         |          |         |             |         |         |         |
| 3.228.0003.00  | SAF-HOLLAND                    |   |                     |  |  |  |   |           |              |          |             |           |             |        |             |               |            |               |            |           |         |        |        |               |         |               |         |               |             |               |             |               |             |               |             |               |             |               |             |            |             |          |         |           |         |          |         |             |         |         |         |
| 8403 / 102   | SAF-HOLLAND                    |   |                     |  |  |  |   |           |              |          |             |           |             |        |             |               |            |               |            |           |         |        |        |               |         |               |         |               |             |               |             |               |             |               |             |               |             |               |             |            |             |          |         |           |         |          |         |             |         |         |         |
| US 07345   | WEWELER                        |   |                     |  |  |  |   |           |              |          |             |           |             |        |             |               |            |               |            |           |         |        |        |               |         |               |         |               |             |               |             |               |             |               |             |               |             |               |             |            |             |          |         |           |         |          |         |             |         |         |         |
| US 07345F  | WEWELER                        |   |                     |  |  |  |   |           |              |          |             |           |             |        |             |               |            |               |            |           |         |        |        |               |         |               |         |               |             |               |             |               |             |               |             |               |             |               |             |            |             |          |         |           |         |          |         |             |         |         |         |
| US 87408   | WEWELER                        |   |                     |  |  |  |   |           |              |          |             |           |             |        |             |               |            |               |            |           |         |        |        |               |         |               |         |               |             |               |             |               |             |               |             |               |             |               |             |            |             |          |         |           |         |          |         |             |         |         |         |
| 128 147 122  | VIBERTI                        |   |                     |  |  |  |   |           |              |          |             |           |             |        |             |               |            |               |            |           |         |        |        |               |         |               |         |               |             |               |             |               |             |               |             |               |             |               |             |            |             |          |         |           |         |          |         |             |         |         |         |
| 644 285  | VIBERTI                        |   |                     |  |  |  |   |           |              |          |             |           |             |        |             |               |            |               |            |           |         |        |        |               |         |               |         |               |             |               |             |               |             |               |             |               |             |               |             |            |             |          |         |           |         |          |         |             |         |         |         |
| <b>FM18007.H03</b>   |                                |   |                     |  |  |  |   |           |              |          |             |           |             |        |             |               |            |               |            |           |         |        |        |               |         |               |         |               |             |               |             |               |             |               |             |               |             |               |             |            |             |          |         |           |         |          |         |             |         |         |         |
| <table border="1"> <tr> <td>Competitor code</td> </tr> <tr> <td>Firestone<br/>1T19L-11<br/>W01-M58-7370</td> </tr> <tr> <td>ContiTech</td> </tr> </table>  | Competitor code                | Firestone<br>1T19L-11<br>W01-M58-7370                 | ContiTech           |  <p>Piston: Steel</p> | <table border="1"> <thead> <tr> <th>Code</th> <th>Manufacturer</th> </tr> </thead> <tbody> <tr><td>22.114.00</td><td>BATTAGLINO</td></tr> <tr><td>21222239</td><td>ROR MERITOR</td></tr> </tbody> </table> | Code   | Manufacturer  | 22.114.00 | BATTAGLINO   | 21222239 | ROR MERITOR |           |             |        |             |               |            |               |            |           |         |        |        |               |         |               |         |               |             |               |             |               |             |               |             |               |             |               |             |            |             |          |         |           |         |          |         |             |         |         |         |
| Competitor code  |                                |   |                     |  |  |  |   |           |              |          |             |           |             |        |             |               |            |               |            |           |         |        |        |               |         |               |         |               |             |               |             |               |             |               |             |               |             |               |             |            |             |          |         |           |         |          |         |             |         |         |         |
| Firestone<br>1T19L-11<br>W01-M58-7370  |                                |   |                     |  |  |  |   |           |              |          |             |           |             |        |             |               |            |               |            |           |         |        |        |               |         |               |         |               |             |               |             |               |             |               |             |               |             |               |             |            |             |          |         |           |         |          |         |             |         |         |         |
| ContiTech  |                                |   |                     |  |  |  |   |           |              |          |             |           |             |        |             |               |            |               |            |           |         |        |        |               |         |               |         |               |             |               |             |               |             |               |             |               |             |               |             |            |             |          |         |           |         |          |         |             |         |         |         |
| Code   | Manufacturer                   |   |                     |  |  |  |   |           |              |          |             |           |             |        |             |               |            |               |            |           |         |        |        |               |         |               |         |               |             |               |             |               |             |               |             |               |             |               |             |            |             |          |         |           |         |          |         |             |         |         |         |
| 22.114.00  | BATTAGLINO                     |   |                     |  |  |  |   |           |              |          |             |           |             |        |             |               |            |               |            |           |         |        |        |               |         |               |         |               |             |               |             |               |             |               |             |               |             |               |             |            |             |          |         |           |         |          |         |             |         |         |         |
| 21222239   | ROR MERITOR                    |   |                     |  |  |  |   |           |              |          |             |           |             |        |             |               |            |               |            |           |         |        |        |               |         |               |         |               |             |               |             |               |             |               |             |               |             |               |             |            |             |          |         |           |         |          |         |             |         |         |         |



# Towing vehicle & Trailer & Semitrailer Air Springs

| Code  | Section, Top View, Bottom View | Applications  |                         |                              |                      |                      |   |  |              |               |             |               |             |               |             |               |             |         |        |         |         |
|---|--------------------------------|---|-------------------------|------------------------------|----------------------|----------------------|---|--|--------------|---------------|-------------|---------------|-------------|---------------|-------------|---------------|-------------|---------|--------|---------|---------|
| <b>FM18007.C03</b>  |                                |   |                         |                              |                      |                      |   |  |              |               |             |               |             |               |             |               |             |         |        |         |         |
| <table border="1" style="width: 100%; border-collapse: collapse;"> <tr><td style="padding: 2px;">Competitor code</td></tr> <tr><td style="padding: 2px;">Firestone<br/>1T19L-11<br/>W01-M58-6348</td></tr> <tr><td style="padding: 2px;">ContiTech<br/>4023 N P03</td></tr> <tr><td style="padding: 2px;">VIBRACOUSTIC<br/>V 1 D 28B-10</td></tr> <tr><td style="padding: 2px;">GOODYEAR<br/>1R14-729</td></tr> </table>  | Competitor code                | Firestone<br>1T19L-11<br>W01-M58-6348                 | ContiTech<br>4023 N P03 | VIBRACOUSTIC<br>V 1 D 28B-10 | GOODYEAR<br>1R14-729 | <p>Piston: Steel</p> | <table border="1" style="width: 100%; border-collapse: collapse;"> <thead> <tr> <th style="width: 50%;">Code</th> <th style="width: 50%;">Manufacturer</th> </tr> </thead> <tbody> <tr><td>3.229.0031.00</td><td>SAF-HOLLAND</td></tr> <tr><td>3.229.2131.00</td><td>SAF-HOLLAND</td></tr> <tr><td>3.229.2231.00</td><td>SAF-HOLLAND</td></tr> <tr><td>3.229.2431.00</td><td>SAF-HOLLAND</td></tr> <tr><td>1723280</td><td>SCANIA</td></tr> <tr><td>751 082</td><td>SCHMITZ</td></tr> </tbody> </table> | Code   | Manufacturer | 3.229.0031.00 | SAF-HOLLAND | 3.229.2131.00 | SAF-HOLLAND | 3.229.2231.00 | SAF-HOLLAND | 3.229.2431.00 | SAF-HOLLAND | 1723280 | SCANIA | 751 082 | SCHMITZ |
| Competitor code   |                                |   |                         |                              |                      |                      |   |  |              |               |             |               |             |               |             |               |             |         |        |         |         |
| Firestone<br>1T19L-11<br>W01-M58-6348   |                                |   |                         |                              |                      |                      |   |  |              |               |             |               |             |               |             |               |             |         |        |         |         |
| ContiTech<br>4023 N P03   |                                |   |                         |                              |                      |                      |   |  |              |               |             |               |             |               |             |               |             |         |        |         |         |
| VIBRACOUSTIC<br>V 1 D 28B-10  |                                |   |                         |                              |                      |                      |   |  |              |               |             |               |             |               |             |               |             |         |        |         |         |
| GOODYEAR<br>1R14-729  |                                |   |                         |                              |                      |                      |   |  |              |               |             |               |             |               |             |               |             |         |        |         |         |
| Code  | Manufacturer                   |   |                         |                              |                      |                      |   |  |              |               |             |               |             |               |             |               |             |         |        |         |         |
| 3.229.0031.00   | SAF-HOLLAND                    |   |                         |                              |                      |                      |   |  |              |               |             |               |             |               |             |               |             |         |        |         |         |
| 3.229.2131.00   | SAF-HOLLAND                    |   |                         |                              |                      |                      |   |  |              |               |             |               |             |               |             |               |             |         |        |         |         |
| 3.229.2231.00   | SAF-HOLLAND                    |   |                         |                              |                      |                      |   |  |              |               |             |               |             |               |             |               |             |         |        |         |         |
| 3.229.2431.00   | SAF-HOLLAND                    |   |                         |                              |                      |                      |   |  |              |               |             |               |             |               |             |               |             |         |        |         |         |
| 1723280   | SCANIA                         |   |                         |                              |                      |                      |   |  |              |               |             |               |             |               |             |               |             |         |        |         |         |
| 751 082   | SCHMITZ                        |   |                         |                              |                      |                      |   |  |              |               |             |               |             |               |             |               |             |         |        |         |         |
| <b>FM18007.C04 (Customized Product)</b>   |                                |   |                         |                              |                      |                      |   |  |              |               |             |               |             |               |             |               |             |         |        |         |         |
| <table border="1" style="width: 100%; border-collapse: collapse;"> <tr><td style="padding: 2px;">Competitor code</td></tr> <tr><td style="padding: 2px;">Firestone</td></tr> <tr><td style="padding: 2px;">ContiTech</td></tr> <tr><td style="padding: 2px;">VIBRACOUSTIC</td></tr> <tr><td style="padding: 2px;">GOODYEAR</td></tr> <tr><td style="padding: 2px;">6348-A</td></tr> </table>  | Competitor code                | Firestone   | ContiTech               | VIBRACOUSTIC                 | GOODYEAR             | 6348-A               | <p>Piston: Steel</p>  | <table border="1" style="width: 100%; border-collapse: collapse;"> <thead> <tr> <th style="width: 50%;">Code</th> <th style="width: 50%;">Manufacturer</th> </tr> </thead> <tbody> <tr><td> </td><td> </td></tr> </tbody> </table> | Code         | Manufacturer  |             |               |             |               |             |               |             |         |        |         |         |
| Competitor code   |                                |   |                         |                              |                      |                      |   |  |              |               |             |               |             |               |             |               |             |         |        |         |         |
| Firestone   |                                |   |                         |                              |                      |                      |   |  |              |               |             |               |             |               |             |               |             |         |        |         |         |
| ContiTech   |                                |   |                         |                              |                      |                      |   |  |              |               |             |               |             |               |             |               |             |         |        |         |         |
| VIBRACOUSTIC  |                                |   |                         |                              |                      |                      |   |  |              |               |             |               |             |               |             |               |             |         |        |         |         |
| GOODYEAR  |                                |   |                         |                              |                      |                      |   |  |              |               |             |               |             |               |             |               |             |         |        |         |         |
| 6348-A  |                                |   |                         |                              |                      |                      |   |  |              |               |             |               |             |               |             |               |             |         |        |         |         |
| Code  | Manufacturer                   |   |                         |                              |                      |                      |   |  |              |               |             |               |             |               |             |               |             |         |        |         |         |
|   |                                |   |                         |                              |                      |                      |   |  |              |               |             |               |             |               |             |               |             |         |        |         |         |
| <b>FM18007.C05P (Customized Product)</b>  |                                |   |                         |                              |                      |                      |   |  |              |               |             |               |             |               |             |               |             |         |        |         |         |
| <table border="1" style="width: 100%; border-collapse: collapse;"> <tr><td style="padding: 2px;">Competitor code</td></tr> <tr><td style="padding: 2px;">Firestone<br/>1T19L-11<br/>W01-M58-6364<br/>W01-M58-6339</td></tr> <tr><td style="padding: 2px;">ContiTech<br/>813 MB</td></tr> <tr><td style="padding: 2px;">VIBRACOUSTIC<br/>V 1 D 28B-2</td></tr> <tr><td style="padding: 2px;">GOODYEAR<br/>1R14-857</td></tr> <tr><td style="padding: 2px;">6364</td></tr> </table> | Competitor code                | Firestone<br>1T19L-11<br>W01-M58-6364<br>W01-M58-6339 | ContiTech<br>813 MB     | VIBRACOUSTIC<br>V 1 D 28B-2  | GOODYEAR<br>1R14-857 | 6364                 | <p>Piston: Composite</p>  | <table border="1" style="width: 100%; border-collapse: collapse;"> <thead> <tr> <th style="width: 50%;">Code</th> <th style="width: 50%;">Manufacturer</th> </tr> </thead> <tbody> <tr><td> </td><td> </td></tr> </tbody> </table> | Code         | Manufacturer  |             |               |             |               |             |               |             |         |        |         |         |
| Competitor code   |                                |   |                         |                              |                      |                      |   |  |              |               |             |               |             |               |             |               |             |         |        |         |         |
| Firestone<br>1T19L-11<br>W01-M58-6364<br>W01-M58-6339   |                                |   |                         |                              |                      |                      |   |  |              |               |             |               |             |               |             |               |             |         |        |         |         |
| ContiTech<br>813 MB   |                                |   |                         |                              |                      |                      |   |  |              |               |             |               |             |               |             |               |             |         |        |         |         |
| VIBRACOUSTIC<br>V 1 D 28B-2   |                                |   |                         |                              |                      |                      |   |  |              |               |             |               |             |               |             |               |             |         |        |         |         |
| GOODYEAR<br>1R14-857  |                                |   |                         |                              |                      |                      |   |  |              |               |             |               |             |               |             |               |             |         |        |         |         |
| 6364  |                                |   |                         |                              |                      |                      |   |  |              |               |             |               |             |               |             |               |             |         |        |         |         |
| Code  | Manufacturer                   |   |                         |                              |                      |                      |   |  |              |               |             |               |             |               |             |               |             |         |        |         |         |
|   |                                |   |                         |                              |                      |                      |   |  |              |               |             |               |             |               |             |               |             |         |        |         |         |



# Towing vehicle & Trailer & Semitrailer Air Springs

| Code   | Section, Top View, Bottom View | Applications              |           |                      |   |      |              |  |      |  |      |  |          |
|--|--------------------------------|---------------------------|-----------|----------------------|---|------|--------------|--|------|--|------|--|----------|
| <b>FM18010.H01</b>   |                                |                           |           |                      |   |      |              |  |      |  |      |  |          |
| <table border="1"> <tr> <td>Competitor code</td> </tr> <tr> <td>Firestone</td> </tr> <tr> <td>ContiTech</td> </tr> </table>                  | Competitor code                | Firestone                 | ContiTech | <p>Piston: No</p>    | <table border="1"> <tr> <th>Code</th> <th>Manufacturer</th> </tr> <tr> <td></td> <td>CIMC</td> </tr> <tr> <td></td> <td>FUWA</td> </tr> <tr> <td></td> <td>LUOXIANG</td> </tr> </table> | Code | Manufacturer |  | CIMC |  | FUWA |  | LUOXIANG |
| Competitor code  |                                |                           |           |                      |   |      |              |  |      |  |      |  |          |
| Firestone  |                                |                           |           |                      |   |      |              |  |      |  |      |  |          |
| ContiTech  |                                |                           |           |                      |   |      |              |  |      |  |      |  |          |
| Code   | Manufacturer                   |                           |           |                      |   |      |              |  |      |  |      |  |          |
|  | CIMC                           |                           |           |                      |   |      |              |  |      |  |      |  |          |
|  | FUWA                           |                           |           |                      |   |      |              |  |      |  |      |  |          |
|  | LUOXIANG                       |                           |           |                      |   |      |              |  |      |  |      |  |          |
| <b>FM18010.C01</b>   |                                |                           |           |                      |   |      |              |  |      |  |      |  |          |
| <table border="1"> <tr> <td>Competitor code</td> </tr> <tr> <td>Firestone<br/>W01-M58-8105</td> </tr> <tr> <td>ContiTech</td> </tr> </table> | Competitor code                | Firestone<br>W01-M58-8105 | ContiTech | <p>Piston: Steel</p> | <table border="1"> <tr> <th>Code</th> <th>Manufacturer</th> </tr> <tr> <td></td> <td>CIMC</td> </tr> <tr> <td></td> <td>FUWA</td> </tr> <tr> <td></td> <td>LUOXIANG</td> </tr> </table> | Code | Manufacturer |  | CIMC |  | FUWA |  | LUOXIANG |
| Competitor code  |                                |                           |           |                      |   |      |              |  |      |  |      |  |          |
| Firestone<br>W01-M58-8105  |                                |                           |           |                      |   |      |              |  |      |  |      |  |          |
| ContiTech  |                                |                           |           |                      |   |      |              |  |      |  |      |  |          |
| Code   | Manufacturer                   |                           |           |                      |   |      |              |  |      |  |      |  |          |
|  | CIMC                           |                           |           |                      |   |      |              |  |      |  |      |  |          |
|  | FUWA                           |                           |           |                      |   |      |              |  |      |  |      |  |          |
|  | LUOXIANG                       |                           |           |                      |   |      |              |  |      |  |      |  |          |
| <b>FM18010.C02</b>   |                                |                           |           |                      |   |      |              |  |      |  |      |  |          |
| <table border="1"> <tr> <td>Competitor code</td> </tr> <tr> <td>Firestone<br/>W01-M58-8104</td> </tr> <tr> <td>ContiTech</td> </tr> </table> | Competitor code                | Firestone<br>W01-M58-8104 | ContiTech | <p>Piston: Steel</p> | <table border="1"> <tr> <th>Code</th> <th>Manufacturer</th> </tr> <tr> <td></td> <td>CIMC</td> </tr> <tr> <td></td> <td>FUWA</td> </tr> <tr> <td></td> <td>LUOXIANG</td> </tr> </table> | Code | Manufacturer |  | CIMC |  | FUWA |  | LUOXIANG |
| Competitor code  |                                |                           |           |                      |   |      |              |  |      |  |      |  |          |
| Firestone<br>W01-M58-8104  |                                |                           |           |                      |   |      |              |  |      |  |      |  |          |
| ContiTech  |                                |                           |           |                      |   |      |              |  |      |  |      |  |          |
| Code   | Manufacturer                   |                           |           |                      |   |      |              |  |      |  |      |  |          |
|  | CIMC                           |                           |           |                      |   |      |              |  |      |  |      |  |          |
|  | FUWA                           |                           |           |                      |   |      |              |  |      |  |      |  |          |
|  | LUOXIANG                       |                           |           |                      |   |      |              |  |      |  |      |  |          |

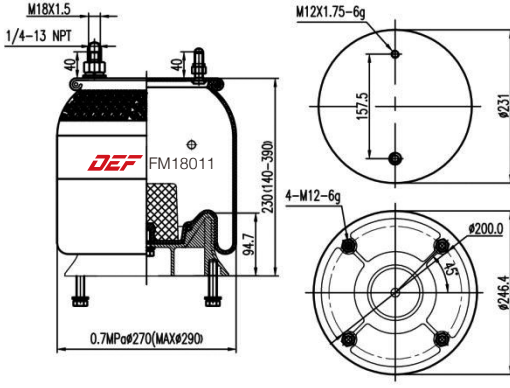
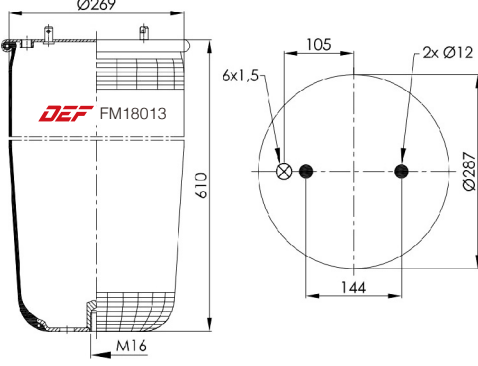
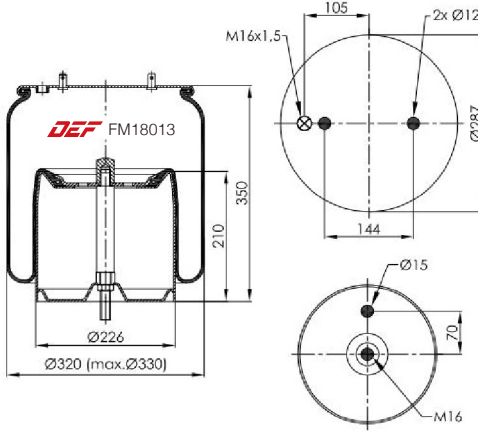

# Towing vehicle & Trailer & Semitrailer Air Springs

| Code  | Section, Top View, Bottom View | Applications   |                         |   |  |  |  |      |              |         |               |           |          |             |       |  |        |
|---|--------------------------------|--|-------------------------|---|--|--|--|------|--------------|---------|---------------|-----------|----------|-------------|-------|--|--------|
| <b>FM18011.C01A</b>   |                                |  |                         |   |  |  |  |      |              |         |               |           |          |             |       |  |        |
| <table border="1" style="width: 100%; border-collapse: collapse;"> <tr> <td style="padding: 5px;">Competitor code</td> </tr> <tr> <td style="padding: 5px;">Firestone<br/>1T15M-2<br/>W01-358-8646</td> </tr> <tr> <td style="padding: 5px;">ContiTech</td> </tr> </table>  | Competitor code                | Firestone<br>1T15M-2<br>W01-358-8646                   | ContiTech               |  <p style="text-align: center;">Piston: Aluminum</p> | <table border="1" style="width: 100%; border-collapse: collapse;"> <thead> <tr> <th style="width: 30%;">Code</th> <th style="width: 70%;">Manufacturer</th> </tr> </thead> <tbody> <tr> <td></td> <td>ANKAI</td> </tr> <tr> <td></td> <td>ZHONGTONG BUS</td> </tr> <tr> <td>229002271</td> <td>KINGLONG</td> </tr> <tr> <td>29V55-03520</td> <td>HIGER</td> </tr> <tr> <td></td> <td>YUTONG</td> </tr> </tbody> </table> | Code   | Manufacturer   |      | ANKAI        |         | ZHONGTONG BUS | 229002271 | KINGLONG | 29V55-03520 | HIGER |  | YUTONG |
| Competitor code   |                                |  |                         |   |  |  |  |      |              |         |               |           |          |             |       |  |        |
| Firestone<br>1T15M-2<br>W01-358-8646  |                                |  |                         |   |  |  |  |      |              |         |               |           |          |             |       |  |        |
| ContiTech   |                                |  |                         |   |  |  |  |      |              |         |               |           |          |             |       |  |        |
| Code  | Manufacturer                   |  |                         |   |  |  |  |      |              |         |               |           |          |             |       |  |        |
|   | ANKAI                          |  |                         |   |  |  |  |      |              |         |               |           |          |             |       |  |        |
|   | ZHONGTONG BUS                  |  |                         |   |  |  |  |      |              |         |               |           |          |             |       |  |        |
| 229002271   | KINGLONG                       |  |                         |   |  |  |  |      |              |         |               |           |          |             |       |  |        |
| 29V55-03520   | HIGER                          |  |                         |   |  |  |  |      |              |         |               |           |          |             |       |  |        |
|   | YUTONG                         |  |                         |   |  |  |  |      |              |         |               |           |          |             |       |  |        |
| <b>FM18013.H01</b>  |                                |  |                         |   |  |  |  |      |              |         |               |           |          |             |       |  |        |
| <table border="1" style="width: 100%; border-collapse: collapse;"> <tr> <td style="padding: 5px;">Competitor code</td> </tr> <tr> <td style="padding: 5px;">Firestone<br/>1T19 F-14<br/>W01-095-0365</td> </tr> <tr> <td style="padding: 5px;">ContiTech<br/>4913 N P04</td> </tr> <tr> <td style="padding: 5px;">GOODYEAR<br/>1R14-755</td> </tr> <tr> <td style="padding: 5px;">VIBRACOUSTIC<br/>V 1 D 28 H-16 NP</td> </tr> </table>               | Competitor code                | Firestone<br>1T19 F-14<br>W01-095-0365                 | ContiTech<br>4913 N P04 | GOODYEAR<br>1R14-755  | VIBRACOUSTIC<br>V 1 D 28 H-16 NP   |  <p style="text-align: center;">Piston: No</p>     | <table border="1" style="width: 100%; border-collapse: collapse;"> <thead> <tr> <th style="width: 30%;">Code</th> <th style="width: 70%;">Manufacturer</th> </tr> </thead> <tbody> <tr> <td>1379393</td> <td>SCANIA</td> </tr> </tbody> </table>   | Code | Manufacturer | 1379393 | SCANIA        |           |          |             |       |  |        |
| Competitor code   |                                |  |                         |   |  |  |  |      |              |         |               |           |          |             |       |  |        |
| Firestone<br>1T19 F-14<br>W01-095-0365  |                                |  |                         |   |  |  |  |      |              |         |               |           |          |             |       |  |        |
| ContiTech<br>4913 N P04   |                                |  |                         |   |  |  |  |      |              |         |               |           |          |             |       |  |        |
| GOODYEAR<br>1R14-755  |                                |  |                         |   |  |  |  |      |              |         |               |           |          |             |       |  |        |
| VIBRACOUSTIC<br>V 1 D 28 H-16 NP  |                                |  |                         |   |  |  |  |      |              |         |               |           |          |             |       |  |        |
| Code  | Manufacturer                   |  |                         |   |  |  |  |      |              |         |               |           |          |             |       |  |        |
| 1379393   | SCANIA                         |  |                         |   |  |  |  |      |              |         |               |           |          |             |       |  |        |
| <b>FM18013.C01</b>  |                                |  |                         |   |  |  |  |      |              |         |               |           |          |             |       |  |        |
| <table border="1" style="width: 100%; border-collapse: collapse;"> <tr> <td style="padding: 5px;">Competitor code</td> </tr> <tr> <td style="padding: 5px;">Firestone<br/>1T19 L-14<br/>W01-M58-9881<br/>W01-095-0500</td> </tr> <tr> <td style="padding: 5px;">ContiTech<br/>4913 N P02</td> </tr> <tr> <td style="padding: 5px;">GOODYEAR<br/>1R14-753</td> </tr> <tr> <td style="padding: 5px;">VIBRACOUSTIC<br/>V 1 D 28 H-16</td> </tr> </table> | Competitor code                | Firestone<br>1T19 L-14<br>W01-M58-9881<br>W01-095-0500 | ContiTech<br>4913 N P02 | GOODYEAR<br>1R14-753  | VIBRACOUSTIC<br>V 1 D 28 H-16  |  <p style="text-align: center;">Piston: Steel</p> | <table border="1" style="width: 100%; border-collapse: collapse;"> <thead> <tr> <th style="width: 30%;">Code</th> <th style="width: 70%;">Manufacturer</th> </tr> </thead> <tbody> <tr> <td>1379392</td> <td>SCANIA</td> </tr> <tr> <td>1440294</td> <td>SCANIA</td> </tr> </tbody> </table> | Code | Manufacturer | 1379392 | SCANIA        | 1440294   | SCANIA   |             |       |  |        |
| Competitor code   |                                |  |                         |   |  |  |  |      |              |         |               |           |          |             |       |  |        |
| Firestone<br>1T19 L-14<br>W01-M58-9881<br>W01-095-0500  |                                |  |                         |   |  |  |  |      |              |         |               |           |          |             |       |  |        |
| ContiTech<br>4913 N P02   |                                |  |                         |   |  |  |  |      |              |         |               |           |          |             |       |  |        |
| GOODYEAR<br>1R14-753  |                                |  |                         |   |  |  |  |      |              |         |               |           |          |             |       |  |        |
| VIBRACOUSTIC<br>V 1 D 28 H-16   |                                |  |                         |   |  |  |  |      |              |         |               |           |          |             |       |  |        |
| Code  | Manufacturer                   |  |                         |   |  |  |  |      |              |         |               |           |          |             |       |  |        |
| 1379392   | SCANIA                         |  |                         |   |  |  |  |      |              |         |               |           |          |             |       |  |        |
| 1440294   | SCANIA                         |  |                         |   |  |  |  |      |              |         |               |           |          |             |       |  |        |



# Towing vehicle & Trailer & Semitrailer Air Springs

| Code   | Section, Top View, Bottom View | Applications                           |                             |                      |                         |   |  |  |              |              |              |                                  |             |                 |         |          |       |          |     |         |       |        |               |                       |                       |
|--|--------------------------------|--|-----------------------------|----------------------|-------------------------|---|--|--|--------------|--------------|--------------|----------------------------------|-------------|-----------------|---------|----------|-------|----------|-----|---------|-------|--------|---------------|-----------------------|-----------------------|
| <b>FM18013.C01</b>   |                                |  |                             |                      |                         |   |  |  |              |              |              |                                  |             |                 |         |          |       |          |     |         |       |        |               |                       |                       |
| <table border="1"> <tr><td>Competitor code</td></tr> <tr><td>Firestone<br/>1T19 L-14<br/>W01-M58-3608</td></tr> <tr><td>ContiTech</td></tr> <tr><td>GOODYEAR</td></tr> <tr><td>VIBRACOUSTIC</td></tr> </table>   | Competitor code                | Firestone<br>1T19 L-14<br>W01-M58-3608 | ContiTech                   | GOODYEAR             | VIBRACOUSTIC            | <p>Piston: Steel</p>  | <table border="1"> <tr> <th data-bbox="956 422 1177 482">Code</th> <th data-bbox="1182 422 1425 482">Manufacturer</th> </tr> <tr> <td> </td> <td> </td> </tr> </table> |  | Code         | Manufacturer |              |                                  |             |                 |         |          |       |          |     |         |       |        |               |                       |                       |
| Competitor code  |                                |  |                             |                      |                         |   |  |  |              |              |              |                                  |             |                 |         |          |       |          |     |         |       |        |               |                       |                       |
| Firestone<br>1T19 L-14<br>W01-M58-3608   |                                |  |                             |                      |                         |   |  |  |              |              |              |                                  |             |                 |         |          |       |          |     |         |       |        |               |                       |                       |
| ContiTech  |                                |  |                             |                      |                         |   |  |  |              |              |              |                                  |             |                 |         |          |       |          |     |         |       |        |               |                       |                       |
| GOODYEAR   |                                |  |                             |                      |                         |   |  |  |              |              |              |                                  |             |                 |         |          |       |          |     |         |       |        |               |                       |                       |
| VIBRACOUSTIC   |                                |  |                             |                      |                         |   |  |  |              |              |              |                                  |             |                 |         |          |       |          |     |         |       |        |               |                       |                       |
| Code   | Manufacturer                   |  |                             |                      |                         |   |  |  |              |              |              |                                  |             |                 |         |          |       |          |     |         |       |        |               |                       |                       |
|  |                                |  |                             |                      |                         |   |  |  |              |              |              |                                  |             |                 |         |          |       |          |     |         |       |        |               |                       |                       |
| <b>FM18014.H01</b>   |                                |  |                             |                      |                         |   |  |  |              |              |              |                                  |             |                 |         |          |       |          |     |         |       |        |               |                       |                       |
| <table border="1"> <tr><td>Competitor code</td></tr> <tr><td>Firestone</td></tr> <tr><td>ContiTech</td></tr> <tr><td>GOODYEAR</td></tr> <tr><td>VIBRACOUSTIC</td></tr> <tr><td>W01-358-8050/8058/8460<br/>Service assembly for<br/>W01-358-8050/8058/8460</td></tr> </table> | Competitor code                | Firestone                              | ContiTech                   | GOODYEAR             | VIBRACOUSTIC            | W01-358-8050/8058/8460<br>Service assembly for<br>W01-358-8050/8058/8460  | <p>Piston: No</p>  | <table border="1"> <tr> <th data-bbox="956 957 1177 1017">Code</th> <th data-bbox="1182 957 1425 1017">Manufacturer</th> </tr> <tr> <td> </td> <td> </td> </tr> </table> |              | Code         | Manufacturer |                                  |             |                 |         |          |       |          |     |         |       |        |               |                       |                       |
| Competitor code  |                                |  |                             |                      |                         |   |  |  |              |              |              |                                  |             |                 |         |          |       |          |     |         |       |        |               |                       |                       |
| Firestone  |                                |  |                             |                      |                         |   |  |  |              |              |              |                                  |             |                 |         |          |       |          |     |         |       |        |               |                       |                       |
| ContiTech  |                                |  |                             |                      |                         |   |  |  |              |              |              |                                  |             |                 |         |          |       |          |     |         |       |        |               |                       |                       |
| GOODYEAR   |                                |  |                             |                      |                         |   |  |  |              |              |              |                                  |             |                 |         |          |       |          |     |         |       |        |               |                       |                       |
| VIBRACOUSTIC   |                                |  |                             |                      |                         |   |  |  |              |              |              |                                  |             |                 |         |          |       |          |     |         |       |        |               |                       |                       |
| W01-358-8050/8058/8460<br>Service assembly for<br>W01-358-8050/8058/8460   |                                |  |                             |                      |                         |   |  |  |              |              |              |                                  |             |                 |         |          |       |          |     |         |       |        |               |                       |                       |
| Code   | Manufacturer                   |  |                             |                      |                         |   |  |  |              |              |              |                                  |             |                 |         |          |       |          |     |         |       |        |               |                       |                       |
|  |                                |  |                             |                      |                         |   |  |  |              |              |              |                                  |             |                 |         |          |       |          |     |         |       |        |               |                       |                       |
| <b>FM18014.C01A</b>  |                                |  |                             |                      |                         |   |  |  |              |              |              |                                  |             |                 |         |          |       |          |     |         |       |        |               |                       |                       |
| <table border="1"> <tr><td>Competitor code</td></tr> <tr><td>Firestone<br/>1T19ZK5.7<br/>W01-358-8050</td></tr> <tr><td>ContiTech<br/>1110.5C-16A320</td></tr> <tr><td>GOODYEAR<br/>1R14-039</td></tr> </table>  | Competitor code                | Firestone<br>1T19ZK5.7<br>W01-358-8050 | ContiTech<br>1110.5C-16A320 | GOODYEAR<br>1R14-039 | <p>Piston: Aluminum</p> | <table border="1"> <tr> <th data-bbox="956 1517 1177 1548">Code</th> <th data-bbox="1182 1517 1425 1548">Manufacturer</th> </tr> <tr> <td>3528050</td> <td>DAYTON</td> </tr> <tr> <td>B-12514-013<br/>S4771<br/>36514-13</td> <td>HENDRICKSON</td> </tr> <tr> <td>S6002<br/>201680</td> <td>MERITOR</td> </tr> <tr> <td>23631-01</td> <td>REYCO</td> </tr> <tr> <td>57008050</td> <td>SAF</td> </tr> <tr> <td>3130498</td> <td>VOLVO</td> </tr> <tr> <td>AS0039</td> <td>WATSON-CHALIN</td> </tr> <tr> <td>1685174C1<br/>1R14-241</td> <td>NAVISTAR<br/>FLEETRITE</td> </tr> </table> |  | Code   | Manufacturer | 3528050      | DAYTON       | B-12514-013<br>S4771<br>36514-13 | HENDRICKSON | S6002<br>201680 | MERITOR | 23631-01 | REYCO | 57008050 | SAF | 3130498 | VOLVO | AS0039 | WATSON-CHALIN | 1685174C1<br>1R14-241 | NAVISTAR<br>FLEETRITE |
| Competitor code  |                                |  |                             |                      |                         |   |  |  |              |              |              |                                  |             |                 |         |          |       |          |     |         |       |        |               |                       |                       |
| Firestone<br>1T19ZK5.7<br>W01-358-8050   |                                |  |                             |                      |                         |   |  |  |              |              |              |                                  |             |                 |         |          |       |          |     |         |       |        |               |                       |                       |
| ContiTech<br>1110.5C-16A320  |                                |  |                             |                      |                         |   |  |  |              |              |              |                                  |             |                 |         |          |       |          |     |         |       |        |               |                       |                       |
| GOODYEAR<br>1R14-039   |                                |  |                             |                      |                         |   |  |  |              |              |              |                                  |             |                 |         |          |       |          |     |         |       |        |               |                       |                       |
| Code   | Manufacturer                   |  |                             |                      |                         |   |  |  |              |              |              |                                  |             |                 |         |          |       |          |     |         |       |        |               |                       |                       |
| 3528050  | DAYTON                         |  |                             |                      |                         |   |  |  |              |              |              |                                  |             |                 |         |          |       |          |     |         |       |        |               |                       |                       |
| B-12514-013<br>S4771<br>36514-13   | HENDRICKSON                    |  |                             |                      |                         |   |  |  |              |              |              |                                  |             |                 |         |          |       |          |     |         |       |        |               |                       |                       |
| S6002<br>201680  | MERITOR                        |  |                             |                      |                         |   |  |  |              |              |              |                                  |             |                 |         |          |       |          |     |         |       |        |               |                       |                       |
| 23631-01   | REYCO                          |  |                             |                      |                         |   |  |  |              |              |              |                                  |             |                 |         |          |       |          |     |         |       |        |               |                       |                       |
| 57008050   | SAF                            |  |                             |                      |                         |   |  |  |              |              |              |                                  |             |                 |         |          |       |          |     |         |       |        |               |                       |                       |
| 3130498  | VOLVO                          |  |                             |                      |                         |   |  |  |              |              |              |                                  |             |                 |         |          |       |          |     |         |       |        |               |                       |                       |
| AS0039   | WATSON-CHALIN                  |  |                             |                      |                         |   |  |  |              |              |              |                                  |             |                 |         |          |       |          |     |         |       |        |               |                       |                       |
| 1685174C1<br>1R14-241  | NAVISTAR<br>FLEETRITE          |  |                             |                      |                         |   |  |  |              |              |              |                                  |             |                 |         |          |       |          |     |         |       |        |               |                       |                       |



# Towing vehicle & Trailer & Semitrailer Air Springs

| Code  | Section, Top View, Bottom View | Applications                              |                             |                      |                         |   |   |      |              |               |                  |             |             |       |          |       |         |        |       |          |          |     |         |       |        |               |           |                       |          |
|---|--------------------------------|---|-----------------------------|----------------------|-------------------------|---|---|------|--------------|---------------|------------------|-------------|-------------|-------|----------|-------|---------|--------|-------|----------|----------|-----|---------|-------|--------|---------------|-----------|-----------------------|----------|
| <b>FM18014.C02</b>  |                                |   |                             |                      |                         |   |   |      |              |               |                  |             |             |       |          |       |         |        |       |          |          |     |         |       |        |               |           |                       |          |
| <table border="1"> <tr> <td data-bbox="153 411 381 491">Competitor code</td> </tr> <tr> <td data-bbox="153 491 381 592">Firestone<br/>W01-358-8050<br/>W01-358-8058</td> </tr> <tr> <td data-bbox="153 592 381 672">ContiTech</td> </tr> <tr> <td data-bbox="153 672 381 745">GOODYEAR</td> </tr> </table>                                      | Competitor code                | Firestone<br>W01-358-8050<br>W01-358-8058 | ContiTech                   | GOODYEAR             | <p>Piston: Steel</p>    | <table border="1"> <thead> <tr> <th data-bbox="951 411 1182 454">Code</th> <th data-bbox="1187 411 1436 454">Manufacturer</th> </tr> </thead> <tbody> <tr> <td data-bbox="951 454 1182 487">3528050</td> <td data-bbox="1187 454 1436 487">DAYTON</td> </tr> <tr> <td data-bbox="951 487 1182 519">B-12514-013</td> <td data-bbox="1187 487 1436 519" rowspan="3">HENDRICKSON</td> </tr> <tr> <td data-bbox="951 519 1182 551">S4771</td> </tr> <tr> <td data-bbox="951 551 1182 584">36514-13</td> </tr> <tr> <td data-bbox="951 584 1182 616">S6002</td> <td data-bbox="1187 584 1436 616">MERITOR</td> </tr> <tr> <td data-bbox="951 616 1182 648">201680</td> <td data-bbox="1187 616 1436 648" rowspan="2">REYCO</td> </tr> <tr> <td data-bbox="951 648 1182 681">23631-01</td> </tr> <tr> <td data-bbox="951 681 1182 713">57008050</td> <td data-bbox="1187 681 1436 713">SAF</td> </tr> <tr> <td data-bbox="951 713 1182 745">3130498</td> <td data-bbox="1187 713 1436 745">VOLVO</td> </tr> <tr> <td data-bbox="951 745 1182 778">AS0039</td> <td data-bbox="1187 745 1436 778">WATSON-CHALIN</td> </tr> <tr> <td data-bbox="951 778 1182 810">1685174C1</td> <td data-bbox="1187 778 1436 810" rowspan="2">NAVISTAR<br/>FLEETRITE</td> </tr> <tr> <td data-bbox="951 810 1182 832">1R14-241</td> </tr> </tbody> </table> |   | Code | Manufacturer | 3528050       | DAYTON           | B-12514-013 | HENDRICKSON | S4771 | 36514-13 | S6002 | MERITOR | 201680 | REYCO | 23631-01 | 57008050 | SAF | 3130498 | VOLVO | AS0039 | WATSON-CHALIN | 1685174C1 | NAVISTAR<br>FLEETRITE | 1R14-241 |
| Competitor code   |                                |   |                             |                      |                         |   |   |      |              |               |                  |             |             |       |          |       |         |        |       |          |          |     |         |       |        |               |           |                       |          |
| Firestone<br>W01-358-8050<br>W01-358-8058   |                                |   |                             |                      |                         |   |   |      |              |               |                  |             |             |       |          |       |         |        |       |          |          |     |         |       |        |               |           |                       |          |
| ContiTech   |                                |   |                             |                      |                         |   |   |      |              |               |                  |             |             |       |          |       |         |        |       |          |          |     |         |       |        |               |           |                       |          |
| GOODYEAR  |                                |   |                             |                      |                         |   |   |      |              |               |                  |             |             |       |          |       |         |        |       |          |          |     |         |       |        |               |           |                       |          |
| Code  | Manufacturer                   |   |                             |                      |                         |   |   |      |              |               |                  |             |             |       |          |       |         |        |       |          |          |     |         |       |        |               |           |                       |          |
| 3528050   | DAYTON                         |   |                             |                      |                         |   |   |      |              |               |                  |             |             |       |          |       |         |        |       |          |          |     |         |       |        |               |           |                       |          |
| B-12514-013   | HENDRICKSON                    |   |                             |                      |                         |   |   |      |              |               |                  |             |             |       |          |       |         |        |       |          |          |     |         |       |        |               |           |                       |          |
| S4771   |                                |   |                             |                      |                         |   |   |      |              |               |                  |             |             |       |          |       |         |        |       |          |          |     |         |       |        |               |           |                       |          |
| 36514-13  |                                |   |                             |                      |                         |   |   |      |              |               |                  |             |             |       |          |       |         |        |       |          |          |     |         |       |        |               |           |                       |          |
| S6002   | MERITOR                        |   |                             |                      |                         |   |   |      |              |               |                  |             |             |       |          |       |         |        |       |          |          |     |         |       |        |               |           |                       |          |
| 201680  | REYCO                          |   |                             |                      |                         |   |   |      |              |               |                  |             |             |       |          |       |         |        |       |          |          |     |         |       |        |               |           |                       |          |
| 23631-01  |                                |   |                             |                      |                         |   |   |      |              |               |                  |             |             |       |          |       |         |        |       |          |          |     |         |       |        |               |           |                       |          |
| 57008050  | SAF                            |   |                             |                      |                         |   |   |      |              |               |                  |             |             |       |          |       |         |        |       |          |          |     |         |       |        |               |           |                       |          |
| 3130498   | VOLVO                          |   |                             |                      |                         |   |   |      |              |               |                  |             |             |       |          |       |         |        |       |          |          |     |         |       |        |               |           |                       |          |
| AS0039  | WATSON-CHALIN                  |   |                             |                      |                         |   |   |      |              |               |                  |             |             |       |          |       |         |        |       |          |          |     |         |       |        |               |           |                       |          |
| 1685174C1   | NAVISTAR<br>FLEETRITE          |   |                             |                      |                         |   |   |      |              |               |                  |             |             |       |          |       |         |        |       |          |          |     |         |       |        |               |           |                       |          |
| 1R14-241  |                                |   |                             |                      |                         |   |   |      |              |               |                  |             |             |       |          |       |         |        |       |          |          |     |         |       |        |               |           |                       |          |
| <b>FM18014.C03A (Customized Product)</b>  |                                |   |                             |                      |                         |   |   |      |              |               |                  |             |             |       |          |       |         |        |       |          |          |     |         |       |        |               |           |                       |          |
| <table border="1"> <tr> <td data-bbox="153 931 381 1011">Competitor code</td> </tr> <tr> <td data-bbox="153 1011 381 1090">Firestone</td> </tr> <tr> <td data-bbox="153 1090 381 1170">ContiTech</td> </tr> <tr> <td data-bbox="153 1170 381 1250">GOODYEAR</td> </tr> <tr> <td data-bbox="153 1250 381 1310">VIBRACOUSTIC</td> </tr> </table>  | Competitor code                | Firestone                                 | ContiTech                   | GOODYEAR             | VIBRACOUSTIC            | <p>Piston: No</p>   | <table border="1"> <thead> <tr> <th data-bbox="951 931 1182 1011">Code</th> <th data-bbox="1187 931 1436 1011">Manufacturer</th> </tr> </thead> <tbody> <tr> <td data-bbox="951 1011 1182 1043"></td> <td data-bbox="1187 1011 1436 1043"></td> </tr> </tbody> </table> |      | Code         | Manufacturer  |                  |             |             |       |          |       |         |        |       |          |          |     |         |       |        |               |           |                       |          |
| Competitor code   |                                |   |                             |                      |                         |   |   |      |              |               |                  |             |             |       |          |       |         |        |       |          |          |     |         |       |        |               |           |                       |          |
| Firestone   |                                |   |                             |                      |                         |   |   |      |              |               |                  |             |             |       |          |       |         |        |       |          |          |     |         |       |        |               |           |                       |          |
| ContiTech   |                                |   |                             |                      |                         |   |   |      |              |               |                  |             |             |       |          |       |         |        |       |          |          |     |         |       |        |               |           |                       |          |
| GOODYEAR  |                                |   |                             |                      |                         |   |   |      |              |               |                  |             |             |       |          |       |         |        |       |          |          |     |         |       |        |               |           |                       |          |
| VIBRACOUSTIC  |                                |   |                             |                      |                         |   |   |      |              |               |                  |             |             |       |          |       |         |        |       |          |          |     |         |       |        |               |           |                       |          |
| Code  | Manufacturer                   |   |                             |                      |                         |   |   |      |              |               |                  |             |             |       |          |       |         |        |       |          |          |     |         |       |        |               |           |                       |          |
|   |                                |   |                             |                      |                         |   |   |      |              |               |                  |             |             |       |          |       |         |        |       |          |          |     |         |       |        |               |           |                       |          |
| <b>FM18014.C04A</b>   |                                |   |                             |                      |                         |   |   |      |              |               |                  |             |             |       |          |       |         |        |       |          |          |     |         |       |        |               |           |                       |          |
| <table border="1"> <tr> <td data-bbox="153 1491 381 1571">Competitor code</td> </tr> <tr> <td data-bbox="153 1571 381 1673">Firestone<br/>1T19ZK5.7<br/>W01-358-8050</td> </tr> <tr> <td data-bbox="153 1673 381 1752">ContiTech<br/>1110.5C-16A320</td> </tr> <tr> <td data-bbox="153 1752 381 1802">GOODYEAR<br/>1R14-039</td> </tr> </table> | Competitor code                | Firestone<br>1T19ZK5.7<br>W01-358-8050    | ContiTech<br>1110.5C-16A320 | GOODYEAR<br>1R14-039 | <p>Piston: Aluminum</p> | <table border="1"> <thead> <tr> <th data-bbox="951 1491 1182 1535">Code</th> <th data-bbox="1187 1491 1436 1535">Manufacturer</th> </tr> </thead> <tbody> <tr> <td data-bbox="951 1535 1182 1593">DZ95259440308</td> <td data-bbox="1187 1535 1436 1593">SHACMAN<br/>M3000</td> </tr> </tbody> </table>   |   | Code | Manufacturer | DZ95259440308 | SHACMAN<br>M3000 |             |             |       |          |       |         |        |       |          |          |     |         |       |        |               |           |                       |          |
| Competitor code   |                                |   |                             |                      |                         |   |   |      |              |               |                  |             |             |       |          |       |         |        |       |          |          |     |         |       |        |               |           |                       |          |
| Firestone<br>1T19ZK5.7<br>W01-358-8050  |                                |   |                             |                      |                         |   |   |      |              |               |                  |             |             |       |          |       |         |        |       |          |          |     |         |       |        |               |           |                       |          |
| ContiTech<br>1110.5C-16A320   |                                |   |                             |                      |                         |   |   |      |              |               |                  |             |             |       |          |       |         |        |       |          |          |     |         |       |        |               |           |                       |          |
| GOODYEAR<br>1R14-039  |                                |   |                             |                      |                         |   |   |      |              |               |                  |             |             |       |          |       |         |        |       |          |          |     |         |       |        |               |           |                       |          |
| Code  | Manufacturer                   |   |                             |                      |                         |   |   |      |              |               |                  |             |             |       |          |       |         |        |       |          |          |     |         |       |        |               |           |                       |          |
| DZ95259440308   | SHACMAN<br>M3000               |   |                             |                      |                         |   |   |      |              |               |                  |             |             |       |          |       |         |        |       |          |          |     |         |       |        |               |           |                       |          |



# Towing vehicle & Trailer & Semitrailer Air Springs

| Code  | Section, Top View, Bottom View | Applications                           |                             |                      |                                  |   |  |              |              |              |              |              |              |              |               |              |               |              |              |              |              |              |              |         |           |            |       |
|---|--------------------------------|--|-----------------------------|----------------------|----------------------------------|---|--|--------------|--------------|--------------|--------------|--------------|--------------|--------------|---------------|--------------|---------------|--------------|--------------|--------------|--------------|--------------|--------------|---------|-----------|------------|-------|
| <b>FM18014.C05A</b>   |                                |  |                             |                      |                                  |   |  |              |              |              |              |              |              |              |               |              |               |              |              |              |              |              |              |         |           |            |       |
| <table border="1"> <tr> <td>Competitor code</td> </tr> <tr> <td>Firestone<br/>W01-M58-8060</td> </tr> <tr> <td>ContiTech</td> </tr> <tr> <td>GOODYEAR</td> </tr> </table>   | Competitor code                | Firestone<br>W01-M58-8060              | ContiTech                   | GOODYEAR             | <p>Piston: Aluminum</p>          | <table border="1"> <tr> <th>Code</th> <th>Manufacturer</th> </tr> <tr> <td> </td> <td> </td> </tr> </table> | Code   | Manufacturer |              |              |              |              |              |              |               |              |               |              |              |              |              |              |              |         |           |            |       |
| Competitor code   |                                |  |                             |                      |                                  |   |  |              |              |              |              |              |              |              |               |              |               |              |              |              |              |              |              |         |           |            |       |
| Firestone<br>W01-M58-8060   |                                |  |                             |                      |                                  |   |  |              |              |              |              |              |              |              |               |              |               |              |              |              |              |              |              |         |           |            |       |
| ContiTech   |                                |  |                             |                      |                                  |   |  |              |              |              |              |              |              |              |               |              |               |              |              |              |              |              |              |         |           |            |       |
| GOODYEAR  |                                |  |                             |                      |                                  |   |  |              |              |              |              |              |              |              |               |              |               |              |              |              |              |              |              |         |           |            |       |
| Code  | Manufacturer                   |  |                             |                      |                                  |   |  |              |              |              |              |              |              |              |               |              |               |              |              |              |              |              |              |         |           |            |       |
|   |                                |  |                             |                      |                                  |   |  |              |              |              |              |              |              |              |               |              |               |              |              |              |              |              |              |         |           |            |       |
| <b>FM18015.C01A</b>   |                                |  |                             |                      |                                  |   |  |              |              |              |              |              |              |              |               |              |               |              |              |              |              |              |              |         |           |            |       |
| <table border="1"> <tr> <td>Competitor code</td> </tr> <tr> <td>Firestone<br/>1T15 ZR-6<br/>W01-358-9781</td> </tr> <tr> <td>ContiTech<br/>9 10S-16 A 382</td> </tr> <tr> <td>GOODYEAR<br/>1R12-603</td> </tr> <tr> <td>VIBRACOUSTIC</td> </tr> </table>                      | Competitor code                | Firestone<br>1T15 ZR-6<br>W01-358-9781 | ContiTech<br>9 10S-16 A 382 | GOODYEAR<br>1R12-603 | VIBRACOUSTIC                     | <p>Piston: Aluminum</p>   | <table border="1"> <tr> <th>Code</th> <th>Manufacturer</th> </tr> <tr> <td>16-15595-000</td> <td rowspan="10">FREIGHTLINER</td> </tr> <tr> <td>16-14004-000</td> </tr> <tr> <td>16-13840-000</td> </tr> <tr> <td>16-16773-000</td> </tr> <tr> <td>A16-14004-000</td> </tr> <tr> <td>681-320-0017</td> </tr> <tr> <td>16-13810-000</td> </tr> <tr> <td>16-19465-000</td> </tr> <tr> <td>16-19466-000</td> </tr> <tr> <td>16-14004-001</td> </tr> <tr> <td>SC 2750</td> <td>LOADGUARD</td> </tr> <tr> <td>85 101 151</td> <td>VOLVO</td> </tr> </table>  | Code         | Manufacturer | 16-15595-000 | FREIGHTLINER | 16-14004-000 | 16-13840-000 | 16-16773-000 | A16-14004-000 | 681-320-0017 | 16-13810-000  | 16-19465-000 | 16-19466-000 | 16-14004-001 | SC 2750      | LOADGUARD    | 85 101 151   | VOLVO   |           |            |       |
| Competitor code   |                                |  |                             |                      |                                  |   |  |              |              |              |              |              |              |              |               |              |               |              |              |              |              |              |              |         |           |            |       |
| Firestone<br>1T15 ZR-6<br>W01-358-9781  |                                |  |                             |                      |                                  |   |  |              |              |              |              |              |              |              |               |              |               |              |              |              |              |              |              |         |           |            |       |
| ContiTech<br>9 10S-16 A 382   |                                |  |                             |                      |                                  |   |  |              |              |              |              |              |              |              |               |              |               |              |              |              |              |              |              |         |           |            |       |
| GOODYEAR<br>1R12-603  |                                |  |                             |                      |                                  |   |  |              |              |              |              |              |              |              |               |              |               |              |              |              |              |              |              |         |           |            |       |
| VIBRACOUSTIC  |                                |  |                             |                      |                                  |   |  |              |              |              |              |              |              |              |               |              |               |              |              |              |              |              |              |         |           |            |       |
| Code  | Manufacturer                   |  |                             |                      |                                  |   |  |              |              |              |              |              |              |              |               |              |               |              |              |              |              |              |              |         |           |            |       |
| 16-15595-000  | FREIGHTLINER                   |  |                             |                      |                                  |   |  |              |              |              |              |              |              |              |               |              |               |              |              |              |              |              |              |         |           |            |       |
| 16-14004-000  |                                |  |                             |                      |                                  |   |  |              |              |              |              |              |              |              |               |              |               |              |              |              |              |              |              |         |           |            |       |
| 16-13840-000  |                                |  |                             |                      |                                  |   |  |              |              |              |              |              |              |              |               |              |               |              |              |              |              |              |              |         |           |            |       |
| 16-16773-000  |                                |  |                             |                      |                                  |   |  |              |              |              |              |              |              |              |               |              |               |              |              |              |              |              |              |         |           |            |       |
| A16-14004-000   |                                |  |                             |                      |                                  |   |  |              |              |              |              |              |              |              |               |              |               |              |              |              |              |              |              |         |           |            |       |
| 681-320-0017  |                                |  |                             |                      |                                  |   |  |              |              |              |              |              |              |              |               |              |               |              |              |              |              |              |              |         |           |            |       |
| 16-13810-000  |                                |  |                             |                      |                                  |   |  |              |              |              |              |              |              |              |               |              |               |              |              |              |              |              |              |         |           |            |       |
| 16-19465-000  |                                |  |                             |                      |                                  |   |  |              |              |              |              |              |              |              |               |              |               |              |              |              |              |              |              |         |           |            |       |
| 16-19466-000  |                                |  |                             |                      |                                  |   |  |              |              |              |              |              |              |              |               |              |               |              |              |              |              |              |              |         |           |            |       |
| 16-14004-001  |                                |  |                             |                      |                                  |   |  |              |              |              |              |              |              |              |               |              |               |              |              |              |              |              |              |         |           |            |       |
| SC 2750   | LOADGUARD                      |  |                             |                      |                                  |   |  |              |              |              |              |              |              |              |               |              |               |              |              |              |              |              |              |         |           |            |       |
| 85 101 151  | VOLVO                          |  |                             |                      |                                  |   |  |              |              |              |              |              |              |              |               |              |               |              |              |              |              |              |              |         |           |            |       |
| <b>FM18015.C02P</b>   |                                |  |                             |                      |                                  |   |  |              |              |              |              |              |              |              |               |              |               |              |              |              |              |              |              |         |           |            |       |
| <table border="1"> <tr> <td>Competitor code</td> </tr> <tr> <td>Firestone<br/>1T15 ZR-6<br/>W01-358-9780</td> </tr> <tr> <td>ContiTech<br/>9 10S-16 A 999</td> </tr> <tr> <td>GOODYEAR<br/>1R12-303</td> </tr> <tr> <td>VIBRACOUSTIC<br/>V 1 DK 23 K-9780</td> </tr> </table> | Competitor code                | Firestone<br>1T15 ZR-6<br>W01-358-9780 | ContiTech<br>9 10S-16 A 999 | GOODYEAR<br>1R12-303 | VIBRACOUSTIC<br>V 1 DK 23 K-9780 | <p>Piston: Composite</p>  | <table border="1"> <tr> <th>Code</th> <th>Manufacturer</th> </tr> <tr> <td>16-14004-000</td> <td rowspan="14">FREIGHTLINER</td> </tr> <tr> <td>16-13840-000</td> </tr> <tr> <td>16-16773-000</td> </tr> <tr> <td>16-14004-001</td> </tr> <tr> <td>16-13810-002</td> </tr> <tr> <td>16-14377-000</td> </tr> <tr> <td>A16-13668-002</td> </tr> <tr> <td>16-19468-000</td> </tr> <tr> <td>16-19467-000</td> </tr> <tr> <td>16-13810-001</td> </tr> <tr> <td>16-15595-001</td> </tr> <tr> <td>16-15595-002</td> </tr> <tr> <td>16-16825-000</td> </tr> <tr> <td>SC 2750</td> <td>LOADGUARD</td> </tr> <tr> <td>85 101 151</td> <td>VOLVO</td> </tr> </table> | Code         | Manufacturer | 16-14004-000 | FREIGHTLINER | 16-13840-000 | 16-16773-000 | 16-14004-001 | 16-13810-002  | 16-14377-000 | A16-13668-002 | 16-19468-000 | 16-19467-000 | 16-13810-001 | 16-15595-001 | 16-15595-002 | 16-16825-000 | SC 2750 | LOADGUARD | 85 101 151 | VOLVO |
| Competitor code   |                                |  |                             |                      |                                  |   |  |              |              |              |              |              |              |              |               |              |               |              |              |              |              |              |              |         |           |            |       |
| Firestone<br>1T15 ZR-6<br>W01-358-9780  |                                |  |                             |                      |                                  |   |  |              |              |              |              |              |              |              |               |              |               |              |              |              |              |              |              |         |           |            |       |
| ContiTech<br>9 10S-16 A 999   |                                |  |                             |                      |                                  |   |  |              |              |              |              |              |              |              |               |              |               |              |              |              |              |              |              |         |           |            |       |
| GOODYEAR<br>1R12-303  |                                |  |                             |                      |                                  |   |  |              |              |              |              |              |              |              |               |              |               |              |              |              |              |              |              |         |           |            |       |
| VIBRACOUSTIC<br>V 1 DK 23 K-9780  |                                |  |                             |                      |                                  |   |  |              |              |              |              |              |              |              |               |              |               |              |              |              |              |              |              |         |           |            |       |
| Code  | Manufacturer                   |  |                             |                      |                                  |   |  |              |              |              |              |              |              |              |               |              |               |              |              |              |              |              |              |         |           |            |       |
| 16-14004-000  | FREIGHTLINER                   |  |                             |                      |                                  |   |  |              |              |              |              |              |              |              |               |              |               |              |              |              |              |              |              |         |           |            |       |
| 16-13840-000  |                                |  |                             |                      |                                  |   |  |              |              |              |              |              |              |              |               |              |               |              |              |              |              |              |              |         |           |            |       |
| 16-16773-000  |                                |  |                             |                      |                                  |   |  |              |              |              |              |              |              |              |               |              |               |              |              |              |              |              |              |         |           |            |       |
| 16-14004-001  |                                |  |                             |                      |                                  |   |  |              |              |              |              |              |              |              |               |              |               |              |              |              |              |              |              |         |           |            |       |
| 16-13810-002  |                                |  |                             |                      |                                  |   |  |              |              |              |              |              |              |              |               |              |               |              |              |              |              |              |              |         |           |            |       |
| 16-14377-000  |                                |  |                             |                      |                                  |   |  |              |              |              |              |              |              |              |               |              |               |              |              |              |              |              |              |         |           |            |       |
| A16-13668-002   |                                |  |                             |                      |                                  |   |  |              |              |              |              |              |              |              |               |              |               |              |              |              |              |              |              |         |           |            |       |
| 16-19468-000  |                                |  |                             |                      |                                  |   |  |              |              |              |              |              |              |              |               |              |               |              |              |              |              |              |              |         |           |            |       |
| 16-19467-000  |                                |  |                             |                      |                                  |   |  |              |              |              |              |              |              |              |               |              |               |              |              |              |              |              |              |         |           |            |       |
| 16-13810-001  |                                |  |                             |                      |                                  |   |  |              |              |              |              |              |              |              |               |              |               |              |              |              |              |              |              |         |           |            |       |
| 16-15595-001  |                                |  |                             |                      |                                  |   |  |              |              |              |              |              |              |              |               |              |               |              |              |              |              |              |              |         |           |            |       |
| 16-15595-002  |                                |  |                             |                      |                                  |   |  |              |              |              |              |              |              |              |               |              |               |              |              |              |              |              |              |         |           |            |       |
| 16-16825-000  |                                |  |                             |                      |                                  |   |  |              |              |              |              |              |              |              |               |              |               |              |              |              |              |              |              |         |           |            |       |
| SC 2750   |                                | LOADGUARD                              |                             |                      |                                  |   |  |              |              |              |              |              |              |              |               |              |               |              |              |              |              |              |              |         |           |            |       |
| 85 101 151  | VOLVO                          |  |                             |                      |                                  |   |  |              |              |              |              |              |              |              |               |              |               |              |              |              |              |              |              |         |           |            |       |



# Towing vehicle & Trailer & Semitrailer Air Springs

| Code   | Section, Top View, Bottom View | Applications |          |              |  |          |       |                         |          |       |                      |          |       |                               |         |       |  |  |
|--|--------------------------------|--------------|----------|--------------|--|----------|-------|-------------------------|----------|-------|----------------------|----------|-------|-------------------------------|---------|-------|--|--|
| <b>FM18019.H01</b>   |                                |              |          |              |  |          |       |                         |          |       |                      |          |       |                               |         |       |  |  |
| <table border="1"> <tr> <td>Competitor code</td> <td rowspan="5"> </td> <td>Code</td> <td>Manufacturer</td> </tr> <tr> <td>Firestone</td> <td></td> <td></td> </tr> <tr> <td>ContiTech</td> <td></td> <td></td> </tr> <tr> <td>GOODYEAR</td> <td></td> <td></td> </tr> <tr> <td>VIBRACOUSTIC</td> <td></td> <td></td> </tr> </table>   | Competitor code                |              | Code     | Manufacturer | Firestone                                  |          |       | ContiTech               |          |       | GOODYEAR             |          |       | VIBRACOUSTIC                  |         |       |  |  |
| Competitor code  |                                |              | Code     | Manufacturer |  |          |       |                         |          |       |                      |          |       |                               |         |       |  |  |
| Firestone  |                                |              |          |              |  |          |       |                         |          |       |                      |          |       |                               |         |       |  |  |
| ContiTech  |                                |              |          |              |  |          |       |                         |          |       |                      |          |       |                               |         |       |  |  |
| GOODYEAR   |                                |              |          |              |  |          |       |                         |          |       |                      |          |       |                               |         |       |  |  |
| VIBRACOUSTIC   |                                |              |          |              |  |          |       |                         |          |       |                      |          |       |                               |         |       |  |  |
| 6605 N P01<br>Service assembly for<br>6605 N P01   | Piston: No                     |              |          |              |  |          |       |                         |          |       |                      |          |       |                               |         |       |  |  |
| <b>FM18019.H02</b>   |                                |              |          |              |  |          |       |                         |          |       |                      |          |       |                               |         |       |  |  |
| <table border="1"> <tr> <td>Competitor code</td> <td rowspan="5"> </td> <td>Code</td> <td>Manufacturer</td> </tr> <tr> <td>Firestone</td> <td></td> <td></td> </tr> <tr> <td>ContiTech</td> <td></td> <td></td> </tr> <tr> <td>GOODYEAR</td> <td></td> <td></td> </tr> <tr> <td>VIBRACOUSTIC</td> <td></td> <td></td> </tr> </table>   | Competitor code                |              | Code     | Manufacturer | Firestone                                  |          |       | ContiTech               |          |       | GOODYEAR             |          |       | VIBRACOUSTIC                  |         |       |  |  |
| Competitor code  |                                |              | Code     | Manufacturer |  |          |       |                         |          |       |                      |          |       |                               |         |       |  |  |
| Firestone  |                                |              |          |              |  |          |       |                         |          |       |                      |          |       |                               |         |       |  |  |
| ContiTech  |                                |              |          |              |  |          |       |                         |          |       |                      |          |       |                               |         |       |  |  |
| GOODYEAR   |                                |              |          |              |  |          |       |                         |          |       |                      |          |       |                               |         |       |  |  |
| VIBRACOUSTIC   |                                |              |          |              |  |          |       |                         |          |       |                      |          |       |                               |         |       |  |  |
| 4560 N P02<br>Service assembly for<br>4560 N P02   | Piston: No                     |              |          |              |  |          |       |                         |          |       |                      |          |       |                               |         |       |  |  |
| <b>FM18019.C01</b>   |                                |              |          |              |  |          |       |                         |          |       |                      |          |       |                               |         |       |  |  |
| <table border="1"> <tr> <td>Competitor code</td> <td rowspan="5"> </td> <td>Code</td> <td>Manufacturer</td> </tr> <tr> <td>Firestone<br/>1T15LR SERIES<br/>W01-M58-8472</td> <td>20456150</td> <td>VOLVO</td> </tr> <tr> <td>ContiTech<br/>6605 N P01</td> <td>20582206</td> <td>VOLVO</td> </tr> <tr> <td>GOODYEAR<br/>1R11-805</td> <td>20531984</td> <td>VOLVO</td> </tr> <tr> <td>VIBRACOUSTIC<br/>V 1 DF 20 B-1</td> <td>1075890</td> <td>VOLVO</td> </tr> </table> | Competitor code                |              | Code     | Manufacturer | Firestone<br>1T15LR SERIES<br>W01-M58-8472 | 20456150 | VOLVO | ContiTech<br>6605 N P01 | 20582206 | VOLVO | GOODYEAR<br>1R11-805 | 20531984 | VOLVO | VIBRACOUSTIC<br>V 1 DF 20 B-1 | 1075890 | VOLVO |  |  |
| Competitor code  |                                |              | Code     | Manufacturer |  |          |       |                         |          |       |                      |          |       |                               |         |       |  |  |
| Firestone<br>1T15LR SERIES<br>W01-M58-8472   |                                |              | 20456150 | VOLVO        |  |          |       |                         |          |       |                      |          |       |                               |         |       |  |  |
| ContiTech<br>6605 N P01  |                                |              | 20582206 | VOLVO        |  |          |       |                         |          |       |                      |          |       |                               |         |       |  |  |
| GOODYEAR<br>1R11-805   |                                |              | 20531984 | VOLVO        |  |          |       |                         |          |       |                      |          |       |                               |         |       |  |  |
| VIBRACOUSTIC<br>V 1 DF 20 B-1  |                                | 1075890      | VOLVO    |              |  |          |       |                         |          |       |                      |          |       |                               |         |       |  |  |
|  | Piston: Steel                  | 3171692      | VOLVO    |              |  |          |       |                         |          |       |                      |          |       |                               |         |       |  |  |
|  |                                | 20375226     | VOLVO    |              |  |          |       |                         |          |       |                      |          |       |                               |         |       |  |  |
|  |                                | 20375227     | VOLVO    |              |  |          |       |                         |          |       |                      |          |       |                               |         |       |  |  |
|  |                                | 20427800     | VOLVO    |              |  |          |       |                         |          |       |                      |          |       |                               |         |       |  |  |
|  |                                | 20582206     | VOLVO    |              |  |          |       |                         |          |       |                      |          |       |                               |         |       |  |  |



# Towing vehicle & Trailer & Semitrailer Air Springs

| Code  | Section, Top View, Bottom View | Applications                               |                         |  |  |                          |  |              |          |              |            |        |         |        |         |        |         |        |
|---|--------------------------------|--|-------------------------|--|--|--------------------------|--|--------------|----------|--------------|------------|--------|---------|--------|---------|--------|---------|--------|
| <b>FM18019.C02</b>  |                                |  |                         |  |  |                          |  |              |          |              |            |        |         |        |         |        |         |        |
| <table border="1"> <tr> <td>Competitor code</td> </tr> <tr> <td>Firestone<br/>1T15JR SERIES<br/>W01-M58-6088</td> </tr> <tr> <td>ContiTech<br/>4560 N P02</td> </tr> </table>   | Competitor code                | Firestone<br>1T15JR SERIES<br>W01-M58-6088 | ContiTech<br>4560 N P02 | <p>Piston: Steel</p>                           | <table border="1"> <thead> <tr> <th>Code</th> <th>Manufacturer</th> </tr> </thead> <tbody> <tr> <td>22058737</td> <td>VOLVO</td> </tr> <tr> <td>21 224 745</td> <td>VOLVO</td> </tr> </tbody> </table> |                          | Code   | Manufacturer | 22058737 | VOLVO        | 21 224 745 | VOLVO  |         |        |         |        |         |        |
| Competitor code   |                                |  |                         |  |  |                          |  |              |          |              |            |        |         |        |         |        |         |        |
| Firestone<br>1T15JR SERIES<br>W01-M58-6088  |                                |  |                         |  |  |                          |  |              |          |              |            |        |         |        |         |        |         |        |
| ContiTech<br>4560 N P02   |                                |  |                         |  |  |                          |  |              |          |              |            |        |         |        |         |        |         |        |
| Code  | Manufacturer                   |  |                         |  |  |                          |  |              |          |              |            |        |         |        |         |        |         |        |
| 22058737  | VOLVO                          |  |                         |  |  |                          |  |              |          |              |            |        |         |        |         |        |         |        |
| 21 224 745  | VOLVO                          |  |                         |  |  |                          |  |              |          |              |            |        |         |        |         |        |         |        |
| <b>FM18020.H01</b>  |                                |  |                         |  |  |                          |  |              |          |              |            |        |         |        |         |        |         |        |
| <table border="1"> <tr> <td>Competitor code</td> </tr> <tr> <td>Firestone</td> </tr> <tr> <td>ContiTech</td> </tr> <tr> <td>GOODYEAR</td> </tr> <tr> <td>VIBRACOUSTIC</td> </tr> </table>   | Competitor code                | Firestone                                  | ContiTech               | GOODYEAR                                       | VIBRACOUSTIC   | <p>Piston: No</p>        | <table border="1"> <thead> <tr> <th>Code</th> <th>Manufacturer</th> </tr> </thead> <tbody> <tr> <td> </td> <td> </td> </tr> </tbody> </table>  |              | Code     | Manufacturer |            |        |         |        |         |        |         |        |
| Competitor code   |                                |  |                         |  |  |                          |  |              |          |              |            |        |         |        |         |        |         |        |
| Firestone   |                                |  |                         |  |  |                          |  |              |          |              |            |        |         |        |         |        |         |        |
| ContiTech   |                                |  |                         |  |  |                          |  |              |          |              |            |        |         |        |         |        |         |        |
| GOODYEAR  |                                |  |                         |  |  |                          |  |              |          |              |            |        |         |        |         |        |         |        |
| VIBRACOUSTIC  |                                |  |                         |  |  |                          |  |              |          |              |            |        |         |        |         |        |         |        |
| Code  | Manufacturer                   |  |                         |  |  |                          |  |              |          |              |            |        |         |        |         |        |         |        |
|   |                                |  |                         |  |  |                          |  |              |          |              |            |        |         |        |         |        |         |        |
| <b>FM18020.C01P</b>   |                                |  |                         |  |  |                          |  |              |          |              |            |        |         |        |         |        |         |        |
| <table border="1"> <tr> <td>Competitor code</td> </tr> <tr> <td>Firestone<br/>1T15LP-3<br/>W01-M58-6251</td> </tr> <tr> <td>ContiTech<br/>6705 N P01</td> </tr> <tr> <td>GOODYEAR<br/>1R11-<br/>822/1R11-826/<br/>1R11-802</td> </tr> <tr> <td>VIBRACOUSTIC<br/>V 1 DK 18 A-1</td> </tr> </table> | Competitor code                | Firestone<br>1T15LP-3<br>W01-M58-6251      | ContiTech<br>6705 N P01 | GOODYEAR<br>1R11-<br>822/1R11-826/<br>1R11-802 | VIBRACOUSTIC<br>V 1 DK 18 A-1  | <p>Piston: Composite</p> | <table border="1"> <thead> <tr> <th>Code</th> <th>Manufacturer</th> </tr> </thead> <tbody> <tr> <td>1865759</td> <td>SCANIA</td> </tr> <tr> <td>1402423</td> <td>SCANIA</td> </tr> <tr> <td>1394997</td> <td>SCANIA</td> </tr> <tr> <td>1314903</td> <td>SCANIA</td> </tr> </tbody> </table> |              | Code     | Manufacturer | 1865759    | SCANIA | 1402423 | SCANIA | 1394997 | SCANIA | 1314903 | SCANIA |
| Competitor code   |                                |  |                         |  |  |                          |  |              |          |              |            |        |         |        |         |        |         |        |
| Firestone<br>1T15LP-3<br>W01-M58-6251   |                                |  |                         |  |  |                          |  |              |          |              |            |        |         |        |         |        |         |        |
| ContiTech<br>6705 N P01   |                                |  |                         |  |  |                          |  |              |          |              |            |        |         |        |         |        |         |        |
| GOODYEAR<br>1R11-<br>822/1R11-826/<br>1R11-802  |                                |  |                         |  |  |                          |  |              |          |              |            |        |         |        |         |        |         |        |
| VIBRACOUSTIC<br>V 1 DK 18 A-1   |                                |  |                         |  |  |                          |  |              |          |              |            |        |         |        |         |        |         |        |
| Code  | Manufacturer                   |  |                         |  |  |                          |  |              |          |              |            |        |         |        |         |        |         |        |
| 1865759   | SCANIA                         |  |                         |  |  |                          |  |              |          |              |            |        |         |        |         |        |         |        |
| 1402423   | SCANIA                         |  |                         |  |  |                          |  |              |          |              |            |        |         |        |         |        |         |        |
| 1394997   | SCANIA                         |  |                         |  |  |                          |  |              |          |              |            |        |         |        |         |        |         |        |
| 1314903   | SCANIA                         |  |                         |  |  |                          |  |              |          |              |            |        |         |        |         |        |         |        |



# Towing vehicle & Trailer & Semitrailer Air Springs

| Code   | Section, Top View, Bottom View | Applications              |                                |          |              |  |   |      |              |              |                             |                           |
|--|--------------------------------|---------------------------|--------------------------------|----------|--------------|--|---|------|--------------|--------------|-----------------------------|---------------------------|
| <b>FM18021.C01P</b>  |                                |                           |                                |          |              |  |   |      |              |              |                             |                           |
| <table border="1" style="width: 100%; border-collapse: collapse;"> <tr> <td style="padding: 5px;">Competitor code</td> </tr> <tr> <td style="padding: 5px;">Firestone<br/>W01-358-7402</td> </tr> <tr> <td style="padding: 5px;">ContiTech<br/>10 10B-16 P 162</td> </tr> <tr> <td style="padding: 5px;">GOODYEAR</td> </tr> </table>  | Competitor code                | Firestone<br>W01-358-7402 | ContiTech<br>10 10B-16 P 162   | GOODYEAR |              | <table border="1" style="width: 100%; border-collapse: collapse;"> <tr> <th style="width: 50%;">Code</th> <th style="width: 50%;">Manufacturer</th> </tr> <tr> <td style="text-align: center;">90557402</td> <td style="text-align: center;">SAF-HOLLAND</td> </tr> </table> |   | Code | Manufacturer | 90557402     | SAF-HOLLAND                 |                           |
| Competitor code  |                                |                           |                                |          |              |  |   |      |              |              |                             |                           |
| Firestone<br>W01-358-7402  |                                |                           |                                |          |              |  |   |      |              |              |                             |                           |
| ContiTech<br>10 10B-16 P 162   |                                |                           |                                |          |              |  |   |      |              |              |                             |                           |
| GOODYEAR   |                                |                           |                                |          |              |  |   |      |              |              |                             |                           |
| Code   | Manufacturer                   |                           |                                |          |              |  |   |      |              |              |                             |                           |
| 90557402   | SAF-HOLLAND                    |                           |                                |          |              |  |   |      |              |              |                             |                           |
| Piston: Composite  |                                |                           |                                |          |              |  |   |      |              |              |                             |                           |
| <b>FM18024.C01P</b>  |                                |                           |                                |          |              |  |   |      |              |              |                             |                           |
| <table border="1" style="width: 100%; border-collapse: collapse;"> <tr> <td style="padding: 5px;">Competitor code</td> </tr> <tr> <td style="padding: 5px;">Firestone<br/>W01-M58-8093</td> </tr> <tr> <td style="padding: 5px;">ContiTech<br/>11 10.5B-18 P 743</td> </tr> <tr> <td style="padding: 5px;">GOODYEAR</td> </tr> <tr> <td style="padding: 5px;">VIBRACOUSTIC</td> </tr> </table> | Competitor code                | Firestone<br>W01-M58-8093 | ContiTech<br>11 10.5B-18 P 743 | GOODYEAR | VIBRACOUSTIC |  | <table border="1" style="width: 100%; border-collapse: collapse;"> <tr> <th style="width: 50%;">Code</th> <th style="width: 50%;">Manufacturer</th> </tr> <tr> <td style="text-align: center;">S23748<br/>S24443<br/>C-23748</td> <td style="text-align: center;">HUAJIN<br/><br/>Hendrickson</td> </tr> </table> |      | Code         | Manufacturer | S23748<br>S24443<br>C-23748 | HUAJIN<br><br>Hendrickson |
| Competitor code  |                                |                           |                                |          |              |  |   |      |              |              |                             |                           |
| Firestone<br>W01-M58-8093  |                                |                           |                                |          |              |  |   |      |              |              |                             |                           |
| ContiTech<br>11 10.5B-18 P 743   |                                |                           |                                |          |              |  |   |      |              |              |                             |                           |
| GOODYEAR   |                                |                           |                                |          |              |  |   |      |              |              |                             |                           |
| VIBRACOUSTIC   |                                |                           |                                |          |              |  |   |      |              |              |                             |                           |
| Code   | Manufacturer                   |                           |                                |          |              |  |   |      |              |              |                             |                           |
| S23748<br>S24443<br>C-23748  | HUAJIN<br><br>Hendrickson      |                           |                                |          |              |  |   |      |              |              |                             |                           |
| Piston: Composite  |                                |                           |                                |          |              |  |   |      |              |              |                             |                           |
| <b>FM18025.H01</b>   |                                |                           |                                |          |              |  |   |      |              |              |                             |                           |
| <table border="1" style="width: 100%; border-collapse: collapse;"> <tr> <td style="padding: 5px;">Competitor code</td> </tr> <tr> <td style="padding: 5px;">Firestone</td> </tr> <tr> <td style="padding: 5px;">ContiTech</td> </tr> <tr> <td style="padding: 5px;">GOODYEAR</td> </tr> </table>   | Competitor code                | Firestone                 | ContiTech                      | GOODYEAR |              | <table border="1" style="width: 100%; border-collapse: collapse;"> <tr> <th style="width: 50%;">Code</th> <th style="width: 50%;">Manufacturer</th> </tr> <tr> <td style="height: 40px;"></td> <td style="height: 40px;"></td> </tr> </table>                                |   | Code | Manufacturer |              |                             |                           |
| Competitor code  |                                |                           |                                |          |              |  |   |      |              |              |                             |                           |
| Firestone  |                                |                           |                                |          |              |  |   |      |              |              |                             |                           |
| ContiTech  |                                |                           |                                |          |              |  |   |      |              |              |                             |                           |
| GOODYEAR   |                                |                           |                                |          |              |  |   |      |              |              |                             |                           |
| Code   | Manufacturer                   |                           |                                |          |              |  |   |      |              |              |                             |                           |
|  |                                |                           |                                |          |              |  |   |      |              |              |                             |                           |
| Piston: No   |                                |                           |                                |          |              |  |   |      |              |              |                             |                           |



# Towing vehicle & Trailer & Semitrailer Air Springs

| Code  | Section, Top View, Bottom View | Applications                               |                         |          |  |   |  |      |              |              |       |  |
|---|--------------------------------|--|-------------------------|----------|--|---|--|------|--------------|--------------|-------|--|
| <b>FM18025.H02</b>  |                                |  |                         |          |  |   |  |      |              |              |       |  |
| <table border="1"> <tr><td>Competitor code</td></tr> <tr><td>Firestone</td></tr> <tr><td>ContiTech</td></tr> <tr><td>GOODYEAR</td></tr> <tr><td>4570 N P02<br/>Service assembly for<br/>4570 N P02</td></tr> </table> | Competitor code                | Firestone                                  | ContiTech               | GOODYEAR | 4570 N P02<br>Service assembly for<br>4570 N P02 | <p>Piston: No</p>   | <table border="1"> <tr> <th data-bbox="952 418 1193 482">Code</th> <th data-bbox="1197 418 1441 482">Manufacturer</th> </tr> <tr> <td> </td> <td> </td> </tr> </table> |      | Code         | Manufacturer |       |  |
| Competitor code   |                                |  |                         |          |  |   |  |      |              |              |       |  |
| Firestone   |                                |  |                         |          |  |   |  |      |              |              |       |  |
| ContiTech   |                                |  |                         |          |  |   |  |      |              |              |       |  |
| GOODYEAR  |                                |  |                         |          |  |   |  |      |              |              |       |  |
| 4570 N P02<br>Service assembly for<br>4570 N P02  |                                |  |                         |          |  |   |  |      |              |              |       |  |
| Code  | Manufacturer                   |  |                         |          |  |   |  |      |              |              |       |  |
|   |                                |  |                         |          |  |   |  |      |              |              |       |  |
| <b>FM18025.H03</b>  |                                |  |                         |          |  |   |  |      |              |              |       |  |
| <table border="1"> <tr><td>Competitor code</td></tr> <tr><td>Firestone</td></tr> <tr><td>ContiTech</td></tr> <tr><td>GOODYEAR</td></tr> <tr><td>4570 N P01<br/>Service assembly for<br/>4570 N P01</td></tr> </table> | Competitor code                | Firestone                                  | ContiTech               | GOODYEAR | 4570 N P01<br>Service assembly for<br>4570 N P01 | <p>Piston: No</p>   | <table border="1"> <tr> <th data-bbox="952 896 1193 961">Code</th> <th data-bbox="1197 896 1441 961">Manufacturer</th> </tr> <tr> <td> </td> <td> </td> </tr> </table> |      | Code         | Manufacturer |       |  |
| Competitor code   |                                |  |                         |          |  |   |  |      |              |              |       |  |
| Firestone   |                                |  |                         |          |  |   |  |      |              |              |       |  |
| ContiTech   |                                |  |                         |          |  |   |  |      |              |              |       |  |
| GOODYEAR  |                                |  |                         |          |  |   |  |      |              |              |       |  |
| 4570 N P01<br>Service assembly for<br>4570 N P01  |                                |  |                         |          |  |   |  |      |              |              |       |  |
| Code  | Manufacturer                   |  |                         |          |  |   |  |      |              |              |       |  |
|   |                                |  |                         |          |  |   |  |      |              |              |       |  |
| <b>FM18025.C01</b>  |                                |  |                         |          |  |   |  |      |              |              |       |  |
| <table border="1"> <tr><td>Competitor code</td></tr> <tr><td>Firestone<br/>1T15UR SERIES<br/>W01-M58-8545</td></tr> <tr><td>ContiTech<br/>4570 N P02</td></tr> <tr><td>GOODYEAR</td></tr> </table>                    | Competitor code                | Firestone<br>1T15UR SERIES<br>W01-M58-8545 | ContiTech<br>4570 N P02 | GOODYEAR | <p>Piston: Composite</p>                         | <table border="1"> <tr> <th data-bbox="952 1427 1193 1491">Code</th> <th data-bbox="1197 1427 1441 1491">Manufacturer</th> </tr> <tr> <td>22058741</td> <td>VOLVO</td> </tr> </table> |  | Code | Manufacturer | 22058741     | VOLVO |  |
| Competitor code   |                                |  |                         |          |  |   |  |      |              |              |       |  |
| Firestone<br>1T15UR SERIES<br>W01-M58-8545  |                                |  |                         |          |  |   |  |      |              |              |       |  |
| ContiTech<br>4570 N P02   |                                |  |                         |          |  |   |  |      |              |              |       |  |
| GOODYEAR  |                                |  |                         |          |  |   |  |      |              |              |       |  |
| Code  | Manufacturer                   |  |                         |          |  |   |  |      |              |              |       |  |
| 22058741  | VOLVO                          |  |                         |          |  |   |  |      |              |              |       |  |



# Towing vehicle & Trailer & Semitrailer Air Springs

| Code   | Section, Top View, Bottom View | Applications                               |                          |                      |                               |  |   |              |              |               |       |          |       |          |       |          |       |          |       |
|--|--------------------------------|--|--------------------------|----------------------|-------------------------------|--|---|--------------|--------------|---------------|-------|----------|-------|----------|-------|----------|-------|----------|-------|
| <b>FM18025.C02</b>   |                                |  |                          |                      |                               |  |   |              |              |               |       |          |       |          |       |          |       |          |       |
| <table border="1"> <tr> <td>Competitor code</td> </tr> <tr> <td>Firestone<br/>1T15UR SERIES<br/>W01-M58-8474</td> </tr> <tr> <td>ContiTech<br/>6608 N P01</td> </tr> <tr> <td>GOODYEAR<br/>1R10-704</td> </tr> <tr> <td>VIBRACOUSTIC<br/>V 1 DF 16 D-1</td> </tr> </table> | Competitor code                | Firestone<br>1T15UR SERIES<br>W01-M58-8474 | ContiTech<br>6608 N P01  | GOODYEAR<br>1R10-704 | VIBRACOUSTIC<br>V 1 DF 16 D-1 | <p>Piston: Steel</p>   | <table border="1"> <thead> <tr> <th>Code</th> <th>Manufacturer</th> </tr> </thead> <tbody> <tr> <td>1076416</td> <td>VOLVO</td> </tr> <tr> <td>20456152</td> <td>VOLVO</td> </tr> <tr> <td>20374510</td> <td>VOLVO</td> </tr> <tr> <td>20531985</td> <td>VOLVO</td> </tr> <tr> <td>20582215</td> <td>VOLVO</td> </tr> </tbody> </table> | Code         | Manufacturer | 1076416       | VOLVO | 20456152 | VOLVO | 20374510 | VOLVO | 20531985 | VOLVO | 20582215 | VOLVO |
| Competitor code  |                                |  |                          |                      |                               |  |   |              |              |               |       |          |       |          |       |          |       |          |       |
| Firestone<br>1T15UR SERIES<br>W01-M58-8474   |                                |  |                          |                      |                               |  |   |              |              |               |       |          |       |          |       |          |       |          |       |
| ContiTech<br>6608 N P01  |                                |  |                          |                      |                               |  |   |              |              |               |       |          |       |          |       |          |       |          |       |
| GOODYEAR<br>1R10-704   |                                |  |                          |                      |                               |  |   |              |              |               |       |          |       |          |       |          |       |          |       |
| VIBRACOUSTIC<br>V 1 DF 16 D-1  |                                |  |                          |                      |                               |  |   |              |              |               |       |          |       |          |       |          |       |          |       |
| Code   | Manufacturer                   |  |                          |                      |                               |  |   |              |              |               |       |          |       |          |       |          |       |          |       |
| 1076416  | VOLVO                          |  |                          |                      |                               |  |   |              |              |               |       |          |       |          |       |          |       |          |       |
| 20456152   | VOLVO                          |  |                          |                      |                               |  |   |              |              |               |       |          |       |          |       |          |       |          |       |
| 20374510   | VOLVO                          |  |                          |                      |                               |  |   |              |              |               |       |          |       |          |       |          |       |          |       |
| 20531985   | VOLVO                          |  |                          |                      |                               |  |   |              |              |               |       |          |       |          |       |          |       |          |       |
| 20582215   | VOLVO                          |  |                          |                      |                               |  |   |              |              |               |       |          |       |          |       |          |       |          |       |
| <b>FM18025.C03</b>   |                                |  |                          |                      |                               |  |   |              |              |               |       |          |       |          |       |          |       |          |       |
| <table border="1"> <tr> <td>Competitor code</td> </tr> <tr> <td>Firestone</td> </tr> <tr> <td>ContiTech<br/>4570 N P01</td> </tr> <tr> <td>GOODYEAR</td> </tr> </table>  | Competitor code                | Firestone                                  | ContiTech<br>4570 N P01  | GOODYEAR             | <p>Piston: Composite</p>      | <table border="1"> <thead> <tr> <th>Code</th> <th>Manufacturer</th> </tr> </thead> <tbody> <tr> <td>21224749</td> <td>VOLVO</td> </tr> </tbody> </table> | Code  | Manufacturer | 21224749     | VOLVO         |       |          |       |          |       |          |       |          |       |
| Competitor code  |                                |  |                          |                      |                               |  |   |              |              |               |       |          |       |          |       |          |       |          |       |
| Firestone  |                                |  |                          |                      |                               |  |   |              |              |               |       |          |       |          |       |          |       |          |       |
| ContiTech<br>4570 N P01  |                                |  |                          |                      |                               |  |   |              |              |               |       |          |       |          |       |          |       |          |       |
| GOODYEAR   |                                |  |                          |                      |                               |  |   |              |              |               |       |          |       |          |       |          |       |          |       |
| Code   | Manufacturer                   |  |                          |                      |                               |  |   |              |              |               |       |          |       |          |       |          |       |          |       |
| 21224749   | VOLVO                          |  |                          |                      |                               |  |   |              |              |               |       |          |       |          |       |          |       |          |       |
| <b>FM18028.H01</b>   |                                |  |                          |                      |                               |  |   |              |              |               |       |          |       |          |       |          |       |          |       |
| <table border="1"> <tr> <td>Competitor code</td> </tr> <tr> <td>Firestone</td> </tr> <tr> <td>ContiTech<br/>4916 N1 P01</td> </tr> <tr> <td>GOODYEAR</td> </tr> <tr> <td>VIBRACOUSTIC</td> </tr> </table>  | Competitor code                | Firestone                                  | ContiTech<br>4916 N1 P01 | GOODYEAR             | VIBRACOUSTIC                  | <p>Piston: No</p>  | <table border="1"> <thead> <tr> <th>Code</th> <th>Manufacturer</th> </tr> </thead> <tbody> <tr> <td>81.43600.6042</td> <td>MAN</td> </tr> </tbody> </table>   | Code         | Manufacturer | 81.43600.6042 | MAN   |          |       |          |       |          |       |          |       |
| Competitor code  |                                |  |                          |                      |                               |  |   |              |              |               |       |          |       |          |       |          |       |          |       |
| Firestone  |                                |  |                          |                      |                               |  |   |              |              |               |       |          |       |          |       |          |       |          |       |
| ContiTech<br>4916 N1 P01   |                                |  |                          |                      |                               |  |   |              |              |               |       |          |       |          |       |          |       |          |       |
| GOODYEAR   |                                |  |                          |                      |                               |  |   |              |              |               |       |          |       |          |       |          |       |          |       |
| VIBRACOUSTIC   |                                |  |                          |                      |                               |  |   |              |              |               |       |          |       |          |       |          |       |          |       |
| Code   | Manufacturer                   |  |                          |                      |                               |  |   |              |              |               |       |          |       |          |       |          |       |          |       |
| 81.43600.6042  | MAN                            |  |                          |                      |                               |  |   |              |              |               |       |          |       |          |       |          |       |          |       |



# Towing vehicle & Trailer & Semitrailer Air Springs

| Code   | Section, Top View, Bottom View | Applications |                           |  |                          |  |          |  |                              |  |  |   |                      |   |               |              |               |     |
|--|--------------------------------|--------------|---------------------------|--|--------------------------|--|----------|--|------------------------------|--|--|---|----------------------|---|---------------|--------------|---------------|-----|
| <b>FM18028.H02 (Customized Product)</b>  |                                |              |                           |  |                          |  |          |  |                              |  |  |   |                      |   |               |              |               |     |
| <table border="1"> <tr> <td>Competitor code</td> <td></td> </tr> <tr> <td>Firestone</td> <td></td> </tr> <tr> <td>ContiTech</td> <td></td> </tr> <tr> <td>GOODYEAR</td> <td></td> </tr> <tr> <td>VIBRACOUSTIC</td> <td></td> </tr> <tr> <td colspan="2">FM18028.C02<br/>Service assembly<br/>for FM18028.C02</td> </tr> </table> | Competitor code                |              | Firestone                 |  | ContiTech                |  | GOODYEAR |  | VIBRACOUSTIC                 |  | FM18028.C02<br>Service assembly<br>for FM18028.C02 |   | <p>Piston: No</p>    | <table border="1"> <tr> <td>Code</td> <td>Manufacturer</td> </tr> <tr> <td></td> <td></td> </tr> </table>                 | Code          | Manufacturer |               |     |
| Competitor code  |                                |              |                           |  |                          |  |          |  |                              |  |  |   |                      |   |               |              |               |     |
| Firestone  |                                |              |                           |  |                          |  |          |  |                              |  |  |   |                      |   |               |              |               |     |
| ContiTech  |                                |              |                           |  |                          |  |          |  |                              |  |  |   |                      |   |               |              |               |     |
| GOODYEAR   |                                |              |                           |  |                          |  |          |  |                              |  |  |   |                      |   |               |              |               |     |
| VIBRACOUSTIC   |                                |              |                           |  |                          |  |          |  |                              |  |  |   |                      |   |               |              |               |     |
| FM18028.C02<br>Service assembly<br>for FM18028.C02   |                                |              |                           |  |                          |  |          |  |                              |  |  |   |                      |   |               |              |               |     |
| Code   | Manufacturer                   |              |                           |  |                          |  |          |  |                              |  |  |   |                      |   |               |              |               |     |
|  |                                |              |                           |  |                          |  |          |  |                              |  |  |   |                      |   |               |              |               |     |
| <b>FM18028.C01</b>   |                                |              |                           |  |                          |  |          |  |                              |  |  |   |                      |   |               |              |               |     |
| <table border="1"> <tr> <td>Competitor code</td> <td></td> </tr> <tr> <td>Firestone<br/>W01-M58-8356</td> <td></td> </tr> <tr> <td>ContiTech<br/>4916 N1 P07</td> <td></td> </tr> <tr> <td>GOODYEAR</td> <td></td> </tr> <tr> <td>VIBRACOUSTIC<br/>V 1 DF 26S-1</td> <td></td> </tr> </table>                                    | Competitor code                |              | Firestone<br>W01-M58-8356 |  | ContiTech<br>4916 N1 P07 |  | GOODYEAR |  | VIBRACOUSTIC<br>V 1 DF 26S-1 |  | <p>Piston: Steel</p>                               | <table border="1"> <tr> <td>Code</td> <td>Manufacturer</td> </tr> <tr> <td>81.43600.6042</td> <td>MAN</td> </tr> </table> | Code                 | Manufacturer  | 81.43600.6042 | MAN          |               |     |
| Competitor code  |                                |              |                           |  |                          |  |          |  |                              |  |  |   |                      |   |               |              |               |     |
| Firestone<br>W01-M58-8356  |                                |              |                           |  |                          |  |          |  |                              |  |  |   |                      |   |               |              |               |     |
| ContiTech<br>4916 N1 P07   |                                |              |                           |  |                          |  |          |  |                              |  |  |   |                      |   |               |              |               |     |
| GOODYEAR   |                                |              |                           |  |                          |  |          |  |                              |  |  |   |                      |   |               |              |               |     |
| VIBRACOUSTIC<br>V 1 DF 26S-1   |                                |              |                           |  |                          |  |          |  |                              |  |  |   |                      |   |               |              |               |     |
| Code   | Manufacturer                   |              |                           |  |                          |  |          |  |                              |  |  |   |                      |   |               |              |               |     |
| 81.43600.6042  | MAN                            |              |                           |  |                          |  |          |  |                              |  |  |   |                      |   |               |              |               |     |
| <b>FM18028.C02 (Customized Product)</b>  |                                |              |                           |  |                          |  |          |  |                              |  |  |   |                      |   |               |              |               |     |
| <table border="1"> <tr> <td>Competitor code</td> <td></td> </tr> <tr> <td>Firestone</td> <td></td> </tr> <tr> <td>ContiTech</td> <td></td> </tr> <tr> <td>GOODYEAR</td> <td></td> </tr> <tr> <td>VIBRACOUSTIC</td> <td></td> </tr> <tr> <td colspan="2">1V-4916A</td> </tr> </table>   | Competitor code                |              | Firestone                 |  | ContiTech                |  | GOODYEAR |  | VIBRACOUSTIC                 |  | 1V-4916A   |   | <p>Piston: Steel</p> | <table border="1"> <tr> <td>Code</td> <td>Manufacturer</td> </tr> <tr> <td>81.43600.6042</td> <td>MAN</td> </tr> </table> | Code          | Manufacturer | 81.43600.6042 | MAN |
| Competitor code  |                                |              |                           |  |                          |  |          |  |                              |  |  |   |                      |   |               |              |               |     |
| Firestone  |                                |              |                           |  |                          |  |          |  |                              |  |  |   |                      |   |               |              |               |     |
| ContiTech  |                                |              |                           |  |                          |  |          |  |                              |  |  |   |                      |   |               |              |               |     |
| GOODYEAR   |                                |              |                           |  |                          |  |          |  |                              |  |  |   |                      |   |               |              |               |     |
| VIBRACOUSTIC   |                                |              |                           |  |                          |  |          |  |                              |  |  |   |                      |   |               |              |               |     |
| 1V-4916A   |                                |              |                           |  |                          |  |          |  |                              |  |  |   |                      |   |               |              |               |     |
| Code   | Manufacturer                   |              |                           |  |                          |  |          |  |                              |  |  |   |                      |   |               |              |               |     |
| 81.43600.6042  | MAN                            |              |                           |  |                          |  |          |  |                              |  |  |   |                      |   |               |              |               |     |



# Towing vehicle & Trailer & Semitrailer Air Springs

| Code  | FM18031.H01     | Applications                           |                         |                      |                                  |  |   |      |              |               |     |               |     |               |     |
|---|-----------------|--|-------------------------|----------------------|----------------------------------|--|---|------|--------------|---------------|-----|---------------|-----|---------------|-----|
| <b>FM18028.C03 (Customized Product)</b>   |                 |  |                         |                      |                                  |  |   |      |              |               |     |               |     |               |     |
| <table border="1" style="width: 100%; border-collapse: collapse;"> <tr><td style="padding: 2px;">Competitor code</td></tr> <tr><td style="padding: 2px;">Firestone</td></tr> <tr><td style="padding: 2px;">ContiTech</td></tr> <tr><td style="padding: 2px;">GOODYEAR</td></tr> <tr><td style="padding: 2px;">VIBRACOUSTIC</td></tr> </table>   | Competitor code | Firestone                              | ContiTech               | GOODYEAR             | VIBRACOUSTIC                     | <p style="text-align: center;">Piston: Steel</p>     | <table border="1" style="width: 100%; border-collapse: collapse;"> <tr> <th style="width: 50%;">Code</th> <th style="width: 50%;">Manufacturer</th> </tr> <tr> <td style="height: 100px;"> </td> <td> </td> </tr> </table>  | Code | Manufacturer |               |     |               |     |               |     |
| Competitor code   |                 |  |                         |                      |                                  |  |   |      |              |               |     |               |     |               |     |
| Firestone   |                 |  |                         |                      |                                  |  |   |      |              |               |     |               |     |               |     |
| ContiTech   |                 |  |                         |                      |                                  |  |   |      |              |               |     |               |     |               |     |
| GOODYEAR  |                 |  |                         |                      |                                  |  |   |      |              |               |     |               |     |               |     |
| VIBRACOUSTIC  |                 |  |                         |                      |                                  |  |   |      |              |               |     |               |     |               |     |
| Code  | Manufacturer    |  |                         |                      |                                  |  |   |      |              |               |     |               |     |               |     |
|   |                 |  |                         |                      |                                  |  |   |      |              |               |     |               |     |               |     |
| <b>FM18028.C04 (Customized Product)</b>   |                 |  |                         |                      |                                  |  |   |      |              |               |     |               |     |               |     |
| <table border="1" style="width: 100%; border-collapse: collapse;"> <tr><td style="padding: 2px;">Competitor code</td></tr> <tr><td style="padding: 2px;">Firestone</td></tr> <tr><td style="padding: 2px;">ContiTech</td></tr> <tr><td style="padding: 2px;">GOODYEAR</td></tr> <tr><td style="padding: 2px;">VIBRACOUSTIC</td></tr> </table>   | Competitor code | Firestone                              | ContiTech               | GOODYEAR             | VIBRACOUSTIC                     | <p style="text-align: center;">Piston: Composite</p> | <table border="1" style="width: 100%; border-collapse: collapse;"> <tr> <th style="width: 50%;">Code</th> <th style="width: 50%;">Manufacturer</th> </tr> <tr> <td style="height: 100px;"> </td> <td> </td> </tr> </table>  | Code | Manufacturer |               |     |               |     |               |     |
| Competitor code   |                 |  |                         |                      |                                  |  |   |      |              |               |     |               |     |               |     |
| Firestone   |                 |  |                         |                      |                                  |  |   |      |              |               |     |               |     |               |     |
| ContiTech   |                 |  |                         |                      |                                  |  |   |      |              |               |     |               |     |               |     |
| GOODYEAR  |                 |  |                         |                      |                                  |  |   |      |              |               |     |               |     |               |     |
| VIBRACOUSTIC  |                 |  |                         |                      |                                  |  |   |      |              |               |     |               |     |               |     |
| Code  | Manufacturer    |  |                         |                      |                                  |  |   |      |              |               |     |               |     |               |     |
|   |                 |  |                         |                      |                                  |  |   |      |              |               |     |               |     |               |     |
| <b>FM18028.H01</b>  |                 |  |                         |                      |                                  |  |   |      |              |               |     |               |     |               |     |
| <table border="1" style="width: 100%; border-collapse: collapse;"> <tr><td style="padding: 2px;">Competitor code</td></tr> <tr><td style="padding: 2px;">Firestone<br/>1T17 BS-6<br/>W01-M58-0919</td></tr> <tr><td style="padding: 2px;">ContiTech<br/>4004 N P02</td></tr> <tr><td style="padding: 2px;">GOODYEAR<br/>1R11-705</td></tr> <tr><td style="padding: 2px;">VIBRACOUSTIC<br/>V 1 DK 22 E-5 NP</td></tr> </table> | Competitor code | Firestone<br>1T17 BS-6<br>W01-M58-0919 | ContiTech<br>4004 N P02 | GOODYEAR<br>1R11-705 | VIBRACOUSTIC<br>V 1 DK 22 E-5 NP | <p style="text-align: center;">Piston: No</p>        | <table border="1" style="width: 100%; border-collapse: collapse;"> <tr> <th style="width: 50%;">Code</th> <th style="width: 50%;">Manufacturer</th> </tr> <tr> <td style="padding: 2px;">3.229.0007.00</td> <td style="padding: 2px;">SAF</td> </tr> <tr> <td style="padding: 2px;">3.229.0007.01</td> <td style="padding: 2px;">SAF</td> </tr> <tr> <td style="padding: 2px;">3.229.0007.02</td> <td style="padding: 2px;">SAF</td> </tr> </table> | Code | Manufacturer | 3.229.0007.00 | SAF | 3.229.0007.01 | SAF | 3.229.0007.02 | SAF |
| Competitor code   |                 |  |                         |                      |                                  |  |   |      |              |               |     |               |     |               |     |
| Firestone<br>1T17 BS-6<br>W01-M58-0919  |                 |  |                         |                      |                                  |  |   |      |              |               |     |               |     |               |     |
| ContiTech<br>4004 N P02   |                 |  |                         |                      |                                  |  |   |      |              |               |     |               |     |               |     |
| GOODYEAR<br>1R11-705  |                 |  |                         |                      |                                  |  |   |      |              |               |     |               |     |               |     |
| VIBRACOUSTIC<br>V 1 DK 22 E-5 NP  |                 |  |                         |                      |                                  |  |   |      |              |               |     |               |     |               |     |
| Code  | Manufacturer    |  |                         |                      |                                  |  |   |      |              |               |     |               |     |               |     |
| 3.229.0007.00   | SAF             |  |                         |                      |                                  |  |   |      |              |               |     |               |     |               |     |
| 3.229.0007.01   | SAF             |  |                         |                      |                                  |  |   |      |              |               |     |               |     |               |     |
| 3.229.0007.02   | SAF             |  |                         |                      |                                  |  |   |      |              |               |     |               |     |               |     |



# Towing vehicle & Trailer & Semitrailer Air Springs

| Code  | Section, Top View, Bottom View | Applications                              |                         |                                |   |   |   |      |              |               |               |               |     |               |     |               |     |
|---|--------------------------------|---|-------------------------|--------------------------------|---|---|---|------|--------------|---------------|---------------|---------------|-----|---------------|-----|---------------|-----|
| <b>FM18031.H02</b>  |                                |   |                         |                                |   |   |   |      |              |               |               |               |     |               |     |               |     |
| <table border="1"> <tr> <td data-bbox="153 411 381 491">Competitor code</td> </tr> <tr> <td data-bbox="153 491 381 592">Firestone<br/>1T17 BS-6<br/>W01-M58-0756</td> </tr> <tr> <td data-bbox="153 592 381 672">ContiTech<br/>4022 N P02</td> </tr> <tr> <td data-bbox="153 672 381 774">GOODYEAR<br/>1R11-850 /1R11-709</td> </tr> <tr> <td data-bbox="153 774 381 935">VIBRACOUSTIC<br/>V 1 DK 22 E-9 NP<br/><br/>W01-M58-6367/4022 N<br/>P03 Service assembly for<br/>W01-M58-6367/4022 N<br/>P03</td> </tr> </table> | Competitor code                | Firestone<br>1T17 BS-6<br>W01-M58-0756    | ContiTech<br>4022 N P02 | GOODYEAR<br>1R11-850 /1R11-709 | VIBRACOUSTIC<br>V 1 DK 22 E-9 NP<br><br>W01-M58-6367/4022 N<br>P03 Service assembly for<br>W01-M58-6367/4022 N<br>P03 | <p style="text-align: center;">TOP VIEW</p> <p>Piston: No</p>   | <table border="1"> <thead> <tr> <th data-bbox="948 411 1177 482">Code</th> <th data-bbox="1177 411 1436 482">Manufacturer</th> </tr> </thead> <tbody> <tr> <td> </td> <td> </td> </tr> </tbody> </table>  |      | Code         | Manufacturer  |               |               |     |               |     |               |     |
| Competitor code   |                                |   |                         |                                |   |   |   |      |              |               |               |               |     |               |     |               |     |
| Firestone<br>1T17 BS-6<br>W01-M58-0756  |                                |   |                         |                                |   |   |   |      |              |               |               |               |     |               |     |               |     |
| ContiTech<br>4022 N P02   |                                |   |                         |                                |   |   |   |      |              |               |               |               |     |               |     |               |     |
| GOODYEAR<br>1R11-850 /1R11-709  |                                |   |                         |                                |   |   |   |      |              |               |               |               |     |               |     |               |     |
| VIBRACOUSTIC<br>V 1 DK 22 E-9 NP<br><br>W01-M58-6367/4022 N<br>P03 Service assembly for<br>W01-M58-6367/4022 N<br>P03   |                                |   |                         |                                |   |   |   |      |              |               |               |               |     |               |     |               |     |
| Code  | Manufacturer                   |   |                         |                                |   |   |   |      |              |               |               |               |     |               |     |               |     |
|   |                                |   |                         |                                |   |   |   |      |              |               |               |               |     |               |     |               |     |
| <b>FM18031.C01P</b>   |                                |   |                         |                                |   |   |   |      |              |               |               |               |     |               |     |               |     |
| <table border="1"> <tr> <td data-bbox="153 996 381 1078">Competitor code</td> </tr> <tr> <td data-bbox="153 1078 381 1179">Firestone<br/>1T17B SERIES<br/>W01-M58-6367</td> </tr> <tr> <td data-bbox="153 1179 381 1259">ContiTech<br/>4022 N P03</td> </tr> <tr> <td data-bbox="153 1259 381 1468">GOODYEAR<br/>1R11-714 /1R11-751</td> </tr> </table>   | Competitor code                | Firestone<br>1T17B SERIES<br>W01-M58-6367 | ContiTech<br>4022 N P03 | GOODYEAR<br>1R11-714 /1R11-751 | <p style="text-align: center;">TOP VIEW</p> <p>Piston: Composite</p>  | <table border="1"> <thead> <tr> <th data-bbox="948 996 1193 1041">Code</th> <th data-bbox="1193 996 1436 1041">Manufacturer</th> </tr> </thead> <tbody> <tr> <td data-bbox="948 1041 1193 1078">3.229.0029.00</td> <td data-bbox="1193 1041 1436 1078">SAF</td> </tr> <tr> <td data-bbox="948 1078 1193 1114">3.229.2129.00</td> <td data-bbox="1193 1078 1436 1114">SAF</td> </tr> <tr> <td data-bbox="948 1114 1193 1151">3.229.2229.00</td> <td data-bbox="1193 1114 1436 1151">SAF</td> </tr> <tr> <td data-bbox="948 1151 1193 1187">3.229.2429.00</td> <td data-bbox="1193 1151 1436 1187">SAF</td> </tr> </tbody> </table> |   | Code | Manufacturer | 3.229.0029.00 | SAF           | 3.229.2129.00 | SAF | 3.229.2229.00 | SAF | 3.229.2429.00 | SAF |
| Competitor code   |                                |   |                         |                                |   |   |   |      |              |               |               |               |     |               |     |               |     |
| Firestone<br>1T17B SERIES<br>W01-M58-6367   |                                |   |                         |                                |   |   |   |      |              |               |               |               |     |               |     |               |     |
| ContiTech<br>4022 N P03   |                                |   |                         |                                |   |   |   |      |              |               |               |               |     |               |     |               |     |
| GOODYEAR<br>1R11-714 /1R11-751  |                                |   |                         |                                |   |   |   |      |              |               |               |               |     |               |     |               |     |
| Code  | Manufacturer                   |   |                         |                                |   |   |   |      |              |               |               |               |     |               |     |               |     |
| 3.229.0029.00   | SAF                            |   |                         |                                |   |   |   |      |              |               |               |               |     |               |     |               |     |
| 3.229.2129.00   | SAF                            |   |                         |                                |   |   |   |      |              |               |               |               |     |               |     |               |     |
| 3.229.2229.00   | SAF                            |   |                         |                                |   |   |   |      |              |               |               |               |     |               |     |               |     |
| 3.229.2429.00   | SAF                            |   |                         |                                |   |   |   |      |              |               |               |               |     |               |     |               |     |
| <b>FM18031.C02P</b>   |                                |   |                         |                                |   |   |   |      |              |               |               |               |     |               |     |               |     |
| <table border="1"> <tr> <td data-bbox="153 1528 381 1608">Competitor code</td> </tr> <tr> <td data-bbox="153 1608 381 1709">Firestone<br/>1T17 BS-6<br/>W01-M58-8612</td> </tr> <tr> <td data-bbox="153 1709 381 1789">ContiTech<br/>4022 N P05</td> </tr> <tr> <td data-bbox="153 1789 381 1869">GOODYEAR<br/>1R11-781</td> </tr> <tr> <td data-bbox="153 1869 381 1989">VIBRACOUSTIC<br/>V 1 DK 22 E-10</td> </tr> </table>   | Competitor code                | Firestone<br>1T17 BS-6<br>W01-M58-8612    | ContiTech<br>4022 N P05 | GOODYEAR<br>1R11-781           | VIBRACOUSTIC<br>V 1 DK 22 E-10  | <p style="text-align: center;">TOP VIEW</p> <p>Piston: Composite</p>  | <table border="1"> <thead> <tr> <th data-bbox="948 1528 1193 1573">Code</th> <th data-bbox="1193 1528 1436 1573">Manufacturer</th> </tr> </thead> <tbody> <tr> <td data-bbox="948 1573 1193 1610">3.229.0033.00</td> <td data-bbox="1193 1573 1436 1610">SAF</td> </tr> </tbody> </table> |      | Code         | Manufacturer  | 3.229.0033.00 | SAF           |     |               |     |               |     |
| Competitor code   |                                |   |                         |                                |   |   |   |      |              |               |               |               |     |               |     |               |     |
| Firestone<br>1T17 BS-6<br>W01-M58-8612  |                                |   |                         |                                |   |   |   |      |              |               |               |               |     |               |     |               |     |
| ContiTech<br>4022 N P05   |                                |   |                         |                                |   |   |   |      |              |               |               |               |     |               |     |               |     |
| GOODYEAR<br>1R11-781  |                                |   |                         |                                |   |   |   |      |              |               |               |               |     |               |     |               |     |
| VIBRACOUSTIC<br>V 1 DK 22 E-10  |                                |   |                         |                                |   |   |   |      |              |               |               |               |     |               |     |               |     |
| Code  | Manufacturer                   |   |                         |                                |   |   |   |      |              |               |               |               |     |               |     |               |     |
| 3.229.0033.00   | SAF                            |   |                         |                                |   |   |   |      |              |               |               |               |     |               |     |               |     |



# Towing vehicle & Trailer & Semitrailer Air Springs

| Code   | Section, Top View, Bottom View | Applications                           |                         |                                   |                               |   |   |              |                |               |         |               |     |               |     |
|--|--------------------------------|--|-------------------------|-----------------------------------|-------------------------------|---|---|--------------|----------------|---------------|---------|---------------|-----|---------------|-----|
| <b>FM18031.C03P</b>  |                                |  |                         |                                   |                               |   |   |              |                |               |         |               |     |               |     |
| <table border="1"> <tr> <td>Competitor code</td> </tr> <tr> <td>Firestone<br/>1T17 BS-6<br/>W01-M58-6366</td> </tr> <tr> <td>ContiTech<br/>4004 N P03</td> </tr> <tr> <td>GOODYEAR<br/>1R11-713;<br/>1R11-750</td> </tr> <tr> <td>VIBRACOUSTIC<br/>V 1 DK 22 E-8</td> </tr> </table> | Competitor code                | Firestone<br>1T17 BS-6<br>W01-M58-6366 | ContiTech<br>4004 N P03 | GOODYEAR<br>1R11-713;<br>1R11-750 | VIBRACOUSTIC<br>V 1 DK 22 E-8 | <p>Piston: Composite</p>  | <table border="1"> <thead> <tr> <th>Code</th> <th>Manufacturer</th> </tr> </thead> <tbody> <tr> <td>3.229.0007.00</td> <td>SAF</td> </tr> <tr> <td>3.229.0007.01</td> <td>SAF</td> </tr> <tr> <td>3.229.0007.02</td> <td>SAF</td> </tr> </tbody> </table> | Code         | Manufacturer   | 3.229.0007.00 | SAF     | 3.229.0007.01 | SAF | 3.229.0007.02 | SAF |
| Competitor code  |                                |  |                         |                                   |                               |   |   |              |                |               |         |               |     |               |     |
| Firestone<br>1T17 BS-6<br>W01-M58-6366   |                                |  |                         |                                   |                               |   |   |              |                |               |         |               |     |               |     |
| ContiTech<br>4004 N P03  |                                |  |                         |                                   |                               |   |   |              |                |               |         |               |     |               |     |
| GOODYEAR<br>1R11-713;<br>1R11-750  |                                |  |                         |                                   |                               |   |   |              |                |               |         |               |     |               |     |
| VIBRACOUSTIC<br>V 1 DK 22 E-8  |                                |  |                         |                                   |                               |   |   |              |                |               |         |               |     |               |     |
| Code   | Manufacturer                   |  |                         |                                   |                               |   |   |              |                |               |         |               |     |               |     |
| 3.229.0007.00  | SAF                            |  |                         |                                   |                               |   |   |              |                |               |         |               |     |               |     |
| 3.229.0007.01  | SAF                            |  |                         |                                   |                               |   |   |              |                |               |         |               |     |               |     |
| 3.229.0007.02  | SAF                            |  |                         |                                   |                               |   |   |              |                |               |         |               |     |               |     |
| <b>FM18032.C01</b>   |                                |  |                         |                                   |                               |   |   |              |                |               |         |               |     |               |     |
| <table border="1"> <tr> <td>Competitor code</td> </tr> <tr> <td>Firestone<br/>W01-M58-6032</td> </tr> <tr> <td>ContiTech</td> </tr> <tr> <td>GOODYEAR</td> </tr> <tr> <td>VIBRACOUSTIC</td> </tr> </table>   | Competitor code                | Firestone<br>W01-M58-6032              | ContiTech               | GOODYEAR                          | VIBRACOUSTIC                  | <p>Piston: Composite</p>  | <table border="1"> <thead> <tr> <th>Code</th> <th>Manufacturer</th> </tr> </thead> <tbody> <tr> <td> </td> <td> </td> </tr> </tbody> </table>   | Code         | Manufacturer   |               |         |               |     |               |     |
| Competitor code  |                                |  |                         |                                   |                               |   |   |              |                |               |         |               |     |               |     |
| Firestone<br>W01-M58-6032  |                                |  |                         |                                   |                               |   |   |              |                |               |         |               |     |               |     |
| ContiTech  |                                |  |                         |                                   |                               |   |   |              |                |               |         |               |     |               |     |
| GOODYEAR   |                                |  |                         |                                   |                               |   |   |              |                |               |         |               |     |               |     |
| VIBRACOUSTIC   |                                |  |                         |                                   |                               |   |   |              |                |               |         |               |     |               |     |
| Code   | Manufacturer                   |  |                         |                                   |                               |   |   |              |                |               |         |               |     |               |     |
|  |                                |  |                         |                                   |                               |   |   |              |                |               |         |               |     |               |     |
| <b>FM18034.H01</b>   |                                |  |                         |                                   |                               |   |   |              |                |               |         |               |     |               |     |
| <table border="1"> <tr> <td>Competitor code</td> </tr> <tr> <td>Firestone<br/>1T66F-7.0<br/>W01-M58-8601</td> </tr> <tr> <td>ContiTech<br/>4881 N P02</td> </tr> <tr> <td>GOODYEAR<br/>1R14-701</td> </tr> </table>  | Competitor code                | Firestone<br>1T66F-7.0<br>W01-M58-8601 | ContiTech<br>4881 N P02 | GOODYEAR<br>1R14-701              | <p>Piston: No</p>             | <table border="1"> <thead> <tr> <th>Code</th> <th>Manufacturer</th> </tr> </thead> <tbody> <tr> <td>05.429.41.01.0</td> <td>BPW 36K</td> </tr> <tr> <td>750 570</td> <td>Schmitz</td> </tr> </tbody> </table> | Code  | Manufacturer | 05.429.41.01.0 | BPW 36K       | 750 570 | Schmitz       |     |               |     |
| Competitor code  |                                |  |                         |                                   |                               |   |   |              |                |               |         |               |     |               |     |
| Firestone<br>1T66F-7.0<br>W01-M58-8601   |                                |  |                         |                                   |                               |   |   |              |                |               |         |               |     |               |     |
| ContiTech<br>4881 N P02  |                                |  |                         |                                   |                               |   |   |              |                |               |         |               |     |               |     |
| GOODYEAR<br>1R14-701   |                                |  |                         |                                   |                               |   |   |              |                |               |         |               |     |               |     |
| Code   | Manufacturer                   |  |                         |                                   |                               |   |   |              |                |               |         |               |     |               |     |
| 05.429.41.01.0   | BPW 36K                        |  |                         |                                   |                               |   |   |              |                |               |         |               |     |               |     |
| 750 570  | Schmitz                        |  |                         |                                   |                               |   |   |              |                |               |         |               |     |               |     |



# Towing vehicle & Trailer & Semitrailer Air Springs

| Code                                    | Section, Top View, Bottom View | Applications           |                         |
|---|--------------------------------|------------------------|-------------------------|
| <b>FM18034.C01</b>                      |                                |                        |                         |
| Competitor code                         |                                | Code<br>05.429.41.31.1 | Manufacturer<br>BPW 36K |
| Firestone<br>1T66 F-7.0<br>W01-M58-8602 |                                |                        |                         |
| ContiTech<br>4881 N P30                 |                                |                        |                         |
| GOODYEAR<br>1R14-757                    |                                |                        |                         |
| Piston: Steel                           |                                |                        |                         |
| <b>FM18034.C02 (Customized Product)</b> |                                |                        |                         |
| Competitor code                         |                                | Code                   | Manufacturer            |
| Firestone                               |                                |                        |                         |
| ContiTech                               |                                |                        |                         |
| GOODYEAR<br>1R14-757                    |                                |                        |                         |
| 481D                                    | Piston: Steel                  |                        |                         |
| <b>FM18031.C02P</b>                     |                                |                        |                         |
| Competitor code                         |                                | Code<br>05.429.43.41.0 | Manufacturer<br>BPW     |
| Firestone<br>1T66F-7.0<br>W01-M58-8666  |                                | 6-AB8003-0200          | HUFFERMANN              |
| ContiTech<br>4881 N P30                 |                                | 750 491                | SCHMITZ                 |
| GOODYEAR<br>1R14-757                    |                                | 751 356                | SCHMITZ                 |
| Piston: Composite                       |                                | 2198331                | SCANIA                  |



# Towing vehicle & Trailer & Semitrailer Air Springs

| Code  | Section, Top View, Bottom View | Applications                            |                         |                      |  |                          |   |  |      |              |                    |         |                       |         |         |        |
|---|--------------------------------|---|-------------------------|----------------------|--|--------------------------|---|--|------|--------------|--------------------|---------|-----------------------|---------|---------|--------|
| <b>FM18035.H01</b>  |                                |   |                         |                      |  |                          |   |  |      |              |                    |         |                       |         |         |        |
| <table border="1"> <tr> <td>Competitor code</td> </tr> <tr> <td>Firestone<br/>1T15 MPW-9<br/>W01-M58-6257</td> </tr> <tr> <td>ContiTech<br/>4158 N P02</td> </tr> <tr> <td>GOODYEAR<br/>1R12-748</td> </tr> <tr> <td>VIBRACOUSTIC<br/>V 1 DK 20 B-1 NP<br/>W01-M58-8185</td> </tr> </table> | Competitor code                | Firestone<br>1T15 MPW-9<br>W01-M58-6257 | ContiTech<br>4158 N P02 | GOODYEAR<br>1R12-748 | VIBRACOUSTIC<br>V 1 DK 20 B-1 NP<br>W01-M58-8185 | <p>Piston: No</p>        | <table border="1"> <thead> <tr> <th>Code</th> <th>Manufacturer</th> </tr> </thead> <tbody> <tr> <td>750 999</td> <td>SCHMITZ</td> </tr> <tr> <td>US 06285F</td> <td>WEWELER</td> </tr> </tbody> </table>  |  | Code | Manufacturer | 750 999            | SCHMITZ | US 06285F             | WEWELER |         |        |
| Competitor code   |                                |   |                         |                      |  |                          |   |  |      |              |                    |         |                       |         |         |        |
| Firestone<br>1T15 MPW-9<br>W01-M58-6257   |                                |   |                         |                      |  |                          |   |  |      |              |                    |         |                       |         |         |        |
| ContiTech<br>4158 N P02   |                                |   |                         |                      |  |                          |   |  |      |              |                    |         |                       |         |         |        |
| GOODYEAR<br>1R12-748  |                                |   |                         |                      |  |                          |   |  |      |              |                    |         |                       |         |         |        |
| VIBRACOUSTIC<br>V 1 DK 20 B-1 NP<br>W01-M58-8185  |                                |   |                         |                      |  |                          |   |  |      |              |                    |         |                       |         |         |        |
| Code  | Manufacturer                   |   |                         |                      |  |                          |   |  |      |              |                    |         |                       |         |         |        |
| 750 999   | SCHMITZ                        |   |                         |                      |  |                          |   |  |      |              |                    |         |                       |         |         |        |
| US 06285F   | WEWELER                        |   |                         |                      |  |                          |   |  |      |              |                    |         |                       |         |         |        |
| <b>FM18035.C01</b>  |                                |   |                         |                      |  |                          |   |  |      |              |                    |         |                       |         |         |        |
| <table border="1"> <tr> <td>Competitor code</td> </tr> <tr> <td>Firestone<br/>1T15 MPW-9<br/>W01-M58-8185</td> </tr> <tr> <td>ContiTech<br/>4158 N P03</td> </tr> <tr> <td>GOODYEAR<br/>1R12-749</td> </tr> <tr> <td>VIBRACOUSTIC<br/>V 1 DK 20 B-1</td> </tr> </table>                     | Competitor code                | Firestone<br>1T15 MPW-9<br>W01-M58-8185 | ContiTech<br>4158 N P03 | GOODYEAR<br>1R12-749 | VIBRACOUSTIC<br>V 1 DK 20 B-1                    | <p>Piston: Composite</p> | <table border="1"> <thead> <tr> <th>Code</th> <th>Manufacturer</th> </tr> </thead> <tbody> <tr> <td>750 999<br/>014 892</td> <td>SCHMITZ</td> </tr> <tr> <td>US 06285<br/>US 06285F</td> <td>WEWELER</td> </tr> <tr> <td>2198334</td> <td>Scania</td> </tr> </tbody> </table> |  | Code | Manufacturer | 750 999<br>014 892 | SCHMITZ | US 06285<br>US 06285F | WEWELER | 2198334 | Scania |
| Competitor code   |                                |   |                         |                      |  |                          |   |  |      |              |                    |         |                       |         |         |        |
| Firestone<br>1T15 MPW-9<br>W01-M58-8185   |                                |   |                         |                      |  |                          |   |  |      |              |                    |         |                       |         |         |        |
| ContiTech<br>4158 N P03   |                                |   |                         |                      |  |                          |   |  |      |              |                    |         |                       |         |         |        |
| GOODYEAR<br>1R12-749  |                                |   |                         |                      |  |                          |   |  |      |              |                    |         |                       |         |         |        |
| VIBRACOUSTIC<br>V 1 DK 20 B-1   |                                |   |                         |                      |  |                          |   |  |      |              |                    |         |                       |         |         |        |
| Code  | Manufacturer                   |   |                         |                      |  |                          |   |  |      |              |                    |         |                       |         |         |        |
| 750 999<br>014 892  | SCHMITZ                        |   |                         |                      |  |                          |   |  |      |              |                    |         |                       |         |         |        |
| US 06285<br>US 06285F   | WEWELER                        |   |                         |                      |  |                          |   |  |      |              |                    |         |                       |         |         |        |
| 2198334   | Scania                         |   |                         |                      |  |                          |   |  |      |              |                    |         |                       |         |         |        |
| <b>FM18037.H01</b>  |                                |   |                         |                      |  |                          |   |  |      |              |                    |         |                       |         |         |        |
| <table border="1"> <tr> <td>Competitor code</td> </tr> <tr> <td>Firestone</td> </tr> <tr> <td>ContiTech<br/>4982 N1</td> </tr> <tr> <td>GOODYEAR<br/>1R12-749</td> </tr> <tr> <td>VIBRACOUSTIC<br/>V 1 DK 20 B-1</td> </tr> </table>  | Competitor code                | Firestone                               | ContiTech<br>4982 N1    | GOODYEAR<br>1R12-749 | VIBRACOUSTIC<br>V 1 DK 20 B-1                    | <p>Piston: No</p>        | <table border="1"> <thead> <tr> <th>Code</th> <th>Manufacturer</th> </tr> </thead> <tbody> <tr> <td> </td> <td> </td> </tr> </tbody> </table>   |  | Code | Manufacturer |                    |         |                       |         |         |        |
| Competitor code   |                                |   |                         |                      |  |                          |   |  |      |              |                    |         |                       |         |         |        |
| Firestone   |                                |   |                         |                      |  |                          |   |  |      |              |                    |         |                       |         |         |        |
| ContiTech<br>4982 N1  |                                |   |                         |                      |  |                          |   |  |      |              |                    |         |                       |         |         |        |
| GOODYEAR<br>1R12-749  |                                |   |                         |                      |  |                          |   |  |      |              |                    |         |                       |         |         |        |
| VIBRACOUSTIC<br>V 1 DK 20 B-1   |                                |   |                         |                      |  |                          |   |  |      |              |                    |         |                       |         |         |        |
| Code  | Manufacturer                   |   |                         |                      |  |                          |   |  |      |              |                    |         |                       |         |         |        |
|   |                                |   |                         |                      |  |                          |   |  |      |              |                    |         |                       |         |         |        |



# Towing vehicle & Trailer & Semitrailer Air Springs

| Code   | Section, Top View, Bottom View | Applications  |              |
|--|--------------------------------|---------------|--------------|
| <b>FM18037.C01</b>                                     |                                |               |              |
| Competitor code  |                                | Code          | Manufacturer |
| Firestone  |                                |               |              |
| ContiTech<br>4982 N1 P05                               |                                |               |              |
| GOODYEAR   |                                |               |              |
| VIBRACOUSTIC   |                                |               |              |
| Piston: Composite                                      |                                |               |              |
| <b>FM18038.H01</b>                                     |                                |               |              |
| Competitor code  |                                | Code          | Manufacturer |
| Firestone  |                                | 81.43601.0173 | MAN          |
| ContiTech<br>4984 N1                                   |                                |               |              |
| GOODYEAR   |                                |               |              |
| VIBRACOUSTIC   |                                |               |              |
| Piston: No   |                                |               |              |
| <b>FM18038.C01</b>                                     |                                |               |              |
| Competitor code  |                                | Code          | Manufacturer |
| Firestone<br>1T17JR7.2<br>W01-M58-8360<br>W01-M58-9879 |                                | 81.43600.6035 | MAN          |
| ContiTech<br>4984 N1 P06                               |                                | 81.43600.6055 | MAN          |
| VIBRACOUSTIC<br>V 1 DF 21S-<br>490606                  |                                |               | FAW          |
| GOODYEAR<br>1R11-861                                   |                                |               | SHACMAN      |
|  |                                |               | CNHTC        |
| Piston: Steel  |                                |               |              |



# Towing vehicle & Trailer & Semitrailer Air Springs

| Code  | Section, Top View, Bottom View | Applications                             |                          |              |                      |  |   |   |              |               |     |  |     |  |         |  |       |
|---|--------------------------------|--|--------------------------|--------------|----------------------|--|---|---|--------------|---------------|-----|--|-----|--|---------|--|-------|
| <b>FM18038.C02</b>  |                                |  |                          |              |                      |  |   |   |              |               |     |  |     |  |         |  |       |
| <table border="1"> <tr> <td>Competitor code</td> </tr> <tr> <td>Firestone<br/>1T17JBR-8.0<br/>W01-M58-8358</td> </tr> <tr> <td>ContiTech<br/>4984 N1 P07</td> </tr> <tr> <td>VIBRACOUSTIC</td> </tr> <tr> <td>GOODYEAR<br/>1R11-885</td> </tr> </table>                       | Competitor code                | Firestone<br>1T17JBR-8.0<br>W01-M58-8358 | ContiTech<br>4984 N1 P07 | VIBRACOUSTIC | GOODYEAR<br>1R11-885 | <p>Piston: Steel</p>                               | <table border="1"> <thead> <tr> <th>Code</th> <th>Manufacturer</th> </tr> </thead> <tbody> <tr> <td>81.43600.6041</td> <td>MAN</td> </tr> <tr> <td></td> <td>FAW</td> </tr> <tr> <td></td> <td>SHACMAN</td> </tr> <tr> <td></td> <td>CNHTC</td> </tr> </tbody> </table> | Code  | Manufacturer | 81.43600.6041 | MAN |  | FAW |  | SHACMAN |  | CNHTC |
| Competitor code   |                                |  |                          |              |                      |  |   |   |              |               |     |  |     |  |         |  |       |
| Firestone<br>1T17JBR-8.0<br>W01-M58-8358  |                                |  |                          |              |                      |  |   |   |              |               |     |  |     |  |         |  |       |
| ContiTech<br>4984 N1 P07  |                                |  |                          |              |                      |  |   |   |              |               |     |  |     |  |         |  |       |
| VIBRACOUSTIC  |                                |  |                          |              |                      |  |   |   |              |               |     |  |     |  |         |  |       |
| GOODYEAR<br>1R11-885  |                                |  |                          |              |                      |  |   |   |              |               |     |  |     |  |         |  |       |
| Code  | Manufacturer                   |  |                          |              |                      |  |   |   |              |               |     |  |     |  |         |  |       |
| 81.43600.6041   | MAN                            |  |                          |              |                      |  |   |   |              |               |     |  |     |  |         |  |       |
|   | FAW                            |  |                          |              |                      |  |   |   |              |               |     |  |     |  |         |  |       |
|   | SHACMAN                        |  |                          |              |                      |  |   |   |              |               |     |  |     |  |         |  |       |
|   | CNHTC                          |  |                          |              |                      |  |   |   |              |               |     |  |     |  |         |  |       |
| <b>FM18039.H01</b>  |                                |  |                          |              |                      |  |   |   |              |               |     |  |     |  |         |  |       |
| <table border="1"> <tr> <td>Competitor code</td> </tr> <tr> <td>Firestone</td> </tr> <tr> <td>ContiTech<br/>8102 N</td> </tr> <tr> <td>GOODYEAR</td> </tr> <tr> <td>VIBRACOUSTIC</td> </tr> <tr> <td>FM18039.C01<br/>Service assembly for<br/>FM18039.C01</td> </tr> </table> | Competitor code                | Firestone                                | ContiTech<br>8102 N      | GOODYEAR     | VIBRACOUSTIC         | FM18039.C01<br>Service assembly for<br>FM18039.C01 | <p>Piston: No</p>   | <table border="1"> <thead> <tr> <th>Code</th> <th>Manufacturer</th> </tr> </thead> <tbody> <tr> <td></td> <td></td> </tr> </tbody> </table> | Code         | Manufacturer  |     |  |     |  |         |  |       |
| Competitor code   |                                |  |                          |              |                      |  |   |   |              |               |     |  |     |  |         |  |       |
| Firestone   |                                |  |                          |              |                      |  |   |   |              |               |     |  |     |  |         |  |       |
| ContiTech<br>8102 N   |                                |  |                          |              |                      |  |   |   |              |               |     |  |     |  |         |  |       |
| GOODYEAR  |                                |  |                          |              |                      |  |   |   |              |               |     |  |     |  |         |  |       |
| VIBRACOUSTIC  |                                |  |                          |              |                      |  |   |   |              |               |     |  |     |  |         |  |       |
| FM18039.C01<br>Service assembly for<br>FM18039.C01  |                                |  |                          |              |                      |  |   |   |              |               |     |  |     |  |         |  |       |
| Code  | Manufacturer                   |  |                          |              |                      |  |   |   |              |               |     |  |     |  |         |  |       |
|   |                                |  |                          |              |                      |  |   |   |              |               |     |  |     |  |         |  |       |
| <b>FM18039.H02</b>  |                                |  |                          |              |                      |  |   |   |              |               |     |  |     |  |         |  |       |
| <table border="1"> <tr> <td>Competitor code</td> </tr> <tr> <td>Firestone</td> </tr> <tr> <td>ContiTech<br/>8102 N</td> </tr> <tr> <td>GOODYEAR</td> </tr> <tr> <td>VIBRACOUSTIC</td> </tr> <tr> <td>FM18039.C02<br/>Service assembly for<br/>FM18039.C02</td> </tr> </table> | Competitor code                | Firestone                                | ContiTech<br>8102 N      | GOODYEAR     | VIBRACOUSTIC         | FM18039.C02<br>Service assembly for<br>FM18039.C02 | <p>Piston: No</p>   | <table border="1"> <thead> <tr> <th>Code</th> <th>Manufacturer</th> </tr> </thead> <tbody> <tr> <td></td> <td></td> </tr> </tbody> </table> | Code         | Manufacturer  |     |  |     |  |         |  |       |
| Competitor code   |                                |  |                          |              |                      |  |   |   |              |               |     |  |     |  |         |  |       |
| Firestone   |                                |  |                          |              |                      |  |   |   |              |               |     |  |     |  |         |  |       |
| ContiTech<br>8102 N   |                                |  |                          |              |                      |  |   |   |              |               |     |  |     |  |         |  |       |
| GOODYEAR  |                                |  |                          |              |                      |  |   |   |              |               |     |  |     |  |         |  |       |
| VIBRACOUSTIC  |                                |  |                          |              |                      |  |   |   |              |               |     |  |     |  |         |  |       |
| FM18039.C02<br>Service assembly for<br>FM18039.C02  |                                |  |                          |              |                      |  |   |   |              |               |     |  |     |  |         |  |       |
| Code  | Manufacturer                   |  |                          |              |                      |  |   |   |              |               |     |  |     |  |         |  |       |
|   |                                |  |                          |              |                      |  |   |   |              |               |     |  |     |  |         |  |       |



# Towing vehicle & Trailer & Semitrailer Air Springs

| Code                      | Section, Top View, Bottom View | Applications         |                     |
|---------------------------|--------------------------------|----------------------|---------------------|
| <b>FM18039.C01</b>        |                                |                      |                     |
| Competitor code           |                                | Code<br>2935010Y8020 | Manufacturer<br>JAC |
| Firestone                 |                                |                      |                     |
| ContiTech<br>8102 N1      |                                |                      |                     |
| GOODYEAR                  |                                |                      |                     |
| VIBRACOUSTIC              |                                |                      |                     |
| Piston: Steel             |                                |                      |                     |
| <b>FM18039.C02</b>        |                                |                      |                     |
| Competitor code           |                                | Code                 | Manufacturer        |
| Firestone                 |                                |                      |                     |
| ContiTech                 |                                |                      |                     |
| GOODYEAR                  |                                |                      |                     |
| VIBRACOUSTIC<br>8102A     |                                |                      |                     |
| Piston: Steel             |                                |                      |                     |
| <b>FM18040.C01A</b>       |                                |                      |                     |
| Competitor code           |                                | Code                 | Manufacturer        |
| Firestone<br>W01-M58-9039 |                                |                      |                     |
| ContiTech                 |                                |                      |                     |
| GOODYEAR                  |                                |                      |                     |
| VIBRACOUSTIC              |                                |                      |                     |
| Piston: Aluminum          |                                |                      |                     |



# Towing vehicle & Trailer & Semitrailer Air Springs

| Code   | Section, Top View, Bottom View | Applications |              |
|--|--------------------------------|--------------|--------------|
| <b>FM18041.C01</b>   |                                |              |              |
| Competitor code  | <p>Piston: Steel</p>           | Code         | Manufacturer |
| Firestone<br>W01-M58-6368  |                                |              |              |
| ContiTech  |                                |              |              |
| GOODYEAR   |                                |              |              |
| VIBRACOUSTIC   |                                |              |              |
| <b>FM18041.C02A</b>  |                                |              |              |
| Competitor code  | <p>Piston: Aluminum</p>        | Code         | Manufacturer |
| Firestone<br>W01-M58-6413  |                                |              |              |
| ContiTech  |                                |              |              |
| GOODYEAR   |                                |              |              |
| VIBRACOUSTIC   |                                |              |              |
| <b>FM18042.H01</b>   |                                |              |              |
| Competitor code  | <p>Piston: No</p>              | Code         | Manufacturer |
| Firestone  |                                |              |              |
| ContiTech  |                                |              |              |
| GOODYEAR   |                                |              |              |
| VIBRACOUSTIC<br><br>FM18042.C01<br>Service assembly for<br>FM18042.C01 |                                |              |              |



# Towing vehicle & Trailer & Semitrailer Air Springs

| Code  | Section, Top View, Bottom View | Applications                          |                         |                      |                             |                         |   |  |      |              |              |          |  |             |  |       |  |     |  |     |  |         |
|---|--------------------------------|---------------------------------------|-------------------------|----------------------|-----------------------------|-------------------------|---|--|------|--------------|--------------|----------|--|-------------|--|-------|--|-----|--|-----|--|---------|
| <b>FM18042.C01</b>  |                                |                                       |                         |                      |                             |                         |   |  |      |              |              |          |  |             |  |       |  |     |  |     |  |         |
| <table border="1"> <tr> <td>Competitor code</td> </tr> <tr> <td>Firestone<br/>W01-358-8603</td> </tr> <tr> <td>ContiTech</td> </tr> <tr> <td>GOODYEAR</td> </tr> <tr> <td>VIBRACOUSTIC</td> </tr> </table>  | Competitor code                | Firestone<br>W01-358-8603             | ContiTech               | GOODYEAR             | VIBRACOUSTIC                | <p>Piston: Steel</p>    | <table border="1"> <tr> <th>Code</th> <th>Manufacturer</th> </tr> <tr> <td>2935010Y8020</td> <td>JAC</td> </tr> </table>  |  | Code | Manufacturer | 2935010Y8020 | JAC      |  |             |  |       |  |     |  |     |  |         |
| Competitor code   |                                |                                       |                         |                      |                             |                         |   |  |      |              |              |          |  |             |  |       |  |     |  |     |  |         |
| Firestone<br>W01-358-8603   |                                |                                       |                         |                      |                             |                         |   |  |      |              |              |          |  |             |  |       |  |     |  |     |  |         |
| ContiTech   |                                |                                       |                         |                      |                             |                         |   |  |      |              |              |          |  |             |  |       |  |     |  |     |  |         |
| GOODYEAR  |                                |                                       |                         |                      |                             |                         |   |  |      |              |              |          |  |             |  |       |  |     |  |     |  |         |
| VIBRACOUSTIC  |                                |                                       |                         |                      |                             |                         |   |  |      |              |              |          |  |             |  |       |  |     |  |     |  |         |
| Code  | Manufacturer                   |                                       |                         |                      |                             |                         |   |  |      |              |              |          |  |             |  |       |  |     |  |     |  |         |
| 2935010Y8020  | JAC                            |                                       |                         |                      |                             |                         |   |  |      |              |              |          |  |             |  |       |  |     |  |     |  |         |
| <b>FM18042.C02A</b>   |                                |                                       |                         |                      |                             |                         |   |  |      |              |              |          |  |             |  |       |  |     |  |     |  |         |
| <table border="1"> <tr> <td>Competitor code</td> </tr> <tr> <td>Firestone<br/>W01-358-8266</td> </tr> <tr> <td>ContiTech</td> </tr> <tr> <td>GOODYEAR<br/>1R13-155</td> </tr> <tr> <td>VIBRACOUSTIC<br/>1 V 17 BS-6</td> </tr> </table>             | Competitor code                | Firestone<br>W01-358-8266             | ContiTech               | GOODYEAR<br>1R13-155 | VIBRACOUSTIC<br>1 V 17 BS-6 | <p>Piston: Aluminum</p> | <table border="1"> <tr> <th>Code</th> <th>Manufacturer</th> </tr> <tr> <td></td> <td></td> </tr> </table>   |  | Code | Manufacturer |              |          |  |             |  |       |  |     |  |     |  |         |
| Competitor code   |                                |                                       |                         |                      |                             |                         |   |  |      |              |              |          |  |             |  |       |  |     |  |     |  |         |
| Firestone<br>W01-358-8266   |                                |                                       |                         |                      |                             |                         |   |  |      |              |              |          |  |             |  |       |  |     |  |     |  |         |
| ContiTech   |                                |                                       |                         |                      |                             |                         |   |  |      |              |              |          |  |             |  |       |  |     |  |     |  |         |
| GOODYEAR<br>1R13-155  |                                |                                       |                         |                      |                             |                         |   |  |      |              |              |          |  |             |  |       |  |     |  |     |  |         |
| VIBRACOUSTIC<br>1 V 17 BS-6   |                                |                                       |                         |                      |                             |                         |   |  |      |              |              |          |  |             |  |       |  |     |  |     |  |         |
| Code  | Manufacturer                   |                                       |                         |                      |                             |                         |   |  |      |              |              |          |  |             |  |       |  |     |  |     |  |         |
|   |                                |                                       |                         |                      |                             |                         |   |  |      |              |              |          |  |             |  |       |  |     |  |     |  |         |
| <b>FM18043.H</b>  |                                |                                       |                         |                      |                             |                         |   |  |      |              |              |          |  |             |  |       |  |     |  |     |  |         |
| <table border="1"> <tr> <td>Competitor code</td> </tr> <tr> <td>Firestone<br/>1T15 M-6<br/>W01-358-0734</td> </tr> <tr> <td>ContiTech<br/>4156 N P05</td> </tr> <tr> <td>GOODYEAR<br/>1R12-842</td> </tr> <tr> <td>VIBRACOUSTIC</td> </tr> </table> | Competitor code                | Firestone<br>1T15 M-6<br>W01-358-0734 | ContiTech<br>4156 N P05 | GOODYEAR<br>1R12-842 | VIBRACOUSTIC                | <p>Piston: No</p>       | <table border="1"> <tr> <th>Code</th> <th>Manufacturer</th> </tr> <tr> <td></td> <td>FRUEHAUF</td> </tr> <tr> <td></td> <td>HENDRICKSON</td> </tr> <tr> <td></td> <td>NEWAY</td> </tr> <tr> <td></td> <td>ROR</td> </tr> <tr> <td></td> <td>SMB</td> </tr> <tr> <td></td> <td>WEWELER</td> </tr> </table> |  | Code | Manufacturer |              | FRUEHAUF |  | HENDRICKSON |  | NEWAY |  | ROR |  | SMB |  | WEWELER |
| Competitor code   |                                |                                       |                         |                      |                             |                         |   |  |      |              |              |          |  |             |  |       |  |     |  |     |  |         |
| Firestone<br>1T15 M-6<br>W01-358-0734   |                                |                                       |                         |                      |                             |                         |   |  |      |              |              |          |  |             |  |       |  |     |  |     |  |         |
| ContiTech<br>4156 N P05   |                                |                                       |                         |                      |                             |                         |   |  |      |              |              |          |  |             |  |       |  |     |  |     |  |         |
| GOODYEAR<br>1R12-842  |                                |                                       |                         |                      |                             |                         |   |  |      |              |              |          |  |             |  |       |  |     |  |     |  |         |
| VIBRACOUSTIC  |                                |                                       |                         |                      |                             |                         |   |  |      |              |              |          |  |             |  |       |  |     |  |     |  |         |
| Code  | Manufacturer                   |                                       |                         |                      |                             |                         |   |  |      |              |              |          |  |             |  |       |  |     |  |     |  |         |
|   | FRUEHAUF                       |                                       |                         |                      |                             |                         |   |  |      |              |              |          |  |             |  |       |  |     |  |     |  |         |
|   | HENDRICKSON                    |                                       |                         |                      |                             |                         |   |  |      |              |              |          |  |             |  |       |  |     |  |     |  |         |
|   | NEWAY                          |                                       |                         |                      |                             |                         |   |  |      |              |              |          |  |             |  |       |  |     |  |     |  |         |
|   | ROR                            |                                       |                         |                      |                             |                         |   |  |      |              |              |          |  |             |  |       |  |     |  |     |  |         |
|   | SMB                            |                                       |                         |                      |                             |                         |   |  |      |              |              |          |  |             |  |       |  |     |  |     |  |         |
|   | WEWELER                        |                                       |                         |                      |                             |                         |   |  |      |              |              |          |  |             |  |       |  |     |  |     |  |         |



# Towing vehicle & Trailer & Semitrailer Air Springs

| Code   | Section, Top View, Bottom View | Applications                          |  |                      |                                |                          |   |      |              |              |          |              |             |          |         |          |          |          |         |
|--|--------------------------------|---------------------------------------|--|----------------------|--------------------------------|--------------------------|---|------|--------------|--------------|----------|--------------|-------------|----------|---------|----------|----------|----------|---------|
| <b>FM18043.C01P</b>  |                                |                                       |  |                      |                                |                          |   |      |              |              |          |              |             |          |         |          |          |          |         |
| <table border="1"> <tr> <td>Competitor code</td> </tr> <tr> <td>Firestone<br/>1T15 M-6<br/>W01-358-9361</td> </tr> <tr> <td>ContiTech<br/>4156 N P15; 4156<br/>N P06</td> </tr> <tr> <td>GOODYEAR<br/>1R12-716</td> </tr> <tr> <td>VIBRACOUSTIC</td> </tr> </table>    | Competitor code                | Firestone<br>1T15 M-6<br>W01-358-9361 | ContiTech<br>4156 N P15; 4156<br>N P06 | GOODYEAR<br>1R12-716 | VIBRACOUSTIC                   | <p>Piston: Composite</p> | <table border="1"> <thead> <tr> <th>Code</th> <th>Manufacturer</th> </tr> </thead> <tbody> <tr> <td>UJB 0207-001</td> <td>FRUEHAUF</td> </tr> <tr> <td>HA100001</td> <td>HENDRICKSON</td> </tr> <tr> <td>21215761</td> <td>ROR</td> </tr> <tr> <td>UJB 0207</td> <td>SMB</td> </tr> <tr> <td>US 35864</td> <td>WEWELER</td> </tr> </tbody> </table>                               | Code | Manufacturer | UJB 0207-001 | FRUEHAUF | HA100001     | HENDRICKSON | 21215761 | ROR     | UJB 0207 | SMB      | US 35864 | WEWELER |
| Competitor code  |                                |                                       |  |                      |                                |                          |   |      |              |              |          |              |             |          |         |          |          |          |         |
| Firestone<br>1T15 M-6<br>W01-358-9361  |                                |                                       |  |                      |                                |                          |   |      |              |              |          |              |             |          |         |          |          |          |         |
| ContiTech<br>4156 N P15; 4156<br>N P06   |                                |                                       |  |                      |                                |                          |   |      |              |              |          |              |             |          |         |          |          |          |         |
| GOODYEAR<br>1R12-716   |                                |                                       |  |                      |                                |                          |   |      |              |              |          |              |             |          |         |          |          |          |         |
| VIBRACOUSTIC   |                                |                                       |  |                      |                                |                          |   |      |              |              |          |              |             |          |         |          |          |          |         |
| Code   | Manufacturer                   |                                       |  |                      |                                |                          |   |      |              |              |          |              |             |          |         |          |          |          |         |
| UJB 0207-001   | FRUEHAUF                       |                                       |  |                      |                                |                          |   |      |              |              |          |              |             |          |         |          |          |          |         |
| HA100001   | HENDRICKSON                    |                                       |  |                      |                                |                          |   |      |              |              |          |              |             |          |         |          |          |          |         |
| 21215761   | ROR                            |                                       |  |                      |                                |                          |   |      |              |              |          |              |             |          |         |          |          |          |         |
| UJB 0207   | SMB                            |                                       |  |                      |                                |                          |   |      |              |              |          |              |             |          |         |          |          |          |         |
| US 35864   | WEWELER                        |                                       |  |                      |                                |                          |   |      |              |              |          |              |             |          |         |          |          |          |         |
| <b>FM18043.C02</b>   |                                |                                       |  |                      |                                |                          |   |      |              |              |          |              |             |          |         |          |          |          |         |
| <table border="1"> <tr> <td>Competitor code</td> </tr> <tr> <td>Firestone<br/>1T15 M-6<br/>W01-358-9361</td> </tr> <tr> <td>ContiTech<br/>4156 N P07</td> </tr> <tr> <td>GOODYEAR<br/>1R12-719</td> </tr> <tr> <td>VIBRACOUSTIC<br/>V 1 DK 23 K-28</td> </tr> </table> | Competitor code                | Firestone<br>1T15 M-6<br>W01-358-9361 | ContiTech<br>4156 N P07                | GOODYEAR<br>1R12-719 | VIBRACOUSTIC<br>V 1 DK 23 K-28 | <p>Piston: Steel</p>     | <table border="1"> <thead> <tr> <th>Code</th> <th>Manufacturer</th> </tr> </thead> <tbody> <tr> <td>M001472</td> <td>FRUEHAUF</td> </tr> <tr> <td></td> <td>SMB</td> </tr> </tbody> </table>  | Code | Manufacturer | M001472      | FRUEHAUF |              | SMB         |          |         |          |          |          |         |
| Competitor code  |                                |                                       |  |                      |                                |                          |   |      |              |              |          |              |             |          |         |          |          |          |         |
| Firestone<br>1T15 M-6<br>W01-358-9361  |                                |                                       |  |                      |                                |                          |   |      |              |              |          |              |             |          |         |          |          |          |         |
| ContiTech<br>4156 N P07  |                                |                                       |  |                      |                                |                          |   |      |              |              |          |              |             |          |         |          |          |          |         |
| GOODYEAR<br>1R12-719   |                                |                                       |  |                      |                                |                          |   |      |              |              |          |              |             |          |         |          |          |          |         |
| VIBRACOUSTIC<br>V 1 DK 23 K-28   |                                |                                       |  |                      |                                |                          |   |      |              |              |          |              |             |          |         |          |          |          |         |
| Code   | Manufacturer                   |                                       |  |                      |                                |                          |   |      |              |              |          |              |             |          |         |          |          |          |         |
| M001472  | FRUEHAUF                       |                                       |  |                      |                                |                          |   |      |              |              |          |              |             |          |         |          |          |          |         |
|  | SMB                            |                                       |  |                      |                                |                          |   |      |              |              |          |              |             |          |         |          |          |          |         |
| <b>FM18043.C03</b>   |                                |                                       |  |                      |                                |                          |   |      |              |              |          |              |             |          |         |          |          |          |         |
| <table border="1"> <tr> <td>Competitor code</td> </tr> <tr> <td>Firestone<br/>1T15 M-6<br/>W01-M58-9089</td> </tr> <tr> <td>ContiTech<br/>4156 N P09</td> </tr> <tr> <td>GOODYEAR<br/>1R12-706</td> </tr> <tr> <td>VIBRACOUSTIC<br/>V 1 DK 23 K-54</td> </tr> </table> | Competitor code                | Firestone<br>1T15 M-6<br>W01-M58-9089 | ContiTech<br>4156 N P09                | GOODYEAR<br>1R12-706 | VIBRACOUSTIC<br>V 1 DK 23 K-54 | <p>Piston: Steel</p>     | <table border="1"> <thead> <tr> <th>Code</th> <th>Manufacturer</th> </tr> </thead> <tbody> <tr> <td>M001472</td> <td rowspan="2">FRUEHAUF</td> </tr> <tr> <td>UJB 0207-001</td> </tr> <tr> <td>21216135</td> <td>SMB</td> </tr> <tr> <td>M001472</td> <td rowspan="3">FOR</td> </tr> <tr> <td>UJB 0207</td> </tr> <tr> <td>45402004</td> <td>Bertoja</td> </tr> </tbody> </table> | Code | Manufacturer | M001472      | FRUEHAUF | UJB 0207-001 | 21216135    | SMB      | M001472 | FOR      | UJB 0207 | 45402004 | Bertoja |
| Competitor code  |                                |                                       |  |                      |                                |                          |   |      |              |              |          |              |             |          |         |          |          |          |         |
| Firestone<br>1T15 M-6<br>W01-M58-9089  |                                |                                       |  |                      |                                |                          |   |      |              |              |          |              |             |          |         |          |          |          |         |
| ContiTech<br>4156 N P09  |                                |                                       |  |                      |                                |                          |   |      |              |              |          |              |             |          |         |          |          |          |         |
| GOODYEAR<br>1R12-706   |                                |                                       |  |                      |                                |                          |   |      |              |              |          |              |             |          |         |          |          |          |         |
| VIBRACOUSTIC<br>V 1 DK 23 K-54   |                                |                                       |  |                      |                                |                          |   |      |              |              |          |              |             |          |         |          |          |          |         |
| Code   | Manufacturer                   |                                       |  |                      |                                |                          |   |      |              |              |          |              |             |          |         |          |          |          |         |
| M001472  | FRUEHAUF                       |                                       |  |                      |                                |                          |   |      |              |              |          |              |             |          |         |          |          |          |         |
| UJB 0207-001   |                                |                                       |  |                      |                                |                          |   |      |              |              |          |              |             |          |         |          |          |          |         |
| 21216135   | SMB                            |                                       |  |                      |                                |                          |   |      |              |              |          |              |             |          |         |          |          |          |         |
| M001472  | FOR                            |                                       |  |                      |                                |                          |   |      |              |              |          |              |             |          |         |          |          |          |         |
| UJB 0207   |                                |                                       |  |                      |                                |                          |   |      |              |              |          |              |             |          |         |          |          |          |         |
| 45402004   |                                | Bertoja                               |  |                      |                                |                          |   |      |              |              |          |              |             |          |         |          |          |          |         |



# Towing vehicle & Trailer & Semitrailer Air Springs

| Code   | Section, Top View, Bottom View | Applications                                |  |                      |                                       |                          |  |      |              |                 |             |      |          |      |      |            |       |            |           |         |           |         |
|--|--------------------------------|---|--|----------------------|---------------------------------------|--------------------------|--|------|--------------|-----------------|-------------|------|----------|------|------|------------|-------|------------|-----------|---------|-----------|---------|
| <b>FM18043.C04P</b>  |                                |   |  |                      |                                       |                          |  |      |              |                 |             |      |          |      |      |            |       |            |           |         |           |         |
| <table border="1"> <tr> <td>Competitor code</td> </tr> <tr> <td>Firestone<br/>1T15 M-6<br/>W01-358-8929</td> </tr> <tr> <td>ContiTech<br/>4156 N P10</td> </tr> <tr> <td>GOODYEAR<br/>1R12-461</td> </tr> <tr> <td>VIBRACOUSTIC<br/>V 1 DK 23 K-54</td> </tr> </table>                   | Competitor code                | Firestone<br>1T15 M-6<br>W01-358-8929       | ContiTech<br>4156 N P10                | GOODYEAR<br>1R12-461 | VIBRACOUSTIC<br>V 1 DK 23 K-54        | <p>Piston: Composite</p> | <table border="1"> <tr> <th>Code</th> <th>Manufacturer</th> </tr> <tr> <td>HA 100016</td> <td>HENDRICKSON</td> </tr> </table>  | Code | Manufacturer | HA 100016       | HENDRICKSON |      |          |      |      |            |       |            |           |         |           |         |
| Competitor code  |                                |   |  |                      |                                       |                          |  |      |              |                 |             |      |          |      |      |            |       |            |           |         |           |         |
| Firestone<br>1T15 M-6<br>W01-358-8929  |                                |   |  |                      |                                       |                          |  |      |              |                 |             |      |          |      |      |            |       |            |           |         |           |         |
| ContiTech<br>4156 N P10  |                                |   |  |                      |                                       |                          |  |      |              |                 |             |      |          |      |      |            |       |            |           |         |           |         |
| GOODYEAR<br>1R12-461   |                                |   |  |                      |                                       |                          |  |      |              |                 |             |      |          |      |      |            |       |            |           |         |           |         |
| VIBRACOUSTIC<br>V 1 DK 23 K-54   |                                |   |  |                      |                                       |                          |  |      |              |                 |             |      |          |      |      |            |       |            |           |         |           |         |
| Code   | Manufacturer                   |   |  |                      |                                       |                          |  |      |              |                 |             |      |          |      |      |            |       |            |           |         |           |         |
| HA 100016  | HENDRICKSON                    |   |  |                      |                                       |                          |  |      |              |                 |             |      |          |      |      |            |       |            |           |         |           |         |
| <b>FM18043.C05P</b>  |                                |   |  |                      |                                       |                          |  |      |              |                 |             |      |          |      |      |            |       |            |           |         |           |         |
| <table border="1"> <tr> <td>Competitor code</td> </tr> <tr> <td>Firestone<br/>1T15 M-6<br/>W01-358-9082</td> </tr> <tr> <td>ContiTech<br/>4156 N P04;<br/>4156 N P14</td> </tr> <tr> <td>GOODYEAR<br/>1R12-092</td> </tr> <tr> <td>VIBRACOUSTIC<br/>V 1 DK 23 K-9082</td> </tr> </table> | Competitor code                | Firestone<br>1T15 M-6<br>W01-358-9082       | ContiTech<br>4156 N P04;<br>4156 N P14 | GOODYEAR<br>1R12-092 | VIBRACOUSTIC<br>V 1 DK 23 K-9082      | <p>Piston: Composite</p> | <table border="1"> <tr> <th>Code</th> <th>Manufacturer</th> </tr> <tr> <td>B 2066</td> <td>HENDRICKSON</td> </tr> <tr> <td>2727</td> <td rowspan="3">Granning</td> </tr> <tr> <td>1359</td> </tr> <tr> <td>1528</td> </tr> <tr> <td>905 570 27</td> <td rowspan="2">Neway</td> </tr> <tr> <td>905 570 33</td> </tr> <tr> <td>US 09361F</td> <td>Weweler</td> </tr> <tr> <td>2120 8939</td> <td>Meritor</td> </tr> </table> | Code | Manufacturer | B 2066          | HENDRICKSON | 2727 | Granning | 1359 | 1528 | 905 570 27 | Neway | 905 570 33 | US 09361F | Weweler | 2120 8939 | Meritor |
| Competitor code  |                                |   |  |                      |                                       |                          |  |      |              |                 |             |      |          |      |      |            |       |            |           |         |           |         |
| Firestone<br>1T15 M-6<br>W01-358-9082  |                                |   |  |                      |                                       |                          |  |      |              |                 |             |      |          |      |      |            |       |            |           |         |           |         |
| ContiTech<br>4156 N P04;<br>4156 N P14   |                                |   |  |                      |                                       |                          |  |      |              |                 |             |      |          |      |      |            |       |            |           |         |           |         |
| GOODYEAR<br>1R12-092   |                                |   |  |                      |                                       |                          |  |      |              |                 |             |      |          |      |      |            |       |            |           |         |           |         |
| VIBRACOUSTIC<br>V 1 DK 23 K-9082   |                                |   |  |                      |                                       |                          |  |      |              |                 |             |      |          |      |      |            |       |            |           |         |           |         |
| Code   | Manufacturer                   |   |  |                      |                                       |                          |  |      |              |                 |             |      |          |      |      |            |       |            |           |         |           |         |
| B 2066   | HENDRICKSON                    |   |  |                      |                                       |                          |  |      |              |                 |             |      |          |      |      |            |       |            |           |         |           |         |
| 2727   | Granning                       |   |  |                      |                                       |                          |  |      |              |                 |             |      |          |      |      |            |       |            |           |         |           |         |
| 1359   |                                |   |  |                      |                                       |                          |  |      |              |                 |             |      |          |      |      |            |       |            |           |         |           |         |
| 1528   |                                |   |  |                      |                                       |                          |  |      |              |                 |             |      |          |      |      |            |       |            |           |         |           |         |
| 905 570 27   | Neway                          |   |  |                      |                                       |                          |  |      |              |                 |             |      |          |      |      |            |       |            |           |         |           |         |
| 905 570 33   |                                |   |  |                      |                                       |                          |  |      |              |                 |             |      |          |      |      |            |       |            |           |         |           |         |
| US 09361F  | Weweler                        |   |  |                      |                                       |                          |  |      |              |                 |             |      |          |      |      |            |       |            |           |         |           |         |
| 2120 8939  | Meritor                        |   |  |                      |                                       |                          |  |      |              |                 |             |      |          |      |      |            |       |            |           |         |           |         |
| <b>FM18044.H01</b>   |                                |   |  |                      |                                       |                          |  |      |              |                 |             |      |          |      |      |            |       |            |           |         |           |         |
| <table border="1"> <tr> <td>Competitor code</td> </tr> <tr> <td>Firestone<br/>1R7Z-460-305-A<br/>W01-M58-0909</td> </tr> <tr> <td>ContiTech<br/>4757 N1</td> </tr> <tr> <td>GOODYEAR<br/>9517</td> </tr> <tr> <td>VIBRACOUSTIC<br/>V 1 KF 24-1-232<br/>NP</td> </tr> </table>            | Competitor code                | Firestone<br>1R7Z-460-305-A<br>W01-M58-0909 | ContiTech<br>4757 N1                   | GOODYEAR<br>9517     | VIBRACOUSTIC<br>V 1 KF 24-1-232<br>NP | <p>Piston: No</p>        | <table border="1"> <tr> <th>Code</th> <th>Manufacturer</th> </tr> <tr> <td>A 974 327 00 01</td> <td>MERCEDES</td> </tr> </table>   | Code | Manufacturer | A 974 327 00 01 | MERCEDES    |      |          |      |      |            |       |            |           |         |           |         |
| Competitor code  |                                |   |  |                      |                                       |                          |  |      |              |                 |             |      |          |      |      |            |       |            |           |         |           |         |
| Firestone<br>1R7Z-460-305-A<br>W01-M58-0909  |                                |   |  |                      |                                       |                          |  |      |              |                 |             |      |          |      |      |            |       |            |           |         |           |         |
| ContiTech<br>4757 N1   |                                |   |  |                      |                                       |                          |  |      |              |                 |             |      |          |      |      |            |       |            |           |         |           |         |
| GOODYEAR<br>9517   |                                |   |  |                      |                                       |                          |  |      |              |                 |             |      |          |      |      |            |       |            |           |         |           |         |
| VIBRACOUSTIC<br>V 1 KF 24-1-232<br>NP  |                                |   |  |                      |                                       |                          |  |      |              |                 |             |      |          |      |      |            |       |            |           |         |           |         |
| Code   | Manufacturer                   |   |  |                      |                                       |                          |  |      |              |                 |             |      |          |      |      |            |       |            |           |         |           |         |
| A 974 327 00 01  | MERCEDES                       |   |  |                      |                                       |                          |  |      |              |                 |             |      |          |      |      |            |       |            |           |         |           |         |



# Towing vehicle & Trailer & Semitrailer Air Springs

| Code  | Section, Top View, Bottom View | Applications                                |  |                  |                                       |                      |  |  |      |              |                 |          |                 |
|---|--------------------------------|---|--|------------------|---------------------------------------|----------------------|--|--|------|--------------|-----------------|----------|-----------------|
| <b>FM18044.H02</b>  |                                |   |  |                  |                                       |                      |  |  |      |              |                 |          |                 |
| <table border="1"> <tr> <td>Competitor code</td> </tr> <tr> <td>Firestone<br/>1R7Z-460-305-B<br/>W01-M58-0910</td> </tr> <tr> <td>ContiTech<br/>4757 N2</td> </tr> <tr> <td>GOODYEAR<br/>9518</td> </tr> <tr> <td>VIBRACOUSTIC<br/>V 1 KF 24-2-232<br/>NP</td> </tr> </table>             | Competitor code                | Firestone<br>1R7Z-460-305-B<br>W01-M58-0910 | ContiTech<br>4757 N2                   | GOODYEAR<br>9518 | VIBRACOUSTIC<br>V 1 KF 24-2-232<br>NP | <p>Piston: No</p>    | <table border="1"> <tr> <th>Code</th> <th>Manufacturer</th> </tr> <tr> <td>A 974 328 00 01</td> <td>MERCEDES</td> </tr> </table>   |  | Code | Manufacturer | A 974 328 00 01 | MERCEDES |                 |
| Competitor code   |                                |   |  |                  |                                       |                      |  |  |      |              |                 |          |                 |
| Firestone<br>1R7Z-460-305-B<br>W01-M58-0910   |                                |   |  |                  |                                       |                      |  |  |      |              |                 |          |                 |
| ContiTech<br>4757 N2  |                                |   |  |                  |                                       |                      |  |  |      |              |                 |          |                 |
| GOODYEAR<br>9518  |                                |   |  |                  |                                       |                      |  |  |      |              |                 |          |                 |
| VIBRACOUSTIC<br>V 1 KF 24-2-232<br>NP   |                                |   |  |                  |                                       |                      |  |  |      |              |                 |          |                 |
| Code  | Manufacturer                   |   |  |                  |                                       |                      |  |  |      |              |                 |          |                 |
| A 974 328 00 01   | MERCEDES                       |   |  |                  |                                       |                      |  |  |      |              |                 |          |                 |
| <b>FM18044.C01</b>  |                                |   |  |                  |                                       |                      |  |  |      |              |                 |          |                 |
| <table border="1"> <tr> <td>Competitor code</td> </tr> <tr> <td>Firestone<br/>1R7Z-460-305-A<br/>W01-M58-8521</td> </tr> <tr> <td>ContiTech<br/>4757 N P01;<br/>4757 N P21</td> </tr> <tr> <td>GOODYEAR<br/>9519</td> </tr> <tr> <td>VIBRACOUSTIC<br/>V 1 KF 24-1-232</td> </tr> </table> | Competitor code                | Firestone<br>1R7Z-460-305-A<br>W01-M58-8521 | ContiTech<br>4757 N P01;<br>4757 N P21 | GOODYEAR<br>9519 | VIBRACOUSTIC<br>V 1 KF 24-1-232       | <p>Piston: Steel</p> | <table border="1"> <tr> <th>Code</th> <th>Manufacturer</th> </tr> <tr> <td>A 942 320 01 17</td> <td rowspan="2">MERCEDES</td> </tr> <tr> <td>A 942 320 43 21</td> </tr> </table> |  | Code | Manufacturer | A 942 320 01 17 | MERCEDES | A 942 320 43 21 |
| Competitor code   |                                |   |  |                  |                                       |                      |  |  |      |              |                 |          |                 |
| Firestone<br>1R7Z-460-305-A<br>W01-M58-8521   |                                |   |  |                  |                                       |                      |  |  |      |              |                 |          |                 |
| ContiTech<br>4757 N P01;<br>4757 N P21  |                                |   |  |                  |                                       |                      |  |  |      |              |                 |          |                 |
| GOODYEAR<br>9519  |                                |   |  |                  |                                       |                      |  |  |      |              |                 |          |                 |
| VIBRACOUSTIC<br>V 1 KF 24-1-232   |                                |   |  |                  |                                       |                      |  |  |      |              |                 |          |                 |
| Code  | Manufacturer                   |   |  |                  |                                       |                      |  |  |      |              |                 |          |                 |
| A 942 320 01 17   | MERCEDES                       |   |  |                  |                                       |                      |  |  |      |              |                 |          |                 |
| A 942 320 43 21   |                                |   |  |                  |                                       |                      |  |  |      |              |                 |          |                 |
| <b>FM18044.C02</b>  |                                |   |  |                  |                                       |                      |  |  |      |              |                 |          |                 |
| <table border="1"> <tr> <td>Competitor code</td> </tr> <tr> <td>Firestone<br/>1R7Z-460-305-B<br/>W01-M58-8522</td> </tr> <tr> <td>ContiTech<br/>4757 N P29;<br/>4757 N P09</td> </tr> <tr> <td>GOODYEAR<br/>9520</td> </tr> <tr> <td>VIBRACOUSTIC<br/>V 1 KF 24-2-232</td> </tr> </table> | Competitor code                | Firestone<br>1R7Z-460-305-B<br>W01-M58-8522 | ContiTech<br>4757 N P29;<br>4757 N P09 | GOODYEAR<br>9520 | VIBRACOUSTIC<br>V 1 KF 24-2-232       | <p>Piston: Steel</p> | <table border="1"> <tr> <th>Code</th> <th>Manufacturer</th> </tr> <tr> <td>A 974 320 04 17</td> <td rowspan="2">MERCEDES</td> </tr> <tr> <td>A 942 320 32 21</td> </tr> </table> |  | Code | Manufacturer | A 974 320 04 17 | MERCEDES | A 942 320 32 21 |
| Competitor code   |                                |   |  |                  |                                       |                      |  |  |      |              |                 |          |                 |
| Firestone<br>1R7Z-460-305-B<br>W01-M58-8522   |                                |   |  |                  |                                       |                      |  |  |      |              |                 |          |                 |
| ContiTech<br>4757 N P29;<br>4757 N P09  |                                |   |  |                  |                                       |                      |  |  |      |              |                 |          |                 |
| GOODYEAR<br>9520  |                                |   |  |                  |                                       |                      |  |  |      |              |                 |          |                 |
| VIBRACOUSTIC<br>V 1 KF 24-2-232   |                                |   |  |                  |                                       |                      |  |  |      |              |                 |          |                 |
| Code  | Manufacturer                   |   |  |                  |                                       |                      |  |  |      |              |                 |          |                 |
| A 974 320 04 17   | MERCEDES                       |   |  |                  |                                       |                      |  |  |      |              |                 |          |                 |
| A 942 320 32 21   |                                |   |  |                  |                                       |                      |  |  |      |              |                 |          |                 |



# Towing vehicle & Trailer & Semitrailer Air Springs

| Code  | Section, Top View, Bottom View | Applications                                |  |                  |                                |                      |  |  |      |              |                 |          |                 |                 |
|---|--------------------------------|---|--|------------------|--------------------------------|----------------------|--|--|------|--------------|-----------------|----------|-----------------|-----------------|
| <b>FM18045.H01</b>  |                                |   |  |                  |                                |                      |  |  |      |              |                 |          |                 |                 |
| <table border="1"> <tr><td>Competitor code</td></tr> <tr><td>Firestone<br/>1R7Z-440-290-B<br/>W01-M58-0904</td></tr> <tr><td>ContiTech<br/>4390 N1</td></tr> <tr><td>GOODYEAR<br/>9507</td></tr> <tr><td>VIBRACOUSTIC<br/>V 1 KF 21-1 NP</td></tr> </table>                 | Competitor code                | Firestone<br>1R7Z-440-290-B<br>W01-M58-0904 | ContiTech<br>4390 N1                   | GOODYEAR<br>9507 | VIBRACOUSTIC<br>V 1 KF 21-1 NP | <p>Piston: No</p>    | <table border="1"> <tr> <th data-bbox="956 424 1182 452">Code</th> <th data-bbox="1187 424 1431 452">Manufacturer</th> </tr> <tr> <td data-bbox="956 459 1182 487">A 942 328 00 01</td> <td data-bbox="1187 459 1431 487">MERCEDES</td> </tr> </table>   |  | Code | Manufacturer | A 942 328 00 01 | MERCEDES |                 |                 |
| Competitor code   |                                |   |  |                  |                                |                      |  |  |      |              |                 |          |                 |                 |
| Firestone<br>1R7Z-440-290-B<br>W01-M58-0904   |                                |   |  |                  |                                |                      |  |  |      |              |                 |          |                 |                 |
| ContiTech<br>4390 N1  |                                |   |  |                  |                                |                      |  |  |      |              |                 |          |                 |                 |
| GOODYEAR<br>9507  |                                |   |  |                  |                                |                      |  |  |      |              |                 |          |                 |                 |
| VIBRACOUSTIC<br>V 1 KF 21-1 NP  |                                |   |  |                  |                                |                      |  |  |      |              |                 |          |                 |                 |
| Code  | Manufacturer                   |   |  |                  |                                |                      |  |  |      |              |                 |          |                 |                 |
| A 942 328 00 01   | MERCEDES                       |   |  |                  |                                |                      |  |  |      |              |                 |          |                 |                 |
| <b>FM18045.H02</b>  |                                |   |  |                  |                                |                      |  |  |      |              |                 |          |                 |                 |
| <table border="1"> <tr><td>Competitor code</td></tr> <tr><td>Firestone</td></tr> <tr><td>ContiTech<br/>4390 N2</td></tr> <tr><td>GOODYEAR</td></tr> <tr><td>VIBRACOUSTIC</td></tr> </table>   | Competitor code                | Firestone                                   | ContiTech<br>4390 N2                   | GOODYEAR         | VIBRACOUSTIC                   | <p>Piston: No</p>    | <table border="1"> <tr> <th data-bbox="956 1009 1182 1037">Code</th> <th data-bbox="1187 1009 1431 1037">Manufacturer</th> </tr> <tr> <td data-bbox="956 1043 1182 1071"></td> <td data-bbox="1187 1043 1431 1071"></td> </tr> </table>  |  | Code | Manufacturer |                 |          |                 |                 |
| Competitor code   |                                |   |  |                  |                                |                      |  |  |      |              |                 |          |                 |                 |
| Firestone   |                                |   |  |                  |                                |                      |  |  |      |              |                 |          |                 |                 |
| ContiTech<br>4390 N2  |                                |   |  |                  |                                |                      |  |  |      |              |                 |          |                 |                 |
| GOODYEAR  |                                |   |  |                  |                                |                      |  |  |      |              |                 |          |                 |                 |
| VIBRACOUSTIC  |                                |   |  |                  |                                |                      |  |  |      |              |                 |          |                 |                 |
| Code  | Manufacturer                   |   |  |                  |                                |                      |  |  |      |              |                 |          |                 |                 |
|   |                                |   |  |                  |                                |                      |  |  |      |              |                 |          |                 |                 |
| <b>FM18045.C01</b>  |                                |   |  |                  |                                |                      |  |  |      |              |                 |          |                 |                 |
| <table border="1"> <tr><td>Competitor code</td></tr> <tr><td>Firestone<br/>1R7Z-440-290-B<br/>W01-M58-8514</td></tr> <tr><td>ContiTech<br/>4390 N P01;<br/>4390 N P21</td></tr> <tr><td>GOODYEAR<br/>9505</td></tr> <tr><td>VIBRACOUSTIC<br/>V 1 KF 21-1</td></tr> </table> | Competitor code                | Firestone<br>1R7Z-440-290-B<br>W01-M58-8514 | ContiTech<br>4390 N P01;<br>4390 N P21 | GOODYEAR<br>9505 | VIBRACOUSTIC<br>V 1 KF 21-1    | <p>Piston: Steel</p> | <table border="1"> <tr> <th data-bbox="956 1558 1182 1586">Code</th> <th data-bbox="1187 1558 1431 1586">Manufacturer</th> </tr> <tr> <td data-bbox="956 1593 1182 1621">A 942 320 01 21</td> <td data-bbox="1187 1593 1431 1621" rowspan="3">MERCEDES</td> </tr> <tr> <td data-bbox="956 1627 1182 1655">A 942 320 49 21</td> </tr> <tr> <td data-bbox="956 1662 1182 1690">A 942 320 28 21</td> </tr> </table> |  | Code | Manufacturer | A 942 320 01 21 | MERCEDES | A 942 320 49 21 | A 942 320 28 21 |
| Competitor code   |                                |   |  |                  |                                |                      |  |  |      |              |                 |          |                 |                 |
| Firestone<br>1R7Z-440-290-B<br>W01-M58-8514   |                                |   |  |                  |                                |                      |  |  |      |              |                 |          |                 |                 |
| ContiTech<br>4390 N P01;<br>4390 N P21  |                                |   |  |                  |                                |                      |  |  |      |              |                 |          |                 |                 |
| GOODYEAR<br>9505  |                                |   |  |                  |                                |                      |  |  |      |              |                 |          |                 |                 |
| VIBRACOUSTIC<br>V 1 KF 21-1   |                                |   |  |                  |                                |                      |  |  |      |              |                 |          |                 |                 |
| Code  | Manufacturer                   |   |  |                  |                                |                      |  |  |      |              |                 |          |                 |                 |
| A 942 320 01 21   | MERCEDES                       |   |  |                  |                                |                      |  |  |      |              |                 |          |                 |                 |
| A 942 320 49 21   |                                |   |  |                  |                                |                      |  |  |      |              |                 |          |                 |                 |
| A 942 320 28 21   |                                |   |  |                  |                                |                      |  |  |      |              |                 |          |                 |                 |



# Towing vehicle & Trailer & Semitrailer Air Springs

| Code  | Section, Top View, Bottom View | Applications                                |  |                  |                             |                      |  |  |      |              |                 |          |                 |                 |
|---|--------------------------------|---|--|------------------|-----------------------------|----------------------|--|--|------|--------------|-----------------|----------|-----------------|-----------------|
| <b>FM18045.H01</b>  |                                |   |  |                  |                             |                      |  |  |      |              |                 |          |                 |                 |
| <table border="1"> <tr><td>Competitor code</td></tr> <tr><td>Firestone</td></tr> <tr><td>ContiTech<br/>4390 N P04; 4390<br/>N P24</td></tr> <tr><td>GOODYEAR<br/>9564</td></tr> <tr><td>VIBRACOUSTIC<br/>V 1 KF 21-3</td></tr> </table>                                     | Competitor code                | Firestone                                   | ContiTech<br>4390 N P04; 4390<br>N P24 | GOODYEAR<br>9564 | VIBRACOUSTIC<br>V 1 KF 21-3 | <p>Piston: Steel</p> | <table border="1"> <thead> <tr> <th>Code</th> <th>Manufacturer</th> </tr> </thead> <tbody> <tr> <td>A 942 320 03 21</td> <td rowspan="2">MERCEDES</td> </tr> <tr> <td>A 942 320 51 21</td> </tr> </tbody> </table>                                     |  | Code | Manufacturer | A 942 320 03 21 | MERCEDES | A 942 320 51 21 |                 |
| Competitor code   |                                |   |  |                  |                             |                      |  |  |      |              |                 |          |                 |                 |
| Firestone   |                                |   |  |                  |                             |                      |  |  |      |              |                 |          |                 |                 |
| ContiTech<br>4390 N P04; 4390<br>N P24  |                                |   |  |                  |                             |                      |  |  |      |              |                 |          |                 |                 |
| GOODYEAR<br>9564  |                                |   |  |                  |                             |                      |  |  |      |              |                 |          |                 |                 |
| VIBRACOUSTIC<br>V 1 KF 21-3   |                                |   |  |                  |                             |                      |  |  |      |              |                 |          |                 |                 |
| Code  | Manufacturer                   |   |  |                  |                             |                      |  |  |      |              |                 |          |                 |                 |
| A 942 320 03 21   | MERCEDES                       |   |  |                  |                             |                      |  |  |      |              |                 |          |                 |                 |
| A 942 320 51 21   |                                |   |  |                  |                             |                      |  |  |      |              |                 |          |                 |                 |
| <b>FM18045.H02</b>  |                                |   |  |                  |                             |                      |  |  |      |              |                 |          |                 |                 |
| <table border="1"> <tr><td>Competitor code</td></tr> <tr><td>Firestone<br/>1R7Z-440-290-C<br/>W01-M58-8513</td></tr> <tr><td>ContiTech<br/>4390 N P02;<br/>4390 N P22</td></tr> <tr><td>GOODYEAR<br/>9506</td></tr> <tr><td>VIBRACOUSTIC<br/>V 1 KF 21-2</td></tr> </table> | Competitor code                | Firestone<br>1R7Z-440-290-C<br>W01-M58-8513 | ContiTech<br>4390 N P02;<br>4390 N P22 | GOODYEAR<br>9506 | VIBRACOUSTIC<br>V 1 KF 21-2 | <p>Piston: Steel</p> | <table border="1"> <thead> <tr> <th>Code</th> <th>Manufacturer</th> </tr> </thead> <tbody> <tr> <td>A 942 320 02 21</td> <td rowspan="3">MERCEDES</td> </tr> <tr> <td>A 942 320 29 21</td> </tr> <tr> <td>A 942 320 50 21</td> </tr> </tbody> </table> |  | Code | Manufacturer | A 942 320 02 21 | MERCEDES | A 942 320 29 21 | A 942 320 50 21 |
| Competitor code   |                                |   |  |                  |                             |                      |  |  |      |              |                 |          |                 |                 |
| Firestone<br>1R7Z-440-290-C<br>W01-M58-8513   |                                |   |  |                  |                             |                      |  |  |      |              |                 |          |                 |                 |
| ContiTech<br>4390 N P02;<br>4390 N P22  |                                |   |  |                  |                             |                      |  |  |      |              |                 |          |                 |                 |
| GOODYEAR<br>9506  |                                |   |  |                  |                             |                      |  |  |      |              |                 |          |                 |                 |
| VIBRACOUSTIC<br>V 1 KF 21-2   |                                |   |  |                  |                             |                      |  |  |      |              |                 |          |                 |                 |
| Code  | Manufacturer                   |   |  |                  |                             |                      |  |  |      |              |                 |          |                 |                 |
| A 942 320 02 21   | MERCEDES                       |   |  |                  |                             |                      |  |  |      |              |                 |          |                 |                 |
| A 942 320 29 21   |                                |   |  |                  |                             |                      |  |  |      |              |                 |          |                 |                 |
| A 942 320 50 21   |                                |   |  |                  |                             |                      |  |  |      |              |                 |          |                 |                 |
| <b>FM18045.C01</b>  |                                |   |  |                  |                             |                      |  |  |      |              |                 |          |                 |                 |
| <table border="1"> <tr><td>Competitor code</td></tr> <tr><td>Firestone</td></tr> <tr><td>ContiTech<br/>4390 N P03;<br/>4390 N P23</td></tr> <tr><td>GOODYEAR<br/>9563</td></tr> <tr><td>VIBRACOUSTIC<br/>C V1KF21-4</td></tr> </table>                                      | Competitor code                | Firestone                                   | ContiTech<br>4390 N P03;<br>4390 N P23 | GOODYEAR<br>9563 | VIBRACOUSTIC<br>C V1KF21-4  | <p>Piston: Steel</p> | <table border="1"> <thead> <tr> <th>Code</th> <th>Manufacturer</th> </tr> </thead> <tbody> <tr> <td>A 942 320 04 21</td> <td rowspan="2">MERCEDES</td> </tr> <tr> <td>A 942 320 52 21</td> </tr> </tbody> </table>                                     |  | Code | Manufacturer | A 942 320 04 21 | MERCEDES | A 942 320 52 21 |                 |
| Competitor code   |                                |   |  |                  |                             |                      |  |  |      |              |                 |          |                 |                 |
| Firestone   |                                |   |  |                  |                             |                      |  |  |      |              |                 |          |                 |                 |
| ContiTech<br>4390 N P03;<br>4390 N P23  |                                |   |  |                  |                             |                      |  |  |      |              |                 |          |                 |                 |
| GOODYEAR<br>9563  |                                |   |  |                  |                             |                      |  |  |      |              |                 |          |                 |                 |
| VIBRACOUSTIC<br>C V1KF21-4  |                                |   |  |                  |                             |                      |  |  |      |              |                 |          |                 |                 |
| Code  | Manufacturer                   |   |  |                  |                             |                      |  |  |      |              |                 |          |                 |                 |
| A 942 320 04 21   | MERCEDES                       |   |  |                  |                             |                      |  |  |      |              |                 |          |                 |                 |
| A 942 320 52 21   |                                |   |  |                  |                             |                      |  |  |      |              |                 |          |                 |                 |



# Towing vehicle & Trailer & Semitrailer Air Springs

| Code   | Section, Top View, Bottom View | Applications                                |   |                        |                                       |                      |  |  |      |              |                 |          |                 |                 |                 |
|--|--------------------------------|---|---|------------------------|---------------------------------------|----------------------|--|--|------|--------------|-----------------|----------|-----------------|-----------------|-----------------|
| <b>FM18046.H01</b>   |                                |   |   |                        |                                       |                      |  |  |      |              |                 |          |                 |                 |                 |
| <table border="1"> <tr><td>Competitor code</td></tr> <tr><td>Firestone<br/>1R7Z-595-330-A<br/>W01-M58-0912</td></tr> <tr><td>ContiTech<br/>4838 N</td></tr> <tr><td>GOODYEAR<br/>9560</td></tr> <tr><td>VIBRACOUSTIC<br/>V 1 KF 25-1-232<br/>NP</td></tr> </table>               | Competitor code                | Firestone<br>1R7Z-595-330-A<br>W01-M58-0912 | ContiTech<br>4838 N   | GOODYEAR<br>9560       | VIBRACOUSTIC<br>V 1 KF 25-1-232<br>NP | <p>Piston: No</p>    | <table border="1"> <tr> <th>Code</th> <th>Manufacturer</th> </tr> <tr> <td>A 946 328 00 01</td> <td>MERCEDES</td> </tr> </table>   |  | Code | Manufacturer | A 946 328 00 01 | MERCEDES |                 |                 |                 |
| Competitor code  |                                |   |   |                        |                                       |                      |  |  |      |              |                 |          |                 |                 |                 |
| Firestone<br>1R7Z-595-330-A<br>W01-M58-0912  |                                |   |   |                        |                                       |                      |  |  |      |              |                 |          |                 |                 |                 |
| ContiTech<br>4838 N  |                                |   |   |                        |                                       |                      |  |  |      |              |                 |          |                 |                 |                 |
| GOODYEAR<br>9560   |                                |   |   |                        |                                       |                      |  |  |      |              |                 |          |                 |                 |                 |
| VIBRACOUSTIC<br>V 1 KF 25-1-232<br>NP  |                                |   |   |                        |                                       |                      |  |  |      |              |                 |          |                 |                 |                 |
| Code   | Manufacturer                   |   |   |                        |                                       |                      |  |  |      |              |                 |          |                 |                 |                 |
| A 946 328 00 01  | MERCEDES                       |   |   |                        |                                       |                      |  |  |      |              |                 |          |                 |                 |                 |
| <b>FM18046.C01</b>   |                                |   |   |                        |                                       |                      |  |  |      |              |                 |          |                 |                 |                 |
| <table border="1"> <tr><td>Competitor code</td></tr> <tr><td>Firestone<br/>1R7Z-595-330-A<br/>W01-M58-8512</td></tr> <tr><td>ContiTech<br/>4838 N P01;<br/>4838 N P21</td></tr> <tr><td>GOODYEAR<br/>9521</td></tr> <tr><td>VIBRACOUSTIC<br/>V 1 KF 25-1-232</td></tr> </table>  | Competitor code                | Firestone<br>1R7Z-595-330-A<br>W01-M58-8512 | ContiTech<br>4838 N P01;<br>4838 N P21                              | GOODYEAR<br>9521       | VIBRACOUSTIC<br>V 1 KF 25-1-232       | <p>Piston: No</p>    | <table border="1"> <tr> <th>Code</th> <th>Manufacturer</th> </tr> <tr> <td>A 942 320 38 21</td> <td rowspan="2">MERCEDES</td> </tr> <tr> <td>A 946 320 04 21</td> </tr> </table>   |  | Code | Manufacturer | A 942 320 38 21 | MERCEDES | A 946 320 04 21 |                 |                 |
| Competitor code  |                                |   |   |                        |                                       |                      |  |  |      |              |                 |          |                 |                 |                 |
| Firestone<br>1R7Z-595-330-A<br>W01-M58-8512  |                                |   |   |                        |                                       |                      |  |  |      |              |                 |          |                 |                 |                 |
| ContiTech<br>4838 N P01;<br>4838 N P21   |                                |   |   |                        |                                       |                      |  |  |      |              |                 |          |                 |                 |                 |
| GOODYEAR<br>9521   |                                |   |   |                        |                                       |                      |  |  |      |              |                 |          |                 |                 |                 |
| VIBRACOUSTIC<br>V 1 KF 25-1-232  |                                |   |   |                        |                                       |                      |  |  |      |              |                 |          |                 |                 |                 |
| Code   | Manufacturer                   |   |   |                        |                                       |                      |  |  |      |              |                 |          |                 |                 |                 |
| A 942 320 38 21  | MERCEDES                       |   |   |                        |                                       |                      |  |  |      |              |                 |          |                 |                 |                 |
| A 946 320 04 21  |                                |   |   |                        |                                       |                      |  |  |      |              |                 |          |                 |                 |                 |
| <b>FM18046.C02</b>   |                                |   |   |                        |                                       |                      |  |  |      |              |                 |          |                 |                 |                 |
| <table border="1"> <tr><td>Competitor code</td></tr> <tr><td>Firestone</td></tr> <tr><td>ContiTech<br/>4838 N P02;<br/>4838 N P22<br/>4838 N P03;<br/>4838 N P23</td></tr> <tr><td>GOODYEAR<br/>9522; 9536</td></tr> <tr><td>VIBRACOUSTIC<br/>V 1 KF 25-2-232</td></tr> </table> | Competitor code                | Firestone                                   | ContiTech<br>4838 N P02;<br>4838 N P22<br>4838 N P03;<br>4838 N P23 | GOODYEAR<br>9522; 9536 | VIBRACOUSTIC<br>V 1 KF 25-2-232       | <p>Piston: Steel</p> | <table border="1"> <tr> <th>Code</th> <th>Manufacturer</th> </tr> <tr> <td>A 942 320 36 21</td> <td rowspan="4">MERCEDES</td> </tr> <tr> <td>A 946 320 02 21</td> </tr> <tr> <td>A 942 320 01 21</td> </tr> <tr> <td>A 946 320 35 21</td> </tr> </table> |  | Code | Manufacturer | A 942 320 36 21 | MERCEDES | A 946 320 02 21 | A 942 320 01 21 | A 946 320 35 21 |
| Competitor code  |                                |   |   |                        |                                       |                      |  |  |      |              |                 |          |                 |                 |                 |
| Firestone  |                                |   |   |                        |                                       |                      |  |  |      |              |                 |          |                 |                 |                 |
| ContiTech<br>4838 N P02;<br>4838 N P22<br>4838 N P03;<br>4838 N P23  |                                |   |   |                        |                                       |                      |  |  |      |              |                 |          |                 |                 |                 |
| GOODYEAR<br>9522; 9536   |                                |   |   |                        |                                       |                      |  |  |      |              |                 |          |                 |                 |                 |
| VIBRACOUSTIC<br>V 1 KF 25-2-232  |                                |   |   |                        |                                       |                      |  |  |      |              |                 |          |                 |                 |                 |
| Code   | Manufacturer                   |   |   |                        |                                       |                      |  |  |      |              |                 |          |                 |                 |                 |
| A 942 320 36 21  | MERCEDES                       |   |   |                        |                                       |                      |  |  |      |              |                 |          |                 |                 |                 |
| A 946 320 02 21  |                                |   |   |                        |                                       |                      |  |  |      |              |                 |          |                 |                 |                 |
| A 942 320 01 21  |                                |   |   |                        |                                       |                      |  |  |      |              |                 |          |                 |                 |                 |
| A 946 320 35 21  |                                |   |   |                        |                                       |                      |  |  |      |              |                 |          |                 |                 |                 |



# Towing vehicle & Trailer & Semitrailer Air Springs

| Code  | Section, Top View, Bottom View | Applications                          |                         |                      |                                  |                          |   |  |      |              |              |          |              |          |          |       |          |       |          |     |
|---|--------------------------------|---------------------------------------|-------------------------|----------------------|----------------------------------|--------------------------|---|--|------|--------------|--------------|----------|--------------|----------|----------|-------|----------|-------|----------|-----|
| <b>FM18047.H01</b>  |                                |                                       |                         |                      |                                  |                          |   |  |      |              |              |          |              |          |          |       |          |       |          |     |
| <table border="1"> <tr> <td>Competitor code</td> </tr> <tr> <td>Firestone<br/>1T15 M-9<br/>W01-M58-0736</td> </tr> <tr> <td>ContiTech<br/>4159 N P05</td> </tr> <tr> <td>GOODYEAR<br/>1R12-761</td> </tr> <tr> <td>VIBRACOUSTIC<br/>V 1 DK 21 B-5</td> </tr> </table>   | Competitor code                | Firestone<br>1T15 M-9<br>W01-M58-0736 | ContiTech<br>4159 N P05 | GOODYEAR<br>1R12-761 | VIBRACOUSTIC<br>V 1 DK 21 B-5    | <p>Piston: No</p>        | <table border="1"> <thead> <tr> <th>Code</th> <th>Manufacturer</th> </tr> </thead> <tbody> <tr> <td> </td> <td> </td> </tr> </tbody> </table>   |  | Code | Manufacturer |              |          |              |          |          |       |          |       |          |     |
| Competitor code   |                                |                                       |                         |                      |                                  |                          |   |  |      |              |              |          |              |          |          |       |          |       |          |     |
| Firestone<br>1T15 M-9<br>W01-M58-0736   |                                |                                       |                         |                      |                                  |                          |   |  |      |              |              |          |              |          |          |       |          |       |          |     |
| ContiTech<br>4159 N P05   |                                |                                       |                         |                      |                                  |                          |   |  |      |              |              |          |              |          |          |       |          |       |          |     |
| GOODYEAR<br>1R12-761  |                                |                                       |                         |                      |                                  |                          |   |  |      |              |              |          |              |          |          |       |          |       |          |     |
| VIBRACOUSTIC<br>V 1 DK 21 B-5   |                                |                                       |                         |                      |                                  |                          |   |  |      |              |              |          |              |          |          |       |          |       |          |     |
| Code  | Manufacturer                   |                                       |                         |                      |                                  |                          |   |  |      |              |              |          |              |          |          |       |          |       |          |     |
|   |                                |                                       |                         |                      |                                  |                          |   |  |      |              |              |          |              |          |          |       |          |       |          |     |
| <b>FM18047.C01P</b>   |                                |                                       |                         |                      |                                  |                          |   |  |      |              |              |          |              |          |          |       |          |       |          |     |
| <table border="1"> <tr> <td>Competitor code</td> </tr> <tr> <td>Firestone<br/>1T15 M-9<br/>W01-M58-7548</td> </tr> <tr> <td>ContiTech<br/>4159 N P14</td> </tr> <tr> <td>GOODYEAR<br/>1R12-760</td> </tr> <tr> <td>VIBRACOUSTIC<br/>V 1 DK 21 B-4</td> </tr> </table>   | Competitor code                | Firestone<br>1T15 M-9<br>W01-M58-7548 | ContiTech<br>4159 N P14 | GOODYEAR<br>1R12-760 | VIBRACOUSTIC<br>V 1 DK 21 B-4    | <p>Piston: Composite</p> | <table border="1"> <thead> <tr> <th>Code</th> <th>Manufacturer</th> </tr> </thead> <tbody> <tr> <td>UJA 0894-001</td> <td>FRUEHAUF</td> </tr> <tr> <td>UJB 0894-001</td> <td>SMB</td> </tr> </tbody> </table>   |  | Code | Manufacturer | UJA 0894-001 | FRUEHAUF | UJB 0894-001 | SMB      |          |       |          |       |          |     |
| Competitor code   |                                |                                       |                         |                      |                                  |                          |   |  |      |              |              |          |              |          |          |       |          |       |          |     |
| Firestone<br>1T15 M-9<br>W01-M58-7548   |                                |                                       |                         |                      |                                  |                          |   |  |      |              |              |          |              |          |          |       |          |       |          |     |
| ContiTech<br>4159 N P14   |                                |                                       |                         |                      |                                  |                          |   |  |      |              |              |          |              |          |          |       |          |       |          |     |
| GOODYEAR<br>1R12-760  |                                |                                       |                         |                      |                                  |                          |   |  |      |              |              |          |              |          |          |       |          |       |          |     |
| VIBRACOUSTIC<br>V 1 DK 21 B-4   |                                |                                       |                         |                      |                                  |                          |   |  |      |              |              |          |              |          |          |       |          |       |          |     |
| Code  | Manufacturer                   |                                       |                         |                      |                                  |                          |   |  |      |              |              |          |              |          |          |       |          |       |          |     |
| UJA 0894-001  | FRUEHAUF                       |                                       |                         |                      |                                  |                          |   |  |      |              |              |          |              |          |          |       |          |       |          |     |
| UJB 0894-001  | SMB                            |                                       |                         |                      |                                  |                          |   |  |      |              |              |          |              |          |          |       |          |       |          |     |
| <b>FM18047.C02</b>  |                                |                                       |                         |                      |                                  |                          |   |  |      |              |              |          |              |          |          |       |          |       |          |     |
| <table border="1"> <tr> <td>Competitor code</td> </tr> <tr> <td>Firestone<br/>1T15M-9<br/>W01-M58-9131</td> </tr> <tr> <td>ContiTech<br/>4159 N P09</td> </tr> <tr> <td>GOODYEAR<br/>1R12-721</td> </tr> <tr> <td>VIBRACOUSTIC<br/>V 1 DK 23 L-9131</td> </tr> </table> | Competitor code                | Firestone<br>1T15M-9<br>W01-M58-9131  | ContiTech<br>4159 N P09 | GOODYEAR<br>1R12-721 | VIBRACOUSTIC<br>V 1 DK 23 L-9131 | <p>Piston: Steel</p>     | <table border="1"> <thead> <tr> <th>Code</th> <th>Manufacturer</th> </tr> </thead> <tbody> <tr> <td>M001774</td> <td>FRUEHAUF</td> </tr> <tr> <td>UJB 0358-001</td> <td>FRUEHAUF</td> </tr> <tr> <td>H2500324</td> <td>SAMRO</td> </tr> <tr> <td>58051210</td> <td>CARDI</td> </tr> <tr> <td>UJB 0358</td> <td>SMB</td> </tr> </tbody> </table> |  | Code | Manufacturer | M001774      | FRUEHAUF | UJB 0358-001 | FRUEHAUF | H2500324 | SAMRO | 58051210 | CARDI | UJB 0358 | SMB |
| Competitor code   |                                |                                       |                         |                      |                                  |                          |   |  |      |              |              |          |              |          |          |       |          |       |          |     |
| Firestone<br>1T15M-9<br>W01-M58-9131  |                                |                                       |                         |                      |                                  |                          |   |  |      |              |              |          |              |          |          |       |          |       |          |     |
| ContiTech<br>4159 N P09   |                                |                                       |                         |                      |                                  |                          |   |  |      |              |              |          |              |          |          |       |          |       |          |     |
| GOODYEAR<br>1R12-721  |                                |                                       |                         |                      |                                  |                          |   |  |      |              |              |          |              |          |          |       |          |       |          |     |
| VIBRACOUSTIC<br>V 1 DK 23 L-9131  |                                |                                       |                         |                      |                                  |                          |   |  |      |              |              |          |              |          |          |       |          |       |          |     |
| Code  | Manufacturer                   |                                       |                         |                      |                                  |                          |   |  |      |              |              |          |              |          |          |       |          |       |          |     |
| M001774   | FRUEHAUF                       |                                       |                         |                      |                                  |                          |   |  |      |              |              |          |              |          |          |       |          |       |          |     |
| UJB 0358-001  | FRUEHAUF                       |                                       |                         |                      |                                  |                          |   |  |      |              |              |          |              |          |          |       |          |       |          |     |
| H2500324  | SAMRO                          |                                       |                         |                      |                                  |                          |   |  |      |              |              |          |              |          |          |       |          |       |          |     |
| 58051210  | CARDI                          |                                       |                         |                      |                                  |                          |   |  |      |              |              |          |              |          |          |       |          |       |          |     |
| UJB 0358  | SMB                            |                                       |                         |                      |                                  |                          |   |  |      |              |              |          |              |          |          |       |          |       |          |     |



# Towing vehicle & Trailer & Semitrailer Air Springs

| Code   | Section, Top View, Bottom View | Applications                          |                         |                      |                                |                      |   |  |      |              |  |          |          |       |  |     |
|--|--------------------------------|---------------------------------------|-------------------------|----------------------|--------------------------------|----------------------|---|--|------|--------------|--|----------|----------|-------|--|-----|
| <b>FM18047.C03</b>   |                                |                                       |                         |                      |                                |                      |   |  |      |              |  |          |          |       |  |     |
| <table border="1"> <tr><td>Competitor code</td></tr> <tr><td>Firestone<br/>1T15 M-9<br/>W01-M58-7548</td></tr> <tr><td>ContiTech<br/>4159 N P03</td></tr> <tr><td>GOODYEAR<br/>1R12-701</td></tr> <tr><td>VIBRACOUSTIC<br/>V 1 DK 23 L-40</td></tr> </table> | Competitor code                | Firestone<br>1T15 M-9<br>W01-M58-7548 | ContiTech<br>4159 N P03 | GOODYEAR<br>1R12-701 | VIBRACOUSTIC<br>V 1 DK 23 L-40 | <p>Piston: Steel</p> | <table border="1"> <tr> <th>Code</th> <th>Manufacturer</th> </tr> <tr> <td></td> <td>FRUEHAUF</td> </tr> <tr> <td>H2500425</td> <td>SAMRO</td> </tr> <tr> <td></td> <td>SMB</td> </tr> </table> |  | Code | Manufacturer |  | FRUEHAUF | H2500425 | SAMRO |  | SMB |
| Competitor code  |                                |                                       |                         |                      |                                |                      |   |  |      |              |  |          |          |       |  |     |
| Firestone<br>1T15 M-9<br>W01-M58-7548  |                                |                                       |                         |                      |                                |                      |   |  |      |              |  |          |          |       |  |     |
| ContiTech<br>4159 N P03  |                                |                                       |                         |                      |                                |                      |   |  |      |              |  |          |          |       |  |     |
| GOODYEAR<br>1R12-701   |                                |                                       |                         |                      |                                |                      |   |  |      |              |  |          |          |       |  |     |
| VIBRACOUSTIC<br>V 1 DK 23 L-40   |                                |                                       |                         |                      |                                |                      |   |  |      |              |  |          |          |       |  |     |
| Code   | Manufacturer                   |                                       |                         |                      |                                |                      |   |  |      |              |  |          |          |       |  |     |
|  | FRUEHAUF                       |                                       |                         |                      |                                |                      |   |  |      |              |  |          |          |       |  |     |
| H2500425   | SAMRO                          |                                       |                         |                      |                                |                      |   |  |      |              |  |          |          |       |  |     |
|  | SMB                            |                                       |                         |                      |                                |                      |   |  |      |              |  |          |          |       |  |     |
| <b>FM18048.H01</b>   |                                |                                       |                         |                      |                                |                      |   |  |      |              |  |          |          |       |  |     |
| <table border="1"> <tr><td>Competitor code</td></tr> <tr><td>Firestone</td></tr> <tr><td>ContiTech<br/>4183 N2</td></tr> <tr><td>GOODYEAR</td></tr> <tr><td>VIBRACOUSTIC</td></tr> </table>  | Competitor code                | Firestone                             | ContiTech<br>4183 N2    | GOODYEAR             | VIBRACOUSTIC                   | <p>Piston: No</p>    | <table border="1"> <tr> <th>Code</th> <th>Manufacturer</th> </tr> <tr> <td></td> <td></td> </tr> </table>   |  | Code | Manufacturer |  |          |          |       |  |     |
| Competitor code  |                                |                                       |                         |                      |                                |                      |   |  |      |              |  |          |          |       |  |     |
| Firestone  |                                |                                       |                         |                      |                                |                      |   |  |      |              |  |          |          |       |  |     |
| ContiTech<br>4183 N2   |                                |                                       |                         |                      |                                |                      |   |  |      |              |  |          |          |       |  |     |
| GOODYEAR   |                                |                                       |                         |                      |                                |                      |   |  |      |              |  |          |          |       |  |     |
| VIBRACOUSTIC   |                                |                                       |                         |                      |                                |                      |   |  |      |              |  |          |          |       |  |     |
| Code   | Manufacturer                   |                                       |                         |                      |                                |                      |   |  |      |              |  |          |          |       |  |     |
|  |                                |                                       |                         |                      |                                |                      |   |  |      |              |  |          |          |       |  |     |
| <b>FM18048.H02</b>   |                                |                                       |                         |                      |                                |                      |   |  |      |              |  |          |          |       |  |     |
| <table border="1"> <tr><td>Competitor code</td></tr> <tr><td>Firestone</td></tr> <tr><td>ContiTech<br/>4183 N1</td></tr> <tr><td>GOODYEAR</td></tr> <tr><td>VIBRACOUSTIC</td></tr> </table>  | Competitor code                | Firestone                             | ContiTech<br>4183 N1    | GOODYEAR             | VIBRACOUSTIC                   | <p>Piston: No</p>    | <table border="1"> <tr> <th>Code</th> <th>Manufacturer</th> </tr> <tr> <td></td> <td></td> </tr> </table>   |  | Code | Manufacturer |  |          |          |       |  |     |
| Competitor code  |                                |                                       |                         |                      |                                |                      |   |  |      |              |  |          |          |       |  |     |
| Firestone  |                                |                                       |                         |                      |                                |                      |   |  |      |              |  |          |          |       |  |     |
| ContiTech<br>4183 N1   |                                |                                       |                         |                      |                                |                      |   |  |      |              |  |          |          |       |  |     |
| GOODYEAR   |                                |                                       |                         |                      |                                |                      |   |  |      |              |  |          |          |       |  |     |
| VIBRACOUSTIC   |                                |                                       |                         |                      |                                |                      |   |  |      |              |  |          |          |       |  |     |
| Code   | Manufacturer                   |                                       |                         |                      |                                |                      |   |  |      |              |  |          |          |       |  |     |
|  |                                |                                       |                         |                      |                                |                      |   |  |      |              |  |          |          |       |  |     |



# Towing vehicle & Trailer & Semitrailer Air Springs

| Code  | Section, Top View, Bottom View | Applications                                |   |                  |                                  |  |  |      |              |  |          |   |                 |                 |                 |                 |               |               |               |   |      |              |  |          |
|---|--------------------------------|---|---|------------------|----------------------------------|--|--|------|--------------|--|----------|---|-----------------|-----------------|-----------------|-----------------|---------------|---------------|---------------|---|------|--------------|--|----------|
| <b>FM18048.C01</b>  |                                |   |   |                  |                                  |  |  |      |              |  |          |   |                 |                 |                 |                 |               |               |               |   |      |              |  |          |
| <table border="1" style="width: 100%; border-collapse: collapse;"> <tr> <td style="padding: 2px;">Competitor code</td> </tr> <tr> <td style="padding: 2px;">Firestone<br/>1R7C-490-340-C<br/>W01-M58-0589</td> </tr> <tr> <td style="padding: 2px;">ContiTech<br/>4183 N P24; 4183<br/>N P22;<br/>4183 N P23; 4183<br/>N P26;<br/>4183 N P28</td> </tr> <tr> <td style="padding: 2px;">GOODYEAR</td> </tr> <tr> <td style="padding: 2px;">VIBRACOUSTIC<br/>V 1 KF 32-23-232</td> </tr> </table> | Competitor code                | Firestone<br>1R7C-490-340-C<br>W01-M58-0589 | ContiTech<br>4183 N P24; 4183<br>N P22;<br>4183 N P23; 4183<br>N P26;<br>4183 N P28 | GOODYEAR         | VIBRACOUSTIC<br>V 1 KF 32-23-232 | <p style="margin-top: 10px;">Piston: Steel</p> | <table border="1" style="width: 100%; border-collapse: collapse;"> <thead> <tr> <th style="padding: 2px;">Code</th> <th style="padding: 2px;">Manufacturer</th> </tr> </thead> <tbody> <tr><td style="padding: 2px;">A 942 320 23 21</td><td rowspan="10" style="text-align: center; vertical-align: middle;">MERCEDES</td></tr> <tr><td style="padding: 2px;">A 942 320 22 21</td></tr> <tr><td style="padding: 2px;">A 942 320 05 57</td></tr> <tr><td style="padding: 2px;">A 942 320 13 21</td></tr> <tr><td style="padding: 2px;">A 942 320 69 21</td></tr> <tr><td style="padding: 2px;">A 942 320 14 21</td></tr> <tr><td style="padding: 2px;">942 320 14 21</td></tr> <tr><td style="padding: 2px;">942 320 23 21</td></tr> <tr><td style="padding: 2px;">942 320 69 21</td></tr> </tbody> </table> | Code | Manufacturer | A 942 320 23 21                              | MERCEDES | A 942 320 22 21   | A 942 320 05 57 | A 942 320 13 21 | A 942 320 69 21 | A 942 320 14 21 | 942 320 14 21 | 942 320 23 21 | 942 320 69 21 | <table border="1" style="width: 100%; border-collapse: collapse;"> <thead> <tr> <th style="padding: 2px;">Code</th> <th style="padding: 2px;">Manufacturer</th> </tr> </thead> <tbody> <tr> <td style="padding: 2px;">A942 3202221<br/>A942 3206821<br/>A942 3201321</td> <td style="text-align: center; vertical-align: middle;">MERCEDES</td> </tr> </tbody> </table> | Code | Manufacturer | A942 3202221<br>A942 3206821<br>A942 3201321 | MERCEDES |
| Competitor code   |                                |   |   |                  |                                  |  |  |      |              |  |          |   |                 |                 |                 |                 |               |               |               |   |      |              |  |          |
| Firestone<br>1R7C-490-340-C<br>W01-M58-0589   |                                |   |   |                  |                                  |  |  |      |              |  |          |   |                 |                 |                 |                 |               |               |               |   |      |              |  |          |
| ContiTech<br>4183 N P24; 4183<br>N P22;<br>4183 N P23; 4183<br>N P26;<br>4183 N P28   |                                |   |   |                  |                                  |  |  |      |              |  |          |   |                 |                 |                 |                 |               |               |               |   |      |              |  |          |
| GOODYEAR  |                                |   |   |                  |                                  |  |  |      |              |  |          |   |                 |                 |                 |                 |               |               |               |   |      |              |  |          |
| VIBRACOUSTIC<br>V 1 KF 32-23-232  |                                |   |   |                  |                                  |  |  |      |              |  |          |   |                 |                 |                 |                 |               |               |               |   |      |              |  |          |
| Code  | Manufacturer                   |   |   |                  |                                  |  |  |      |              |  |          |   |                 |                 |                 |                 |               |               |               |   |      |              |  |          |
| A 942 320 23 21   | MERCEDES                       |   |   |                  |                                  |  |  |      |              |  |          |   |                 |                 |                 |                 |               |               |               |   |      |              |  |          |
| A 942 320 22 21   |                                |   |   |                  |                                  |  |  |      |              |  |          |   |                 |                 |                 |                 |               |               |               |   |      |              |  |          |
| A 942 320 05 57   |                                |   |   |                  |                                  |  |  |      |              |  |          |   |                 |                 |                 |                 |               |               |               |   |      |              |  |          |
| A 942 320 13 21   |                                |   |   |                  |                                  |  |  |      |              |  |          |   |                 |                 |                 |                 |               |               |               |   |      |              |  |          |
| A 942 320 69 21   |                                |   |   |                  |                                  |  |  |      |              |  |          |   |                 |                 |                 |                 |               |               |               |   |      |              |  |          |
| A 942 320 14 21   |                                |   |   |                  |                                  |  |  |      |              |  |          |   |                 |                 |                 |                 |               |               |               |   |      |              |  |          |
| 942 320 14 21   |                                |   |   |                  |                                  |  |  |      |              |  |          |   |                 |                 |                 |                 |               |               |               |   |      |              |  |          |
| 942 320 23 21   |                                |   |   |                  |                                  |  |  |      |              |  |          |   |                 |                 |                 |                 |               |               |               |   |      |              |  |          |
| 942 320 69 21   |                                |   |   |                  |                                  |  |  |      |              |  |          |   |                 |                 |                 |                 |               |               |               |   |      |              |  |          |
| Code  |                                | Manufacturer                                |   |                  |                                  |  |  |      |              |  |          |   |                 |                 |                 |                 |               |               |               |   |      |              |  |          |
| A942 3202221<br>A942 3206821<br>A942 3201321  | MERCEDES                       |   |   |                  |                                  |  |  |      |              |  |          |   |                 |                 |                 |                 |               |               |               |   |      |              |  |          |
| <b>FM18048.C02</b>  |                                |   |   |                  |                                  |  |  |      |              |  |          |   |                 |                 |                 |                 |               |               |               |   |      |              |  |          |
| <table border="1" style="width: 100%; border-collapse: collapse;"> <tr> <td style="padding: 2px;">Competitor code</td> </tr> <tr> <td style="padding: 2px;">Firestone</td> </tr> <tr> <td style="padding: 2px;">ContiTech<br/>4183 N P23;<br/>4183 N P25</td> </tr> <tr> <td style="padding: 2px;">GOODYEAR<br/>9567</td> </tr> <tr> <td style="padding: 2px;">VIBRACOUSTIC</td> </tr> </table>   | Competitor code                | Firestone                                   | ContiTech<br>4183 N P23;<br>4183 N P25  | GOODYEAR<br>9567 | VIBRACOUSTIC                     | <p style="margin-top: 10px;">Piston: Steel</p> | <table border="1" style="width: 100%; border-collapse: collapse;"> <thead> <tr> <th style="padding: 2px;">Code</th> <th style="padding: 2px;">Manufacturer</th> </tr> </thead> <tbody> <tr> <td style="padding: 2px;">A942 3202221<br/>A942 3206821<br/>A942 3201321</td> <td style="text-align: center; vertical-align: middle;">MERCEDES</td> </tr> </tbody> </table>  | Code | Manufacturer | A942 3202221<br>A942 3206821<br>A942 3201321 | MERCEDES | <table border="1" style="width: 100%; border-collapse: collapse;"> <thead> <tr> <th style="padding: 2px;">Code</th> <th style="padding: 2px;">Manufacturer</th> </tr> </thead> <tbody> <tr> <td style="padding: 2px;"></td> <td style="padding: 2px;"></td> </tr> </tbody> </table> | Code            | Manufacturer    |                 |                 |               |               |               |   |      |              |  |          |
| Competitor code   |                                |   |   |                  |                                  |  |  |      |              |  |          |   |                 |                 |                 |                 |               |               |               |   |      |              |  |          |
| Firestone   |                                |   |   |                  |                                  |  |  |      |              |  |          |   |                 |                 |                 |                 |               |               |               |   |      |              |  |          |
| ContiTech<br>4183 N P23;<br>4183 N P25  |                                |   |   |                  |                                  |  |  |      |              |  |          |   |                 |                 |                 |                 |               |               |               |   |      |              |  |          |
| GOODYEAR<br>9567  |                                |   |   |                  |                                  |  |  |      |              |  |          |   |                 |                 |                 |                 |               |               |               |   |      |              |  |          |
| VIBRACOUSTIC  |                                |   |   |                  |                                  |  |  |      |              |  |          |   |                 |                 |                 |                 |               |               |               |   |      |              |  |          |
| Code  | Manufacturer                   |   |   |                  |                                  |  |  |      |              |  |          |   |                 |                 |                 |                 |               |               |               |   |      |              |  |          |
| A942 3202221<br>A942 3206821<br>A942 3201321  | MERCEDES                       |   |   |                  |                                  |  |  |      |              |  |          |   |                 |                 |                 |                 |               |               |               |   |      |              |  |          |
| Code  | Manufacturer                   |   |   |                  |                                  |  |  |      |              |  |          |   |                 |                 |                 |                 |               |               |               |   |      |              |  |          |
|   |                                |   |   |                  |                                  |  |  |      |              |  |          |   |                 |                 |                 |                 |               |               |               |   |      |              |  |          |
| <b>FM18049.H01</b>  |                                |   |   |                  |                                  |  |  |      |              |  |          |   |                 |                 |                 |                 |               |               |               |   |      |              |  |          |
| <table border="1" style="width: 100%; border-collapse: collapse;"> <tr> <td style="padding: 2px;">Competitor code</td> </tr> <tr> <td style="padding: 2px;">Firestone</td> </tr> <tr> <td style="padding: 2px;">ContiTech<br/>4571 N</td> </tr> <tr> <td style="padding: 2px;">GOODYEAR</td> </tr> <tr> <td style="padding: 2px;">VIBRACOUSTIC</td> </tr> </table>  | Competitor code                | Firestone                                   | ContiTech<br>4571 N   | GOODYEAR         | VIBRACOUSTIC                     | <p style="margin-top: 10px;">Piston: No</p>    | <table border="1" style="width: 100%; border-collapse: collapse;"> <thead> <tr> <th style="padding: 2px;">Code</th> <th style="padding: 2px;">Manufacturer</th> </tr> </thead> <tbody> <tr> <td style="padding: 2px;"></td> <td style="padding: 2px;"></td> </tr> </tbody> </table>  | Code | Manufacturer |  |          | <table border="1" style="width: 100%; border-collapse: collapse;"> <thead> <tr> <th style="padding: 2px;">Code</th> <th style="padding: 2px;">Manufacturer</th> </tr> </thead> <tbody> <tr> <td style="padding: 2px;"></td> <td style="padding: 2px;"></td> </tr> </tbody> </table> | Code            | Manufacturer    |                 |                 |               |               |               |   |      |              |  |          |
| Competitor code   |                                |   |   |                  |                                  |  |  |      |              |  |          |   |                 |                 |                 |                 |               |               |               |   |      |              |  |          |
| Firestone   |                                |   |   |                  |                                  |  |  |      |              |  |          |   |                 |                 |                 |                 |               |               |               |   |      |              |  |          |
| ContiTech<br>4571 N   |                                |   |   |                  |                                  |  |  |      |              |  |          |   |                 |                 |                 |                 |               |               |               |   |      |              |  |          |
| GOODYEAR  |                                |   |   |                  |                                  |  |  |      |              |  |          |   |                 |                 |                 |                 |               |               |               |   |      |              |  |          |
| VIBRACOUSTIC  |                                |   |   |                  |                                  |  |  |      |              |  |          |   |                 |                 |                 |                 |               |               |               |   |      |              |  |          |
| Code  | Manufacturer                   |   |   |                  |                                  |  |  |      |              |  |          |   |                 |                 |                 |                 |               |               |               |   |      |              |  |          |
|   |                                |   |   |                  |                                  |  |  |      |              |  |          |   |                 |                 |                 |                 |               |               |               |   |      |              |  |          |
| Code  | Manufacturer                   |   |   |                  |                                  |  |  |      |              |  |          |   |                 |                 |                 |                 |               |               |               |   |      |              |  |          |
|   |                                |   |   |                  |                                  |  |  |      |              |  |          |   |                 |                 |                 |                 |               |               |               |   |      |              |  |          |



# Towing vehicle & Trailer & Semitrailer Air Springs

| Code   | Section, Top View, Bottom View | Applications                           |                               |                      |              |                          |  |  |      |              |            |             |            |          |          |
|--|--------------------------------|--|-------------------------------|----------------------|--------------|--------------------------|--|--|------|--------------|------------|-------------|------------|----------|----------|
| <b>FM18049.C01</b>   |                                |  |                               |                      |              |                          |  |  |      |              |            |             |            |          |          |
| <table border="1"> <tr><td>Competitor code</td></tr> <tr><td>Firestone<br/>W01-M58-8546</td></tr> <tr><td>ContiTech<br/>4571 N P02</td></tr> <tr><td>GOODYEAR</td></tr> <tr><td>VIBRACOUSTIC</td></tr> </table>                                  | Competitor code                | Firestone<br>W01-M58-8546              | ContiTech<br>4571 N P02       | GOODYEAR             | VIBRACOUSTIC | <p>Piston: Steel</p>     | <table border="1"> <thead> <tr> <th>Code</th> <th>Manufacturer</th> </tr> </thead> <tbody> <tr> <td>21 224 750</td> <td rowspan="2">Volvo</td> </tr> <tr> <td>22 056 630</td> </tr> </tbody> </table>  |  | Code | Manufacturer | 21 224 750 | Volvo       | 22 056 630 |          |          |
| Competitor code  |                                |  |                               |                      |              |                          |  |  |      |              |            |             |            |          |          |
| Firestone<br>W01-M58-8546  |                                |  |                               |                      |              |                          |  |  |      |              |            |             |            |          |          |
| ContiTech<br>4571 N P02  |                                |  |                               |                      |              |                          |  |  |      |              |            |             |            |          |          |
| GOODYEAR   |                                |  |                               |                      |              |                          |  |  |      |              |            |             |            |          |          |
| VIBRACOUSTIC   |                                |  |                               |                      |              |                          |  |  |      |              |            |             |            |          |          |
| Code   | Manufacturer                   |  |                               |                      |              |                          |  |  |      |              |            |             |            |          |          |
| 21 224 750   | Volvo                          |  |                               |                      |              |                          |  |  |      |              |            |             |            |          |          |
| 22 056 630   |                                |  |                               |                      |              |                          |  |  |      |              |            |             |            |          |          |
| <b>FM18050.H01</b>   |                                |  |                               |                      |              |                          |  |  |      |              |            |             |            |          |          |
| <table border="1"> <tr><td>Competitor code</td></tr> <tr><td>Firestone</td></tr> <tr><td>ContiTech</td></tr> <tr><td>GOODYEAR</td></tr> <tr><td>VIBRACOUSTIC</td></tr> </table>  | Competitor code                | Firestone                              | ContiTech                     | GOODYEAR             | VIBRACOUSTIC | <p>Piston: No</p>        | <table border="1"> <thead> <tr> <th>Code</th> <th>Manufacturer</th> </tr> </thead> <tbody> <tr> <td></td> <td>HENDRICKSON</td> </tr> <tr> <td></td> <td>NAVISTAR</td> </tr> </tbody> </table>  |  | Code | Manufacturer |            | HENDRICKSON |            | NAVISTAR |          |
| Competitor code  |                                |  |                               |                      |              |                          |  |  |      |              |            |             |            |          |          |
| Firestone  |                                |  |                               |                      |              |                          |  |  |      |              |            |             |            |          |          |
| ContiTech  |                                |  |                               |                      |              |                          |  |  |      |              |            |             |            |          |          |
| GOODYEAR   |                                |  |                               |                      |              |                          |  |  |      |              |            |             |            |          |          |
| VIBRACOUSTIC   |                                |  |                               |                      |              |                          |  |  |      |              |            |             |            |          |          |
| Code   | Manufacturer                   |  |                               |                      |              |                          |  |  |      |              |            |             |            |          |          |
|  | HENDRICKSON                    |  |                               |                      |              |                          |  |  |      |              |            |             |            |          |          |
|  | NAVISTAR                       |  |                               |                      |              |                          |  |  |      |              |            |             |            |          |          |
| <b>FM18050.C01P</b>  |                                |  |                               |                      |              |                          |  |  |      |              |            |             |            |          |          |
| <table border="1"> <tr><td>Competitor code</td></tr> <tr><td>Firestone<br/>1T17 CA-5<br/>W01-358-8709</td></tr> <tr><td>ContiTech<br/>10 10.5-15 P 460</td></tr> <tr><td>GOODYEAR<br/>1R13-159</td></tr> <tr><td>VIBRACOUSTIC</td></tr> </table> | Competitor code                | Firestone<br>1T17 CA-5<br>W01-358-8709 | ContiTech<br>10 10.5-15 P 460 | GOODYEAR<br>1R13-159 | VIBRACOUSTIC | <p>Piston: Composite</p> | <table border="1"> <thead> <tr> <th>Code</th> <th>Manufacturer</th> </tr> </thead> <tbody> <tr> <td>S-20900</td> <td rowspan="2">HENDRICKSON</td> </tr> <tr> <td>S-21800</td> </tr> <tr> <td></td> <td>NAVISTAR</td> </tr> </tbody> </table> |  | Code | Manufacturer | S-20900    | HENDRICKSON | S-21800    |          | NAVISTAR |
| Competitor code  |                                |  |                               |                      |              |                          |  |  |      |              |            |             |            |          |          |
| Firestone<br>1T17 CA-5<br>W01-358-8709   |                                |  |                               |                      |              |                          |  |  |      |              |            |             |            |          |          |
| ContiTech<br>10 10.5-15 P 460  |                                |  |                               |                      |              |                          |  |  |      |              |            |             |            |          |          |
| GOODYEAR<br>1R13-159   |                                |  |                               |                      |              |                          |  |  |      |              |            |             |            |          |          |
| VIBRACOUSTIC   |                                |  |                               |                      |              |                          |  |  |      |              |            |             |            |          |          |
| Code   | Manufacturer                   |  |                               |                      |              |                          |  |  |      |              |            |             |            |          |          |
| S-20900  | HENDRICKSON                    |  |                               |                      |              |                          |  |  |      |              |            |             |            |          |          |
| S-21800  |                                |  |                               |                      |              |                          |  |  |      |              |            |             |            |          |          |
|  | NAVISTAR                       |  |                               |                      |              |                          |  |  |      |              |            |             |            |          |          |



# Towing vehicle & Trailer & Semitrailer Air Springs

| Code   | Section, Top View, Bottom View | Applications                             |   |                      |              |  |  |  |      |              |                  |             |          |          |
|--|--------------------------------|--|---|----------------------|--------------|--|--|--|------|--------------|------------------|-------------|----------|----------|
| <b>FM18051.C01P</b>  |                                |  |   |                      |              |  |  |  |      |              |                  |             |          |          |
| <table border="1"> <tr> <td>Competitor code</td> </tr> <tr> <td>Firestone<br/>1T17 CA-6.5<br/>W01-358-8708</td> </tr> <tr> <td>ContiTech<br/>10 10-16 P 526</td> </tr> <tr> <td>GOODYEAR<br/>1R13-177</td> </tr> <tr> <td>VIBRACOUSTIC</td> </tr> </table> | Competitor code                | Firestone<br>1T17 CA-6.5<br>W01-358-8708 | ContiTech<br>10 10-16 P 526               | GOODYEAR<br>1R13-177 | VIBRACOUSTIC | <p>2x 1/4-18 NPTF<br/>2x 3/4-16 UNF-2A</p> <p>DEF FM18051</p> <p>Ø230<br/>Ø340 (max. Ø350)</p> <p>172-13 UNC</p>   | <table border="1"> <thead> <tr> <th>Code</th> <th>Manufacturer</th> </tr> </thead> <tbody> <tr> <td>S-21966<br/>28929</td> <td>HENDRICKSON</td> </tr> <tr> <td>1R13-250</td> <td>NAVISTAR</td> </tr> </tbody> </table> |  | Code | Manufacturer | S-21966<br>28929 | HENDRICKSON | 1R13-250 | NAVISTAR |
| Competitor code  |                                |  |   |                      |              |  |  |  |      |              |                  |             |          |          |
| Firestone<br>1T17 CA-6.5<br>W01-358-8708   |                                |  |   |                      |              |  |  |  |      |              |                  |             |          |          |
| ContiTech<br>10 10-16 P 526  |                                |  |   |                      |              |  |  |  |      |              |                  |             |          |          |
| GOODYEAR<br>1R13-177   |                                |  |   |                      |              |  |  |  |      |              |                  |             |          |          |
| VIBRACOUSTIC   |                                |  |   |                      |              |  |  |  |      |              |                  |             |          |          |
| Code   | Manufacturer                   |  |   |                      |              |  |  |  |      |              |                  |             |          |          |
| S-21966<br>28929   | HENDRICKSON                    |  |   |                      |              |  |  |  |      |              |                  |             |          |          |
| 1R13-250   | NAVISTAR                       |  |   |                      |              |  |  |  |      |              |                  |             |          |          |
| Piston: Composite  |                                |  |   |                      |              |  |  |  |      |              |                  |             |          |          |
| <b>FM18052.H01</b>   |                                |  |   |                      |              |  |  |  |      |              |                  |             |          |          |
| <table border="1"> <tr> <td>Competitor code</td> </tr> <tr> <td>Firestone</td> </tr> <tr> <td>ContiTech<br/>6122NP46<br/>(without piston)</td> </tr> <tr> <td>GOODYEAR</td> </tr> <tr> <td>VIBRACOUSTIC</td> </tr> </table>                                | Competitor code                | Firestone                                | ContiTech<br>6122NP46<br>(without piston) | GOODYEAR             | VIBRACOUSTIC | <p>DEF FM18052</p> <p>Ø229</p> <p>473</p> <p>12</p> <p>Ø130.6</p> <p>45</p> <p>90</p> <p>Ø260</p> <p>M22X1.5</p> <p>Ø5</p>                                       | <table border="1"> <thead> <tr> <th>Code</th> <th>Manufacturer</th> </tr> </thead> <tbody> <tr> <td> </td> <td> </td> </tr> </tbody> </table>  |  | Code | Manufacturer |                  |             |          |          |
| Competitor code  |                                |  |   |                      |              |  |  |  |      |              |                  |             |          |          |
| Firestone  |                                |  |   |                      |              |  |  |  |      |              |                  |             |          |          |
| ContiTech<br>6122NP46<br>(without piston)  |                                |  |   |                      |              |  |  |  |      |              |                  |             |          |          |
| GOODYEAR   |                                |  |   |                      |              |  |  |  |      |              |                  |             |          |          |
| VIBRACOUSTIC   |                                |  |   |                      |              |  |  |  |      |              |                  |             |          |          |
| Code   | Manufacturer                   |  |   |                      |              |  |  |  |      |              |                  |             |          |          |
|  |                                |  |   |                      |              |  |  |  |      |              |                  |             |          |          |
| Piston: No   |                                |  |   |                      |              |  |  |  |      |              |                  |             |          |          |
| <b>FM18052.H02</b>   |                                |  |   |                      |              |  |  |  |      |              |                  |             |          |          |
| <table border="1"> <tr> <td>Competitor code</td> </tr> <tr> <td>Firestone</td> </tr> <tr> <td>ContiTech<br/>6122NP47<br/>(without piston)</td> </tr> <tr> <td>GOODYEAR</td> </tr> <tr> <td>VIBRACOUSTIC</td> </tr> </table>                                | Competitor code                | Firestone                                | ContiTech<br>6122NP47<br>(without piston) | GOODYEAR             | VIBRACOUSTIC | <p>DEF FM18052</p> <p>Ø229</p> <p>473</p> <p>12</p> <p>Ø130.6</p> <p>90</p> <p>135</p> <p>180</p> <p>Ø259</p> <p>Ø5</p> <p>M22x1.5</p> <p>Ø32</p> <p>M16x1.5</p> | <table border="1"> <thead> <tr> <th>Code</th> <th>Manufacturer</th> </tr> </thead> <tbody> <tr> <td> </td> <td> </td> </tr> </tbody> </table>  |  | Code | Manufacturer |                  |             |          |          |
| Competitor code  |                                |  |   |                      |              |  |  |  |      |              |                  |             |          |          |
| Firestone  |                                |  |   |                      |              |  |  |  |      |              |                  |             |          |          |
| ContiTech<br>6122NP47<br>(without piston)  |                                |  |   |                      |              |  |  |  |      |              |                  |             |          |          |
| GOODYEAR   |                                |  |   |                      |              |  |  |  |      |              |                  |             |          |          |
| VIBRACOUSTIC   |                                |  |   |                      |              |  |  |  |      |              |                  |             |          |          |
| Code   | Manufacturer                   |  |   |                      |              |  |  |  |      |              |                  |             |          |          |
|  |                                |  |   |                      |              |  |  |  |      |              |                  |             |          |          |
| Piston: No   |                                |  |   |                      |              |  |  |  |      |              |                  |             |          |          |



# Towing vehicle & Trailer & Semitrailer Air Springs

| Code   | Section, Top View, Bottom View | Applications |                      |          |              |                          |  |      |              |                 |          |                 |                 |                 |
|--|--------------------------------|--------------|----------------------|----------|--------------|--------------------------|--|------|--------------|-----------------|----------|-----------------|-----------------|-----------------|
| <b>FM18052.C01</b>   |                                |              |                      |          |              |                          |  |      |              |                 |          |                 |                 |                 |
| <table border="1"> <tr><td>Competitor code</td></tr> <tr><td>Firestone</td></tr> <tr><td>ContiTech 6122 N P46</td></tr> <tr><td>GOODYEAR</td></tr> <tr><td>VIBRACOUSTIC</td></tr> </table> | Competitor code                | Firestone    | ContiTech 6122 N P46 | GOODYEAR | VIBRACOUSTIC | <p>Piston: Steel</p>     | <table border="1"> <thead> <tr> <th>Code</th> <th>Manufacturer</th> </tr> </thead> <tbody> <tr> <td>A 960 320 00 57</td> <td rowspan="3">MERCEDES</td> </tr> <tr> <td>A 960 320 70 21</td> </tr> <tr> <td>A 960 320 67 57</td> </tr> </tbody> </table>                                     | Code | Manufacturer | A 960 320 00 57 | MERCEDES | A 960 320 70 21 | A 960 320 67 57 |                 |
| Competitor code  |                                |              |                      |          |              |                          |  |      |              |                 |          |                 |                 |                 |
| Firestone  |                                |              |                      |          |              |                          |  |      |              |                 |          |                 |                 |                 |
| ContiTech 6122 N P46   |                                |              |                      |          |              |                          |  |      |              |                 |          |                 |                 |                 |
| GOODYEAR   |                                |              |                      |          |              |                          |  |      |              |                 |          |                 |                 |                 |
| VIBRACOUSTIC   |                                |              |                      |          |              |                          |  |      |              |                 |          |                 |                 |                 |
| Code   | Manufacturer                   |              |                      |          |              |                          |  |      |              |                 |          |                 |                 |                 |
| A 960 320 00 57  | MERCEDES                       |              |                      |          |              |                          |  |      |              |                 |          |                 |                 |                 |
| A 960 320 70 21  |                                |              |                      |          |              |                          |  |      |              |                 |          |                 |                 |                 |
| A 960 320 67 57  |                                |              |                      |          |              |                          |  |      |              |                 |          |                 |                 |                 |
| <b>FM18052.C02P</b>  |                                |              |                      |          |              |                          |  |      |              |                 |          |                 |                 |                 |
| <table border="1"> <tr><td>Competitor code</td></tr> <tr><td>Firestone</td></tr> <tr><td>ContiTech 6122 N P46</td></tr> <tr><td>GOODYEAR</td></tr> <tr><td>VIBRACOUSTIC</td></tr> </table> | Competitor code                | Firestone    | ContiTech 6122 N P46 | GOODYEAR | VIBRACOUSTIC | <p>Piston: Composite</p> | <table border="1"> <thead> <tr> <th>Code</th> <th>Manufacturer</th> </tr> </thead> <tbody> <tr> <td>A 960 320 00 57</td> <td rowspan="4">MERCEDES</td> </tr> <tr> <td>A 960 320 70 21</td> </tr> <tr> <td>A 960 320 67 57</td> </tr> <tr> <td>A 960 320 51 57</td> </tr> </tbody> </table> | Code | Manufacturer | A 960 320 00 57 | MERCEDES | A 960 320 70 21 | A 960 320 67 57 | A 960 320 51 57 |
| Competitor code  |                                |              |                      |          |              |                          |  |      |              |                 |          |                 |                 |                 |
| Firestone  |                                |              |                      |          |              |                          |  |      |              |                 |          |                 |                 |                 |
| ContiTech 6122 N P46   |                                |              |                      |          |              |                          |  |      |              |                 |          |                 |                 |                 |
| GOODYEAR   |                                |              |                      |          |              |                          |  |      |              |                 |          |                 |                 |                 |
| VIBRACOUSTIC   |                                |              |                      |          |              |                          |  |      |              |                 |          |                 |                 |                 |
| Code   | Manufacturer                   |              |                      |          |              |                          |  |      |              |                 |          |                 |                 |                 |
| A 960 320 00 57  | MERCEDES                       |              |                      |          |              |                          |  |      |              |                 |          |                 |                 |                 |
| A 960 320 70 21  |                                |              |                      |          |              |                          |  |      |              |                 |          |                 |                 |                 |
| A 960 320 67 57  |                                |              |                      |          |              |                          |  |      |              |                 |          |                 |                 |                 |
| A 960 320 51 57  |                                |              |                      |          |              |                          |  |      |              |                 |          |                 |                 |                 |
| <b>FM18052.C03</b>   |                                |              |                      |          |              |                          |  |      |              |                 |          |                 |                 |                 |
| <table border="1"> <tr><td>Competitor code</td></tr> <tr><td>Firestone</td></tr> <tr><td>ContiTech 6122 N P47</td></tr> <tr><td>GOODYEAR</td></tr> <tr><td>VIBRACOUSTIC</td></tr> </table> | Competitor code                | Firestone    | ContiTech 6122 N P47 | GOODYEAR | VIBRACOUSTIC | <p>Piston: Steel</p>     | <table border="1"> <thead> <tr> <th>Code</th> <th>Manufacturer</th> </tr> </thead> <tbody> <tr> <td>A 960 320 01 57</td> <td rowspan="3">MERCEDES</td> </tr> <tr> <td>A 960 320 77 21</td> </tr> <tr> <td>A 960 320 68 57</td> </tr> </tbody> </table>                                     | Code | Manufacturer | A 960 320 01 57 | MERCEDES | A 960 320 77 21 | A 960 320 68 57 |                 |
| Competitor code  |                                |              |                      |          |              |                          |  |      |              |                 |          |                 |                 |                 |
| Firestone  |                                |              |                      |          |              |                          |  |      |              |                 |          |                 |                 |                 |
| ContiTech 6122 N P47   |                                |              |                      |          |              |                          |  |      |              |                 |          |                 |                 |                 |
| GOODYEAR   |                                |              |                      |          |              |                          |  |      |              |                 |          |                 |                 |                 |
| VIBRACOUSTIC   |                                |              |                      |          |              |                          |  |      |              |                 |          |                 |                 |                 |
| Code   | Manufacturer                   |              |                      |          |              |                          |  |      |              |                 |          |                 |                 |                 |
| A 960 320 01 57  | MERCEDES                       |              |                      |          |              |                          |  |      |              |                 |          |                 |                 |                 |
| A 960 320 77 21  |                                |              |                      |          |              |                          |  |      |              |                 |          |                 |                 |                 |
| A 960 320 68 57  |                                |              |                      |          |              |                          |  |      |              |                 |          |                 |                 |                 |



# Towing vehicle & Trailer & Semitrailer Air Springs

| Code  | Section, Top View, Bottom View | Applications |                       |          |                          |                          |  |  |      |              |                 |          |                 |                 |                 |
|---|--------------------------------|--------------|-----------------------|----------|--------------------------|--------------------------|--|--|------|--------------|-----------------|----------|-----------------|-----------------|-----------------|
| <b>FM18052.C04P</b>   |                                |              |                       |          |                          |                          |  |  |      |              |                 |          |                 |                 |                 |
| <table border="1"> <tr><td>Competitor code</td></tr> <tr><td>Firestone</td></tr> <tr><td>ContiTech 6122 N P47</td></tr> <tr><td>GOODYEAR</td></tr> <tr><td>VIBRACOUSTIC</td></tr> </table>              | Competitor code                | Firestone    | ContiTech 6122 N P47  | GOODYEAR | VIBRACOUSTIC             | <p>Piston: Composite</p> | <table border="1"> <thead> <tr> <th>Code</th> <th>Manufacturer</th> </tr> </thead> <tbody> <tr> <td>A 960 320 01 57</td> <td rowspan="4">MERCEDES</td> </tr> <tr> <td>A 960 320 50 57</td> </tr> <tr> <td>A 960 320 68 57</td> </tr> <tr> <td>A 960 320 77 21</td> </tr> </tbody> </table> |  | Code | Manufacturer | A 960 320 01 57 | MERCEDES | A 960 320 50 57 | A 960 320 68 57 | A 960 320 77 21 |
| Competitor code   |                                |              |                       |          |                          |                          |  |  |      |              |                 |          |                 |                 |                 |
| Firestone   |                                |              |                       |          |                          |                          |  |  |      |              |                 |          |                 |                 |                 |
| ContiTech 6122 N P47  |                                |              |                       |          |                          |                          |  |  |      |              |                 |          |                 |                 |                 |
| GOODYEAR  |                                |              |                       |          |                          |                          |  |  |      |              |                 |          |                 |                 |                 |
| VIBRACOUSTIC  |                                |              |                       |          |                          |                          |  |  |      |              |                 |          |                 |                 |                 |
| Code  | Manufacturer                   |              |                       |          |                          |                          |  |  |      |              |                 |          |                 |                 |                 |
| A 960 320 01 57   | MERCEDES                       |              |                       |          |                          |                          |  |  |      |              |                 |          |                 |                 |                 |
| A 960 320 50 57   |                                |              |                       |          |                          |                          |  |  |      |              |                 |          |                 |                 |                 |
| A 960 320 68 57   |                                |              |                       |          |                          |                          |  |  |      |              |                 |          |                 |                 |                 |
| A 960 320 77 21   |                                |              |                       |          |                          |                          |  |  |      |              |                 |          |                 |                 |                 |
| <b>FM18057.H01</b>  |                                |              |                       |          |                          |                          |  |  |      |              |                 |          |                 |                 |                 |
| <table border="1"> <tr><td>Competitor code</td></tr> <tr><td>Firestone</td></tr> <tr><td>ContiTech 4705 N1 P01</td></tr> <tr><td>GOODYEAR</td></tr> <tr><td>VIBRACOUSTIC</td></tr> </table>             | Competitor code                | Firestone    | ContiTech 4705 N1 P01 | GOODYEAR | VIBRACOUSTIC             | <p>Piston: No</p>        | <table border="1"> <thead> <tr> <th>Code</th> <th>Manufacturer</th> </tr> </thead> <tbody> <tr> <td>81.43601.0155</td> <td>MAN</td> </tr> </tbody> </table>  |  | Code | Manufacturer | 81.43601.0155   | MAN      |                 |                 |                 |
| Competitor code   |                                |              |                       |          |                          |                          |  |  |      |              |                 |          |                 |                 |                 |
| Firestone   |                                |              |                       |          |                          |                          |  |  |      |              |                 |          |                 |                 |                 |
| ContiTech 4705 N1 P01   |                                |              |                       |          |                          |                          |  |  |      |              |                 |          |                 |                 |                 |
| GOODYEAR  |                                |              |                       |          |                          |                          |  |  |      |              |                 |          |                 |                 |                 |
| VIBRACOUSTIC  |                                |              |                       |          |                          |                          |  |  |      |              |                 |          |                 |                 |                 |
| Code  | Manufacturer                   |              |                       |          |                          |                          |  |  |      |              |                 |          |                 |                 |                 |
| 81.43601.0155   | MAN                            |              |                       |          |                          |                          |  |  |      |              |                 |          |                 |                 |                 |
| <b>FM18057.C01</b>  |                                |              |                       |          |                          |                          |  |  |      |              |                 |          |                 |                 |                 |
| <table border="1"> <tr><td>Competitor code</td></tr> <tr><td>Firestone</td></tr> <tr><td>ContiTech 4705 N1 P03</td></tr> <tr><td>GOODYEAR</td></tr> <tr><td>VIBRACOUSTIC V 1 DF 26-1</td></tr> </table> | Competitor code                | Firestone    | ContiTech 4705 N1 P03 | GOODYEAR | VIBRACOUSTIC V 1 DF 26-1 | <p>Piston: Steel</p>     | <table border="1"> <thead> <tr> <th>Code</th> <th>Manufacturer</th> </tr> </thead> <tbody> <tr> <td>81.43600.6039</td> <td>MAN</td> </tr> </tbody> </table>  |  | Code | Manufacturer | 81.43600.6039   | MAN      |                 |                 |                 |
| Competitor code   |                                |              |                       |          |                          |                          |  |  |      |              |                 |          |                 |                 |                 |
| Firestone   |                                |              |                       |          |                          |                          |  |  |      |              |                 |          |                 |                 |                 |
| ContiTech 4705 N1 P03   |                                |              |                       |          |                          |                          |  |  |      |              |                 |          |                 |                 |                 |
| GOODYEAR  |                                |              |                       |          |                          |                          |  |  |      |              |                 |          |                 |                 |                 |
| VIBRACOUSTIC V 1 DF 26-1  |                                |              |                       |          |                          |                          |  |  |      |              |                 |          |                 |                 |                 |
| Code  | Manufacturer                   |              |                       |          |                          |                          |  |  |      |              |                 |          |                 |                 |                 |
| 81.43600.6039   | MAN                            |              |                       |          |                          |                          |  |  |      |              |                 |          |                 |                 |                 |



# Towing vehicle & Trailer & Semitrailer Air Springs

| Code  | Section, Top View, Bottom View | Applications                              |                          |          |                             |                      |   |  |      |              |               |     |
|---|--------------------------------|---|--------------------------|----------|-----------------------------|----------------------|---|--|------|--------------|---------------|-----|
| <b>FM18052.C01</b>  |                                |   |                          |          |                             |                      |   |  |      |              |               |     |
| <table border="1"> <tr> <td data-bbox="161 422 376 487">Competitor code</td> </tr> <tr> <td data-bbox="161 487 376 584">Firestone<br/>1T17 AR-10.5<br/>W01-M58-8376</td> </tr> <tr> <td data-bbox="161 584 376 655">ContiTech<br/>4705 N1 P04</td> </tr> <tr> <td data-bbox="161 655 376 726">GOODYEAR</td> </tr> <tr> <td data-bbox="161 726 376 789">VIBRACOUSTIC<br/>V 1 DF 26-2</td> </tr> </table> | Competitor code                | Firestone<br>1T17 AR-10.5<br>W01-M58-8376 | ContiTech<br>4705 N1 P04 | GOODYEAR | VIBRACOUSTIC<br>V 1 DF 26-2 | <p>Piston: Steel</p> | <table border="1"> <tr> <td data-bbox="954 422 1177 487">Code</td> <td data-bbox="1177 422 1441 487">Manufacturer</td> </tr> <tr> <td data-bbox="954 487 1177 551">81.43600.6040</td> <td data-bbox="1177 487 1441 551">MAN</td> </tr> </table> |  | Code | Manufacturer | 81.43600.6040 | MAN |
| Competitor code   |                                |   |                          |          |                             |                      |   |  |      |              |               |     |
| Firestone<br>1T17 AR-10.5<br>W01-M58-8376   |                                |   |                          |          |                             |                      |   |  |      |              |               |     |
| ContiTech<br>4705 N1 P04  |                                |   |                          |          |                             |                      |   |  |      |              |               |     |
| GOODYEAR  |                                |   |                          |          |                             |                      |   |  |      |              |               |     |
| VIBRACOUSTIC<br>V 1 DF 26-2   |                                |   |                          |          |                             |                      |   |  |      |              |               |     |
| Code  | Manufacturer                   |   |                          |          |                             |                      |   |  |      |              |               |     |
| 81.43600.6040   | MAN                            |   |                          |          |                             |                      |   |  |      |              |               |     |



# Towing vehicle & Trailer & Semitrailer Air Springs

| Code  | Section, Top View, Bottom View | Applications                              |                                |  |                                   |  |   |      |              |          |          |                 |           |             |          |         |              |           |               |           |                 |
|---|--------------------------------|---|--------------------------------|--|-----------------------------------|--|---|------|--------------|----------|----------|-----------------|-----------|-------------|----------|---------|--------------|-----------|---------------|-----------|-----------------|
| <b>FM28001.C01</b>  |                                |   |                                |  |                                   |  |   |      |              |          |          |                 |           |             |          |         |              |           |               |           |                 |
| <table border="1"> <tr><td>Competitor code</td></tr> <tr><td>Firestone<br/>W01-358-6948</td></tr> <tr><td>ContiTech<br/>FD 200-25 429</td></tr> <tr><td>GOODYEAR<br/>2B9-251</td></tr> <tr><td>VIBRACOUSTIC</td></tr> </table>  | Competitor code                | Firestone<br>W01-358-6948                 | ContiTech<br>FD 200-25 429     | GOODYEAR<br>2B9-251                              | VIBRACOUSTIC                      |  | <table border="1"> <tr><td>Code</td><td>Manufacturer</td></tr> <tr><td>C-0080</td><td>Cush</td></tr> <tr><td>SC2123</td><td>Loadguard</td></tr> <tr><td>1003586948C</td><td>Ridewell</td></tr> <tr><td>AS-6948</td><td>Silent Drive</td></tr> <tr><td>AS-4429</td><td>Spring Valley</td></tr> <tr><td>AS-0122-G</td><td>Watson &amp; Chalin</td></tr> </table>      | Code | Manufacturer | C-0080   | Cush     | SC2123          | Loadguard | 1003586948C | Ridewell | AS-6948 | Silent Drive | AS-4429   | Spring Valley | AS-0122-G | Watson & Chalin |
| Competitor code   |                                |   |                                |  |                                   |  |   |      |              |          |          |                 |           |             |          |         |              |           |               |           |                 |
| Firestone<br>W01-358-6948   |                                |   |                                |  |                                   |  |   |      |              |          |          |                 |           |             |          |         |              |           |               |           |                 |
| ContiTech<br>FD 200-25 429  |                                |   |                                |  |                                   |  |   |      |              |          |          |                 |           |             |          |         |              |           |               |           |                 |
| GOODYEAR<br>2B9-251   |                                |   |                                |  |                                   |  |   |      |              |          |          |                 |           |             |          |         |              |           |               |           |                 |
| VIBRACOUSTIC  |                                |   |                                |  |                                   |  |   |      |              |          |          |                 |           |             |          |         |              |           |               |           |                 |
| Code  | Manufacturer                   |   |                                |  |                                   |  |   |      |              |          |          |                 |           |             |          |         |              |           |               |           |                 |
| C-0080  | Cush                           |   |                                |  |                                   |  |   |      |              |          |          |                 |           |             |          |         |              |           |               |           |                 |
| SC2123  | Loadguard                      |   |                                |  |                                   |  |   |      |              |          |          |                 |           |             |          |         |              |           |               |           |                 |
| 1003586948C   | Ridewell                       |   |                                |  |                                   |  |   |      |              |          |          |                 |           |             |          |         |              |           |               |           |                 |
| AS-6948   | Silent Drive                   |   |                                |  |                                   |  |   |      |              |          |          |                 |           |             |          |         |              |           |               |           |                 |
| AS-4429   | Spring Valley                  |   |                                |  |                                   |  |   |      |              |          |          |                 |           |             |          |         |              |           |               |           |                 |
| AS-0122-G   | Watson & Chalin                |   |                                |  |                                   |  |   |      |              |          |          |                 |           |             |          |         |              |           |               |           |                 |
| <b>FM28001.C02</b>  |                                |   |                                |  |                                   |  |   |      |              |          |          |                 |           |             |          |         |              |           |               |           |                 |
| <table border="1"> <tr><td>Competitor code</td></tr> <tr><td>Firestone<br/>W01-M58-6943</td></tr> <tr><td>ContiTech<br/>FD 200-25 426</td></tr> <tr><td>GOODYEAR<br/>2B9-250</td></tr> <tr><td>VIBRACOUSTIC</td></tr> </table>  | Competitor code                | Firestone<br>W01-M58-6943                 | ContiTech<br>FD 200-25 426     | GOODYEAR<br>2B9-250                              | VIBRACOUSTIC                      |  | <table border="1"> <tr><td>Code</td><td>Manufacturer</td></tr> <tr><td>6352</td><td>GRANNING</td></tr> <tr><td>SC2122</td><td>LOADGUARD</td></tr> <tr><td>90557237</td><td>SAF</td></tr> <tr><td>AS-4426</td><td>SPRINGVALEY</td></tr> <tr><td>AS-0041</td><td>WATSON&amp;CHALIN</td></tr> </table>   | Code | Manufacturer | 6352     | GRANNING | SC2122          | LOADGUARD | 90557237    | SAF      | AS-4426 | SPRINGVALEY  | AS-0041   | WATSON&CHALIN |           |                 |
| Competitor code   |                                |   |                                |  |                                   |  |   |      |              |          |          |                 |           |             |          |         |              |           |               |           |                 |
| Firestone<br>W01-M58-6943   |                                |   |                                |  |                                   |  |   |      |              |          |          |                 |           |             |          |         |              |           |               |           |                 |
| ContiTech<br>FD 200-25 426  |                                |   |                                |  |                                   |  |   |      |              |          |          |                 |           |             |          |         |              |           |               |           |                 |
| GOODYEAR<br>2B9-250   |                                |   |                                |  |                                   |  |   |      |              |          |          |                 |           |             |          |         |              |           |               |           |                 |
| VIBRACOUSTIC  |                                |   |                                |  |                                   |  |   |      |              |          |          |                 |           |             |          |         |              |           |               |           |                 |
| Code  | Manufacturer                   |   |                                |  |                                   |  |   |      |              |          |          |                 |           |             |          |         |              |           |               |           |                 |
| 6352  | GRANNING                       |   |                                |  |                                   |  |   |      |              |          |          |                 |           |             |          |         |              |           |               |           |                 |
| SC2122  | LOADGUARD                      |   |                                |  |                                   |  |   |      |              |          |          |                 |           |             |          |         |              |           |               |           |                 |
| 90557237  | SAF                            |   |                                |  |                                   |  |   |      |              |          |          |                 |           |             |          |         |              |           |               |           |                 |
| AS-4426   | SPRINGVALEY                    |   |                                |  |                                   |  |   |      |              |          |          |                 |           |             |          |         |              |           |               |           |                 |
| AS-0041   | WATSON&CHALIN                  |   |                                |  |                                   |  |   |      |              |          |          |                 |           |             |          |         |              |           |               |           |                 |
| <b>FM28001.C03</b>  |                                |   |                                |  |                                   |  |   |      |              |          |          |                 |           |             |          |         |              |           |               |           |                 |
| <table border="1"> <tr><td>Competitor code</td></tr> <tr><td>Firestone<br/>W01-M58-7679<br/>W01-968-6771</td></tr> <tr><td>ContiTech<br/>FD 200-25 1/4 M10</td></tr> <tr><td>GOODYEAR<br/>2B9-269</td></tr> <tr><td>VIBRACOUSTIC<br/>V SP 2 B 12 RA-10</td></tr> </table> | Competitor code                | Firestone<br>W01-M58-7679<br>W01-968-6771 | ContiTech<br>FD 200-25 1/4 M10 | GOODYEAR<br>2B9-269                              | VIBRACOUSTIC<br>V SP 2 B 12 RA-10 |  | <table border="1"> <tr><td>Code</td><td>Manufacturer</td></tr> <tr><td>15670</td><td>GRANNING</td></tr> <tr><td>A 946 328 21 01</td><td>MERCEDES</td></tr> <tr><td>21221356</td><td>MERITOR</td></tr> <tr><td>16 808</td><td>SCHMITZ</td></tr> <tr><td>US 07394F</td><td rowspan="3">WEWELER</td></tr> <tr><td>US 07394</td></tr> <tr><td>AC 173</td></tr> </table> | Code | Manufacturer | 15670    | GRANNING | A 946 328 21 01 | MERCEDES  | 21221356    | MERITOR  | 16 808  | SCHMITZ      | US 07394F | WEWELER       | US 07394  | AC 173          |
| Competitor code   |                                |   |                                |  |                                   |  |   |      |              |          |          |                 |           |             |          |         |              |           |               |           |                 |
| Firestone<br>W01-M58-7679<br>W01-968-6771   |                                |   |                                |  |                                   |  |   |      |              |          |          |                 |           |             |          |         |              |           |               |           |                 |
| ContiTech<br>FD 200-25 1/4 M10  |                                |   |                                |  |                                   |  |   |      |              |          |          |                 |           |             |          |         |              |           |               |           |                 |
| GOODYEAR<br>2B9-269   |                                |   |                                |  |                                   |  |   |      |              |          |          |                 |           |             |          |         |              |           |               |           |                 |
| VIBRACOUSTIC<br>V SP 2 B 12 RA-10   |                                |   |                                |  |                                   |  |   |      |              |          |          |                 |           |             |          |         |              |           |               |           |                 |
| Code  | Manufacturer                   |   |                                |  |                                   |  |   |      |              |          |          |                 |           |             |          |         |              |           |               |           |                 |
| 15670   | GRANNING                       |   |                                |  |                                   |  |   |      |              |          |          |                 |           |             |          |         |              |           |               |           |                 |
| A 946 328 21 01   | MERCEDES                       |   |                                |  |                                   |  |   |      |              |          |          |                 |           |             |          |         |              |           |               |           |                 |
| 21221356  | MERITOR                        |   |                                |  |                                   |  |   |      |              |          |          |                 |           |             |          |         |              |           |               |           |                 |
| 16 808  | SCHMITZ                        |   |                                |  |                                   |  |   |      |              |          |          |                 |           |             |          |         |              |           |               |           |                 |
| US 07394F   | WEWELER                        |   |                                |  |                                   |  |   |      |              |          |          |                 |           |             |          |         |              |           |               |           |                 |
| US 07394  |                                |   |                                |  |                                   |  |   |      |              |          |          |                 |           |             |          |         |              |           |               |           |                 |
| AC 173  |                                |   |                                |  |                                   |  |   |      |              |          |          |                 |           |             |          |         |              |           |               |           |                 |
| <b>FM28001.C04</b>  |                                |   |                                |  |                                   |  |   |      |              |          |          |                 |           |             |          |         |              |           |               |           |                 |
| <table border="1"> <tr><td>Competitor code</td></tr> <tr><td>Firestone</td></tr> <tr><td>ContiTech<br/>FD 200-25 M24 M10</td></tr> <tr><td>GOODYEAR<br/>2B9-703; 2B9-741<br/>2B9-605; 2B9-743</td></tr> <tr><td>VIBRACOUSTIC</td></tr> </table>                           | Competitor code                | Firestone                                 | ContiTech<br>FD 200-25 M24 M10 | GOODYEAR<br>2B9-703; 2B9-741<br>2B9-605; 2B9-743 | VIBRACOUSTIC                      |  | <table border="1"> <tr><td>Code</td><td>Manufacturer</td></tr> <tr><td>22573233</td><td rowspan="2">VOLVO</td></tr> <tr><td>20541504</td></tr> </table>   | Code | Manufacturer | 22573233 | VOLVO    | 20541504        |           |             |          |         |              |           |               |           |                 |
| Competitor code   |                                |   |                                |  |                                   |  |   |      |              |          |          |                 |           |             |          |         |              |           |               |           |                 |
| Firestone   |                                |   |                                |  |                                   |  |   |      |              |          |          |                 |           |             |          |         |              |           |               |           |                 |
| ContiTech<br>FD 200-25 M24 M10  |                                |   |                                |  |                                   |  |   |      |              |          |          |                 |           |             |          |         |              |           |               |           |                 |
| GOODYEAR<br>2B9-703; 2B9-741<br>2B9-605; 2B9-743  |                                |   |                                |  |                                   |  |   |      |              |          |          |                 |           |             |          |         |              |           |               |           |                 |
| VIBRACOUSTIC  |                                |   |                                |  |                                   |  |   |      |              |          |          |                 |           |             |          |         |              |           |               |           |                 |
| Code  | Manufacturer                   |   |                                |  |                                   |  |   |      |              |          |          |                 |           |             |          |         |              |           |               |           |                 |
| 22573233  | VOLVO                          |   |                                |  |                                   |  |   |      |              |          |          |                 |           |             |          |         |              |           |               |           |                 |
| 20541504  |                                |   |                                |  |                                   |  |   |      |              |          |          |                 |           |             |          |         |              |           |               |           |                 |



# Towing vehicle & Trailer & Semitrailer Air Springs

| Code  | Section, Top View, Bottom View | Applications              |                            |                          |                                  |   |   |      |              |              |               |          |               |            |                 |               |
|---|--------------------------------|---------------------------|----------------------------|--------------------------|----------------------------------|---|---|------|--------------|--------------|---------------|----------|---------------|------------|-----------------|---------------|
| <b>FM28001.C05</b>  |                                |                           |                            |                          |                                  |   |   |      |              |              |               |          |               |            |                 |               |
| <table border="1"> <tr><td>Competitor code</td></tr> <tr><td>Firestone</td></tr> <tr><td>ContiTech<br/>FD 200-25 P02</td></tr> <tr><td>GOODYEAR<br/>578-92-3-206</td></tr> <tr><td>VIBRACOUSTIC<br/>V SP 2 B 12 RA-3</td></tr> </table> | Competitor code                | Firestone                 | ContiTech<br>FD 200-25 P02 | GOODYEAR<br>578-92-3-206 | VIBRACOUSTIC<br>V SP 2 B 12 RA-3 |   | <table border="1"> <tr> <th>Code</th> <th>Manufacturer</th> </tr> <tr> <td>4.229.1005.00</td> <td rowspan="2">SAF</td> </tr> <tr> <td>4.229.1005.01</td> </tr> </table>   |      | Code         | Manufacturer | 4.229.1005.00 | SAF      | 4.229.1005.01 |            |                 |               |
| Competitor code   |                                |                           |                            |                          |                                  |   |   |      |              |              |               |          |               |            |                 |               |
| Firestone   |                                |                           |                            |                          |                                  |   |   |      |              |              |               |          |               |            |                 |               |
| ContiTech<br>FD 200-25 P02  |                                |                           |                            |                          |                                  |   |   |      |              |              |               |          |               |            |                 |               |
| GOODYEAR<br>578-92-3-206  |                                |                           |                            |                          |                                  |   |   |      |              |              |               |          |               |            |                 |               |
| VIBRACOUSTIC<br>V SP 2 B 12 RA-3  |                                |                           |                            |                          |                                  |   |   |      |              |              |               |          |               |            |                 |               |
| Code  | Manufacturer                   |                           |                            |                          |                                  |   |   |      |              |              |               |          |               |            |                 |               |
| 4.229.1005.00   | SAF                            |                           |                            |                          |                                  |   |   |      |              |              |               |          |               |            |                 |               |
| 4.229.1005.01   |                                |                           |                            |                          |                                  |   |   |      |              |              |               |          |               |            |                 |               |
| <b>FM28001.C06</b>  |                                |                           |                            |                          |                                  |   |   |      |              |              |               |          |               |            |                 |               |
| <table border="1"> <tr><td>Competitor code</td></tr> <tr><td>Firestone<br/>W01-M58-6945</td></tr> <tr><td>ContiTech<br/>FD 200-25 427</td></tr> <tr><td>GOODYEAR<br/>2B9-253</td></tr> <tr><td>VIBRACOUSTIC</td></tr> </table>          | Competitor code                | Firestone<br>W01-M58-6945 | ContiTech<br>FD 200-25 427 | GOODYEAR<br>2B9-253      | VIBRACOUSTIC                     |   | <table border="1"> <tr> <th>Code</th> <th>Manufacturer</th> </tr> <tr> <td>1003586945C</td> <td>Ridewell</td> </tr> <tr> <td>SC2125</td> <td>Leyland</td> </tr> <tr> <td>AS0119F</td> <td>WATSON&amp;CHALIN</td> </tr> </table> |      | Code         | Manufacturer | 1003586945C   | Ridewell | SC2125        | Leyland    | AS0119F         | WATSON&CHALIN |
| Competitor code   |                                |                           |                            |                          |                                  |   |   |      |              |              |               |          |               |            |                 |               |
| Firestone<br>W01-M58-6945   |                                |                           |                            |                          |                                  |   |   |      |              |              |               |          |               |            |                 |               |
| ContiTech<br>FD 200-25 427  |                                |                           |                            |                          |                                  |   |   |      |              |              |               |          |               |            |                 |               |
| GOODYEAR<br>2B9-253   |                                |                           |                            |                          |                                  |   |   |      |              |              |               |          |               |            |                 |               |
| VIBRACOUSTIC  |                                |                           |                            |                          |                                  |   |   |      |              |              |               |          |               |            |                 |               |
| Code  | Manufacturer                   |                           |                            |                          |                                  |   |   |      |              |              |               |          |               |            |                 |               |
| 1003586945C   | Ridewell                       |                           |                            |                          |                                  |   |   |      |              |              |               |          |               |            |                 |               |
| SC2125  | Leyland                        |                           |                            |                          |                                  |   |   |      |              |              |               |          |               |            |                 |               |
| AS0119F   | WATSON&CHALIN                  |                           |                            |                          |                                  |   |   |      |              |              |               |          |               |            |                 |               |
| <b>FM28002.C01</b>  |                                |                           |                            |                          |                                  |   |   |      |              |              |               |          |               |            |                 |               |
| <table border="1"> <tr><td>Competitor code</td></tr> <tr><td>Firestone<br/>W01-358-7557</td></tr> <tr><td>ContiTech<br/>FD 530-35 530</td></tr> <tr><td>GOODYEAR<br/>2B 14383</td></tr> </table>  | Competitor code                | Firestone<br>W01-358-7557 | ContiTech<br>FD 530-35 530 | GOODYEAR<br>2B 14383     |                                  | <table border="1"> <tr> <th>Code</th> <th>Manufacturer</th> </tr> <tr> <td>10316</td> <td>Histeer</td> </tr> <tr> <td>19983-01</td> <td>Reyco</td> </tr> <tr> <td>AS-0089-1G</td> <td>Watson &amp; Chalin</td> </tr> </table> |   | Code | Manufacturer | 10316        | Histeer       | 19983-01 | Reyco         | AS-0089-1G | Watson & Chalin |               |
| Competitor code   |                                |                           |                            |                          |                                  |   |   |      |              |              |               |          |               |            |                 |               |
| Firestone<br>W01-358-7557   |                                |                           |                            |                          |                                  |   |   |      |              |              |               |          |               |            |                 |               |
| ContiTech<br>FD 530-35 530  |                                |                           |                            |                          |                                  |   |   |      |              |              |               |          |               |            |                 |               |
| GOODYEAR<br>2B 14383  |                                |                           |                            |                          |                                  |   |   |      |              |              |               |          |               |            |                 |               |
| Code  | Manufacturer                   |                           |                            |                          |                                  |   |   |      |              |              |               |          |               |            |                 |               |
| 10316   | Histeer                        |                           |                            |                          |                                  |   |   |      |              |              |               |          |               |            |                 |               |
| 19983-01  | Reyco                          |                           |                            |                          |                                  |   |   |      |              |              |               |          |               |            |                 |               |
| AS-0089-1G  | Watson & Chalin                |                           |                            |                          |                                  |   |   |      |              |              |               |          |               |            |                 |               |

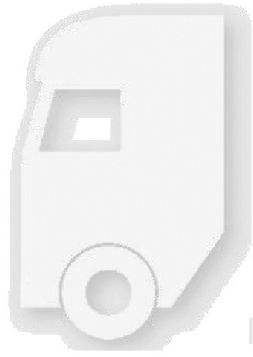

# **Driver's Cab & Seat Air Springs**









| Code               | Section, Top View, Bottom View | Applications   |      |              |                    |         |  |      |              |                    |         |
|--------------------|--------------------------------|--|------|--------------|--------------------|---------|--|------|--------------|--------------------|---------|
| FM98003.C01        |                                | <table border="1"> <tr> <th>Code</th> <th>Manufacturer</th> </tr> <tr> <td>5001025A1063-C00/C</td> <td>FAW</td> </tr> </table> | Code | Manufacturer | 5001025A1063-C00/C | FAW     | <table border="1"> <tr> <th>Code</th> <th>Manufacturer</th> </tr> <tr> <td>5001025A1063-C00/C</td> <td>FAW</td> </tr> </table> | Code | Manufacturer | 5001025A1063-C00/C | FAW     |
| Code               | Manufacturer                   |  |      |              |                    |         |  |      |              |                    |         |
| 5001025A1063-C00/C | FAW                            |  |      |              |                    |         |  |      |              |                    |         |
| Code               | Manufacturer                   |  |      |              |                    |         |  |      |              |                    |         |
| 5001025A1063-C00/C | FAW                            |  |      |              |                    |         |  |      |              |                    |         |
| FM98003.C02        |                                | <table border="1"> <tr> <th>Code</th> <th>Manufacturer</th> </tr> <tr> <td>5001315A1063-C00</td> <td>FAW</td> </tr> </table>   | Code | Manufacturer | 5001315A1063-C00   | FAW     | <table border="1"> <tr> <th>Code</th> <th>Manufacturer</th> </tr> <tr> <td>5001315A1063-C00</td> <td>FAW</td> </tr> </table>   | Code | Manufacturer | 5001315A1063-C00   | FAW     |
| Code               | Manufacturer                   |  |      |              |                    |         |  |      |              |                    |         |
| 5001315A1063-C00   | FAW                            |  |      |              |                    |         |  |      |              |                    |         |
| Code               | Manufacturer                   |  |      |              |                    |         |  |      |              |                    |         |
| 5001315A1063-C00   | FAW                            |  |      |              |                    |         |  |      |              |                    |         |
| FM98004.C01        |                                | <table border="1"> <tr> <th>Code</th> <th>Manufacturer</th> </tr> <tr> <td>D214251430020</td> <td>SHACMAN</td> </tr> </table>  | Code | Manufacturer | D214251430020      | SHACMAN | <table border="1"> <tr> <th>Code</th> <th>Manufacturer</th> </tr> <tr> <td>D214251430020</td> <td>SHACMAN</td> </tr> </table>  | Code | Manufacturer | D214251430020      | SHACMAN |
| Code               | Manufacturer                   |  |      |              |                    |         |  |      |              |                    |         |
| D214251430020      | SHACMAN                        |  |      |              |                    |         |  |      |              |                    |         |
| Code               | Manufacturer                   |  |      |              |                    |         |  |      |              |                    |         |
| D214251430020      | SHACMAN                        |  |      |              |                    |         |  |      |              |                    |         |
| FM98004.C02        |                                | <table border="1"> <tr> <th>Code</th> <th>Manufacturer</th> </tr> <tr> <td>D214251440020</td> <td>SHACMAN</td> </tr> </table>  | Code | Manufacturer | D214251440020      | SHACMAN | <table border="1"> <tr> <th>Code</th> <th>Manufacturer</th> </tr> <tr> <td>D214251440020</td> <td>SHACMAN</td> </tr> </table>  | Code | Manufacturer | D214251440020      | SHACMAN |
| Code               | Manufacturer                   |  |      |              |                    |         |  |      |              |                    |         |
| D214251440020      | SHACMAN                        |  |      |              |                    |         |  |      |              |                    |         |
| Code               | Manufacturer                   |  |      |              |                    |         |  |      |              |                    |         |
| D214251440020      | SHACMAN                        |  |      |              |                    |         |  |      |              |                    |         |
| FM98005.C01        |                                | <table border="1"> <tr> <th>Code</th> <th>Manufacturer</th> </tr> <tr> <td>DZ15221440400</td> <td>SHACMAN</td> </tr> </table>  | Code | Manufacturer | DZ15221440400      | SHACMAN | <table border="1"> <tr> <th>Code</th> <th>Manufacturer</th> </tr> <tr> <td>DZ15221440400</td> <td>SHACMAN</td> </tr> </table>  | Code | Manufacturer | DZ15221440400      | SHACMAN |
| Code               | Manufacturer                   |  |      |              |                    |         |  |      |              |                    |         |
| DZ15221440400      | SHACMAN                        |  |      |              |                    |         |  |      |              |                    |         |
| Code               | Manufacturer                   |  |      |              |                    |         |  |      |              |                    |         |
| DZ15221440400      | SHACMAN                        |  |      |              |                    |         |  |      |              |                    |         |
| FM98005.C02        |                                | <table border="1"> <tr> <th>Code</th> <th>Manufacturer</th> </tr> <tr> <td>DZ15221440800</td> <td>SHACMAN</td> </tr> </table>  | Code | Manufacturer | DZ15221440800      | SHACMAN | <table border="1"> <tr> <th>Code</th> <th>Manufacturer</th> </tr> <tr> <td>DZ15221440800</td> <td>SHACMAN</td> </tr> </table>  | Code | Manufacturer | DZ15221440800      | SHACMAN |
| Code               | Manufacturer                   |  |      |              |                    |         |  |      |              |                    |         |
| DZ15221440800      | SHACMAN                        |  |      |              |                    |         |  |      |              |                    |         |
| Code               | Manufacturer                   |  |      |              |                    |         |  |      |              |                    |         |
| DZ15221440800      | SHACMAN                        |  |      |              |                    |         |  |      |              |                    |         |



| Code                      | Section, Top View, Bottom View | Applications  |  |      |              |               |             |               |  |
|---------------------------|--------------------------------|---|--|------|--------------|---------------|-------------|---------------|--|
| <b>FM98006.C01</b><br>NEW |                                | <table border="1"> <thead> <tr> <th>Code</th> <th>Manufacturer</th> </tr> </thead> <tbody> <tr> <td>H4502B01015A0</td> <td>FOTON AUMAN</td> </tr> <tr> <td>H4503050201A0</td> <td></td> </tr> </tbody> </table> |  | Code | Manufacturer | H4502B01015A0 | FOTON AUMAN | H4503050201A0 |  |
| Code                      | Manufacturer                   |   |  |      |              |               |             |               |  |
| H4502B01015A0             | FOTON AUMAN                    |   |  |      |              |               |             |               |  |
| H4503050201A0             |                                |   |  |      |              |               |             |               |  |
| <b>FM98006.C02</b><br>NEW |                                | <table border="1"> <thead> <tr> <th>Code</th> <th>Manufacturer</th> </tr> </thead> <tbody> <tr> <td>H4502A01030A0</td> <td>FOTON AUMAN</td> </tr> <tr> <td>H4502040202A0</td> <td></td> </tr> </tbody> </table> |  | Code | Manufacturer | H4502A01030A0 | FOTON AUMAN | H4502040202A0 |  |
| Code                      | Manufacturer                   |   |  |      |              |               |             |               |  |
| H4502A01030A0             | FOTON AUMAN                    |   |  |      |              |               |             |               |  |
| H4502040202A0             |                                |   |  |      |              |               |             |               |  |
| <b>FM98007.C01</b>        |                                | <table border="1"> <thead> <tr> <th>Code</th> <th>Manufacturer</th> </tr> </thead> <tbody> <tr> <td>5001025-E18</td> <td>FAW</td> </tr> </tbody> </table>   |  | Code | Manufacturer | 5001025-E18   | FAW         |               |  |
| Code                      | Manufacturer                   |   |  |      |              |               |             |               |  |
| 5001025-E18               | FAW                            |   |  |      |              |               |             |               |  |
| <b>FM98007.C02</b>        |                                | <table border="1"> <thead> <tr> <th>Code</th> <th>Manufacturer</th> </tr> </thead> <tbody> <tr> <td>5001315-E18</td> <td>FAW</td> </tr> </tbody> </table>   |  | Code | Manufacturer | 5001315-E18   | FAW         |               |  |
| Code                      | Manufacturer                   |   |  |      |              |               |             |               |  |
| 5001315-E18               | FAW                            |   |  |      |              |               |             |               |  |
| <b>FM98008.C01</b>        |                                | <table border="1"> <thead> <tr> <th>Code</th> <th>Manufacturer</th> </tr> </thead> <tbody> <tr> <td>H4502A01030A0</td> <td></td> </tr> </tbody> </table>  |  | Code | Manufacturer | H4502A01030A0 |             |               |  |
| Code                      | Manufacturer                   |   |  |      |              |               |             |               |  |
| H4502A01030A0             |                                |   |  |      |              |               |             |               |  |
| <b>FM98008.C02</b>        |                                | <table border="1"> <thead> <tr> <th>Code</th> <th>Manufacturer</th> </tr> </thead> <tbody> <tr> <td>H4502A01015A0</td> <td></td> </tr> </tbody> </table>  |  | Code | Manufacturer | H4502A01015A0 |             |               |  |
| Code                      | Manufacturer                   |   |  |      |              |               |             |               |  |
| H4502A01015A0             |                                |   |  |      |              |               |             |               |  |

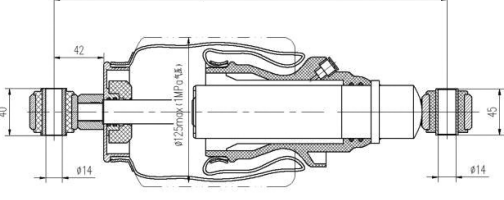
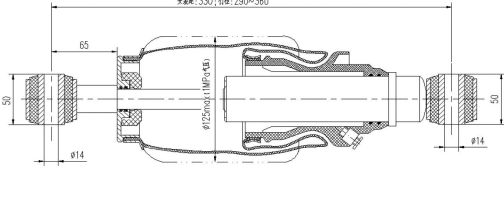
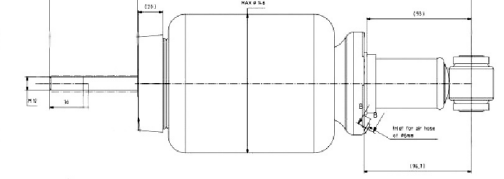

# Driver's Cab & Seat Air Springs

| Code              | Section, Top View, Bottom View  | Applications   |      |              |                   |  |   |      |              |  |  |
|-------------------|---|--|------|--------------|-------------------|--|---|------|--------------|--|--|
| FM98009C01        |    | <table border="1"> <tr> <th>Code</th> <th>Manufacturer</th> </tr> <tr> <td>712W41722-6022</td> <td></td> </tr> </table>    | Code | Manufacturer | 712W41722-6022    |  | <table border="1"> <tr> <th>Code</th> <th>Manufacturer</th> </tr> <tr> <td></td> <td></td> </tr> </table> | Code | Manufacturer |  |  |
| Code              | Manufacturer  |  |      |              |                   |  |   |      |              |  |  |
| 712W41722-6022    |   |  |      |              |                   |  |   |      |              |  |  |
| Code              | Manufacturer  |  |      |              |                   |  |   |      |              |  |  |
|                   |   |  |      |              |                   |  |   |      |              |  |  |
| FM98009.C02       |    | <table border="1"> <tr> <th>Code</th> <th>Manufacturer</th> </tr> <tr> <td>712W41722-6032</td> <td></td> </tr> </table>    | Code | Manufacturer | 712W41722-6032    |  | <table border="1"> <tr> <th>Code</th> <th>Manufacturer</th> </tr> <tr> <td></td> <td></td> </tr> </table> | Code | Manufacturer |  |  |
| Code              | Manufacturer  |  |      |              |                   |  |   |      |              |  |  |
| 712W41722-6032    |   |  |      |              |                   |  |   |      |              |  |  |
| Code              | Manufacturer  |  |      |              |                   |  |   |      |              |  |  |
|                   |   |  |      |              |                   |  |   |      |              |  |  |
| FM98010.C01       |   | <table border="1"> <tr> <th>Code</th> <th>Manufacturer</th> </tr> <tr> <td>5001025B91W-C00/E</td> <td></td> </tr> </table> | Code | Manufacturer | 5001025B91W-C00/E |  | <table border="1"> <tr> <th>Code</th> <th>Manufacturer</th> </tr> <tr> <td></td> <td></td> </tr> </table> | Code | Manufacturer |  |  |
| Code              | Manufacturer  |  |      |              |                   |  |   |      |              |  |  |
| 5001025B91W-C00/E |   |  |      |              |                   |  |   |      |              |  |  |
| Code              | Manufacturer  |  |      |              |                   |  |   |      |              |  |  |
|                   |   |  |      |              |                   |  |   |      |              |  |  |
| FM98010.C02       |  | <table border="1"> <tr> <th>Code</th> <th>Manufacturer</th> </tr> <tr> <td>5001325B91W-C00/C</td> <td></td> </tr> </table> | Code | Manufacturer | 5001325B91W-C00/C |  | <table border="1"> <tr> <th>Code</th> <th>Manufacturer</th> </tr> <tr> <td></td> <td></td> </tr> </table> | Code | Manufacturer |  |  |
| Code              | Manufacturer  |  |      |              |                   |  |   |      |              |  |  |
| 5001325B91W-C00/C |   |  |      |              |                   |  |   |      |              |  |  |
| Code              | Manufacturer  |  |      |              |                   |  |   |      |              |  |  |
|                   |   |  |      |              |                   |  |   |      |              |  |  |
| FM98011.C01       |  | <table border="1"> <tr> <th>Code</th> <th>Manufacturer</th> </tr> <tr> <td>H73-5001450C</td> <td></td> </tr> </table>      | Code | Manufacturer | H73-5001450C      |  | <table border="1"> <tr> <th>Code</th> <th>Manufacturer</th> </tr> <tr> <td></td> <td></td> </tr> </table> | Code | Manufacturer |  |  |
| Code              | Manufacturer  |  |      |              |                   |  |   |      |              |  |  |
| H73-5001450C      |   |  |      |              |                   |  |   |      |              |  |  |
| Code              | Manufacturer  |  |      |              |                   |  |   |      |              |  |  |
|                   |   |  |      |              |                   |  |   |      |              |  |  |
| FM98011.C02       |  | <table border="1"> <tr> <th>Code</th> <th>Manufacturer</th> </tr> <tr> <td>M7Q-5001550C</td> <td></td> </tr> </table>      | Code | Manufacturer | M7Q-5001550C      |  | <table border="1"> <tr> <th>Code</th> <th>Manufacturer</th> </tr> <tr> <td></td> <td></td> </tr> </table> | Code | Manufacturer |  |  |
| Code              | Manufacturer  |  |      |              |                   |  |   |      |              |  |  |
| M7Q-5001550C      |   |  |      |              |                   |  |   |      |              |  |  |
| Code              | Manufacturer  |  |      |              |                   |  |   |      |              |  |  |
|                   |   |  |      |              |                   |  |   |      |              |  |  |
| FM98012.C01       |  | <table border="1"> <tr> <th>Code</th> <th>Manufacturer</th> </tr> <tr> <td>3256142</td> <td></td> </tr> </table>           | Code | Manufacturer | 3256142           |  | <table border="1"> <tr> <th>Code</th> <th>Manufacturer</th> </tr> <tr> <td></td> <td></td> </tr> </table> | Code | Manufacturer |  |  |
| Code              | Manufacturer  |  |      |              |                   |  |   |      |              |  |  |
| 3256142           |   |  |      |              |                   |  |   |      |              |  |  |
| Code              | Manufacturer  |  |      |              |                   |  |   |      |              |  |  |
|                   |   |  |      |              |                   |  |   |      |              |  |  |



# Driver's Cab & Seat Air Springs



| Code  | Section, Top View, Bottom View | Applications  |                        |       |              |           |     |            |           |     |            |           |     |          |           |  |          |           |  |          |           |  |          |            |  |     |
|---|--------------------------------|---|------------------------|-------|--------------|-----------|-----|------------|-----------|-----|------------|-----------|-----|----------|-----------|--|----------|-----------|--|----------|-----------|--|----------|------------|--|-----|
| <b>FM98012.C02</b>  |                                |   |                        |       |              |           |     |            |           |     |            |           |     |          |           |  |          |           |  |          |           |  |          |            |  |     |
|   |                                | <table border="1"> <thead> <tr> <th data-bbox="1035 418 1204 452">Code</th> <th data-bbox="1208 418 1441 452">Manufacturer</th> </tr> </thead> <tbody> <tr> <td data-bbox="1035 457 1204 491">3256120</td> <td data-bbox="1208 457 1441 491"></td> </tr> </tbody> </table>  |                        | Code  | Manufacturer | 3256120   |     |            |           |     |            |           |     |          |           |  |          |           |  |          |           |  |          |            |  |     |
| Code  | Manufacturer                   |   |                        |       |              |           |     |            |           |     |            |           |     |          |           |  |          |           |  |          |           |  |          |            |  |     |
| 3256120   |                                |   |                        |       |              |           |     |            |           |     |            |           |     |          |           |  |          |           |  |          |           |  |          |            |  |     |
| <b>FM98001.C01</b>  |                                |   |                        |       |              |           |     |            |           |     |            |           |     |          |           |  |          |           |  |          |           |  |          |            |  |     |
| <table border="1"> <tr> <td data-bbox="169 745 413 808">Competitor code</td> </tr> <tr> <td data-bbox="169 812 413 875">Firestone</td> </tr> <tr> <td data-bbox="169 879 413 942">ContiTech<br/>SZ 75-138</td> </tr> </table>     | Competitor code                | Firestone   | ContiTech<br>SZ 75-138 |       |              |           |     |            |           |     |            |           |     |          |           |  |          |           |  |          |           |  |          |            |  |     |
| Competitor code   |                                |   |                        |       |              |           |     |            |           |     |            |           |     |          |           |  |          |           |  |          |           |  |          |            |  |     |
| Firestone   |                                |   |                        |       |              |           |     |            |           |     |            |           |     |          |           |  |          |           |  |          |           |  |          |            |  |     |
| ContiTech<br>SZ 75-138  |                                |   |                        |       |              |           |     |            |           |     |            |           |     |          |           |  |          |           |  |          |           |  |          |            |  |     |
| <b>FM98002.C01</b>  |                                |   |                        |       |              |           |     |            |           |     |            |           |     |          |           |  |          |           |  |          |           |  |          |            |  |     |
| <table border="1"> <tr> <td data-bbox="169 1198 413 1261">Competitor code</td> </tr> <tr> <td data-bbox="169 1265 413 1328">Firestone</td> </tr> <tr> <td data-bbox="169 1332 413 1394">ContiTech<br/>SZ 51-7</td> </tr> </table> | Competitor code                | Firestone   | ContiTech<br>SZ 51-7   |       |              |           |     |            |           |     |            |           |     |          |           |  |          |           |  |          |           |  |          |            |  |     |
| Competitor code   |                                |   |                        |       |              |           |     |            |           |     |            |           |     |          |           |  |          |           |  |          |           |  |          |            |  |     |
| Firestone   |                                |   |                        |       |              |           |     |            |           |     |            |           |     |          |           |  |          |           |  |          |           |  |          |            |  |     |
| ContiTech<br>SZ 51-7  |                                |   |                        |       |              |           |     |            |           |     |            |           |     |          |           |  |          |           |  |          |           |  |          |            |  |     |
| <b>FM28001.C04</b>  |                                |   |                        |       |              |           |     |            |           |     |            |           |     |          |           |  |          |           |  |          |           |  |          |            |  |     |
| <p>Air suspension for seats, cabs and passenger cars</p> <p>Customised development according to customer samples and drawings.</p>  |                                | <table border="1"> <tbody> <tr> <td data-bbox="786 1651 874 1819" rowspan="3">taper</td> <td data-bbox="877 1651 1058 1690"><math>\phi 133</math></td> <td data-bbox="1061 1651 1241 1690"><math>\phi 89</math></td> <td data-bbox="1244 1651 1425 1690">206</td> </tr> <tr> <td data-bbox="877 1694 1058 1733"><math>\phi 120</math></td> <td data-bbox="1061 1694 1241 1733"><math>\phi 81</math></td> <td data-bbox="1244 1694 1425 1733">225</td> </tr> <tr> <td data-bbox="877 1737 1058 1776"><math>\phi 142</math></td> <td data-bbox="1061 1737 1241 1776"><math>\phi 95</math></td> <td data-bbox="1244 1737 1425 1776">270</td> </tr> <tr> <td data-bbox="786 1823 874 1987" rowspan="4">straight</td> <td data-bbox="877 1823 1058 1862"><math>\phi 75</math></td> <td data-bbox="1061 1823 1241 1862"></td> <td data-bbox="1244 1823 1425 1862">Max(320)</td> </tr> <tr> <td data-bbox="877 1867 1058 1905"><math>\phi 72</math></td> <td data-bbox="1061 1867 1241 1905"></td> <td data-bbox="1244 1867 1425 1905">Max(345)</td> </tr> <tr> <td data-bbox="877 1910 1058 1949"><math>\phi 91</math></td> <td data-bbox="1061 1910 1241 1949"></td> <td data-bbox="1244 1910 1425 1949">Max(320)</td> </tr> <tr> <td data-bbox="877 1953 1058 1992"><math>\phi 128</math></td> <td data-bbox="1061 1953 1241 1992"></td> <td data-bbox="1244 1953 1425 1992">350</td> </tr> </tbody> </table> |                        | taper | $\phi 133$   | $\phi 89$ | 206 | $\phi 120$ | $\phi 81$ | 225 | $\phi 142$ | $\phi 95$ | 270 | straight | $\phi 75$ |  | Max(320) | $\phi 72$ |  | Max(345) | $\phi 91$ |  | Max(320) | $\phi 128$ |  | 350 |
| taper   | $\phi 133$                     | $\phi 89$   | 206                    |       |              |           |     |            |           |     |            |           |     |          |           |  |          |           |  |          |           |  |          |            |  |     |
|   | $\phi 120$                     | $\phi 81$   | 225                    |       |              |           |     |            |           |     |            |           |     |          |           |  |          |           |  |          |           |  |          |            |  |     |
|   | $\phi 142$                     | $\phi 95$   | 270                    |       |              |           |     |            |           |     |            |           |     |          |           |  |          |           |  |          |           |  |          |            |  |     |
| straight  | $\phi 75$                      |   | Max(320)               |       |              |           |     |            |           |     |            |           |     |          |           |  |          |           |  |          |           |  |          |            |  |     |
|   | $\phi 72$                      |   | Max(345)               |       |              |           |     |            |           |     |            |           |     |          |           |  |          |           |  |          |           |  |          |            |  |     |
|   | $\phi 91$                      |   | Max(320)               |       |              |           |     |            |           |     |            |           |     |          |           |  |          |           |  |          |           |  |          |            |  |     |
|   | $\phi 128$                     |   | 350                    |       |              |           |     |            |           |     |            |           |     |          |           |  |          |           |  |          |           |  |          |            |  |     |





**Problems, causes  
and solutions**



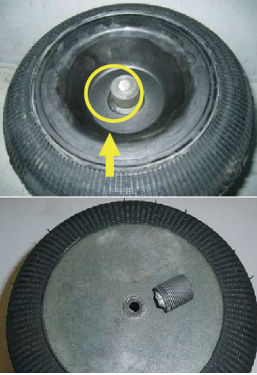

| <b>PROBLEM PICTURES</b>   | <b>PROBLEM &amp; CAUSE</b>   | <b>SOLUTION</b>   |
|---|--|---|
|    | <b>Deformed BEAD</b> <ul style="list-style-type: none"><li>• improper storage</li><li>• improper transport / improper handling</li></ul>                                       | <ul style="list-style-type: none"><li>• storage according to ISO 2230 : 2002 no daylight, dry, at normal room temperature</li><li>• avoid improper transport /improper handling</li></ul> |
|   | <b>Damage of the conical beads and cuts</b> <ul style="list-style-type: none"><li>• improperly mounted bead plate</li><li>• pinching of the bellows with metal parts</li></ul> | <ul style="list-style-type: none"><li>• keep conical beads clean and corrosion free</li><li>• avoid driving without pressure in the air suspension</li></ul>                              |
|  | <b>Bellows rubs off at shoulder</b> <ul style="list-style-type: none"><li>• bead plate diameter incorrect</li><li>• bellows too long for application</li></ul>                 | <ul style="list-style-type: none"><li>• make sure to use original parts</li><li>• avoid wrong cross references</li></ul>  |
|  | <b>Broken off thread bolts</b> <ul style="list-style-type: none"><li>• excessive torque</li><li>• use of oils or lubricants</li></ul>  | <ul style="list-style-type: none"><li>• don't exceed recommended torque according to your maintenance manual</li><li>• avoid usage of oils or lubricants</li></ul>                        |



| PROBLEM PICTURES  | PROBLEM & CAUSE   | SOLUTION   |
|---|---|--|
|    | <p><b>Overextension</b></p> <ul style="list-style-type: none"><li>• spring travel not restricted</li><li>• incorrectly adjusted level control</li><li>• air spring not suitable for application</li></ul> | <ul style="list-style-type: none"><li>• check the shock absorbers</li><li>• check and adjust level control valve</li><li>• double check if the air spring fits the OE part number</li></ul>    |
|   | <p><b>Abrasion</b></p> <ul style="list-style-type: none"><li>• Bellows contact with chassis parts</li><li>• Bellows contact with foreign bodies</li></ul>   | <ul style="list-style-type: none"><li>• double check if the air spring fits the OE part number</li><li>• check regularly and remove foreign objects stuck between bellows and piston</li></ul> |
|  | <p><b>Air Spring bursting, broken piston</b></p> <ul style="list-style-type: none"><li>• overload (exceeding the maximum allowable pressure)</li></ul>  | <ul style="list-style-type: none"><li>• never exceed the maximal allowed weight of the vehicle</li></ul>   |



### PREVENTIVE MAINTENANCE PROCESS FOR AIR SPRING

THE FOLLOWING ITEMS CAN BE ASSESSED WHEN THE VEHICLE IS UNDERGOING PERIODIC OR PREVENTIVE MAINTENANCE.

**CAUTION:** Never service the air suspension when the air bags are inflated.

- 01** Inspect the outer surface of the bag. Look for signs of uneven wear or cracks due to heating.
- 02** Inspect the compressed air hoses to make sure there is no contact between them and the outer surface of the spring. Air hoses can cause (due to friction) wear on the bellows in a short space of time.
- 03** Check that there is sufficient clearance around the air spring when it is at its maximum diameter, avoiding contact with other metal components.
- 04** Inspect the external surface of the base piston for the external surface of the base piston to check for any build-up of material (e.g. stones, sand, earth, etc.). In a cylindrical spring, the base piston is the lower component under which the bag acts.
- 05** The correct height of the chassis must be maintained. All vehicles with air suspension have the correct chassis height specified by the manufacturer. This height must be maintained within a specified tolerance. This dimension can be inspected with the vehicle loaded or empty.
- 06** Levelling control valves are very important and ensure that the system as a whole works as designed. Clean, inspect and replace if necessary.
- 07** Make sure the vehicle is equipped with suitable shock absorbers, and check for leaking hydraulic fluid or broken and/or damaged connectors. If you find any broken shock absorbers, replace them immediately. The shock absorber normally limits the action of the air spring, preventing the spring from disengaging due to excessive opening.
- 08** Check the torque of all the bolts and nuts used to assemble the air suspension system. If they are inadequate, retighten them according to the manufacturer's specifications, without over-tightening. Information on the appropriate torque can be found on the Firestone product label.
- 09** For cleaning, we recommend using soap and water, methyl, ethyl or isopropyl alcohol. Do not use organic solvents, abrasives or a cleaning system that uses pressurised steam.

This inspection process can be carried out in just a few minutes. If any of the conditions listed above are found, take the appropriate corrective action; this will save time and money.

# 得尔福公司信息